

OG-12G-AM

openGear Card

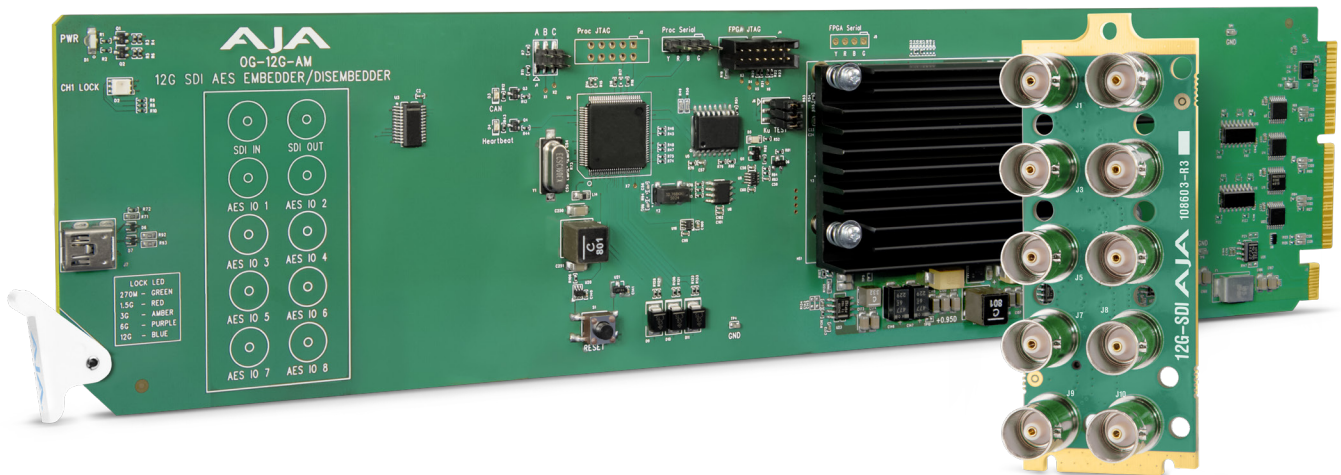

Installation and Operation Guide

Version 1.0
Published September 15, 2023



Notices

Trademarks

AJA® and Because it matters.® are registered trademarks of AJA Video Systems, Inc. for use with most AJA products. AJA™ is a trademark of AJA Video Systems, Inc. for use with recorder, router, software and camera products. Because it matters.™ is a trademark of AJA Video Systems, Inc. for use with camera products.

Corvid Ultra®, Io®, Ki Pro®, KONA®, KUMO®, ROI® and T-Tap® are registered trademarks of AJA Video Systems, Inc.

AJA Control Room™, KiStor™, Science of the Beautiful™, TruScale™, V2Analog™ and V2Digital™ are trademarks of AJA Video Systems, Inc.

All other trademarks are the property of their respective owners.

Copyright

Copyright © 2023 AJA Video Systems, Inc. All rights reserved. All information in this manual is subject to change without notice. No part of the document may be reproduced or transmitted in any form, or by any means, electronic or mechanical, including photocopying or recording, without the express written permission of AJA Video Systems, Inc.

Contacting AJA Technical Support or Sales

Please have all pertinent information at hand prior to contacting AJA support or sales.

Support Telephone: +1.530.271.3190

Support Website: <https://www.aja.com/support/contact>

Support Email: support@aja.com

Sales Email: sales@aja.com

Shipping Address: AJA Video Systems
180 Litton Drive
Grass Valley, CA 95945, USA

Contents

Notices	2
Trademarks	2
Copyright	2
Contacting AJA Technical Support or Sales	2
Chapter 1 – Introduction	4
Card Overview	4
Features	4
OG-12G-AM Simplified Block Diagram	5
I/O Connections for OG-12G-AM	5
Signal Indicators on the OG-12G-AM Card	5
Signal Indicators in the DashBoard Control System	6
User Controls	7
DashBoard Control System	7
openGear and AJA	8
Installation	8
Summary	8
Unpacking	8
OG-12G-AM Rear Plate Installation	8
OG-12G-AM Card Installation	9
Cabling	11
Chapter 2 – Operation	12
Default Operational Settings	12
Using the DashBoard Control System	12
Requirements	12
Configuration Settings Stored in OG Card	12
Control Interface Basic Components	13
Basic Tree View of Frames and Cards	13
Card Information and Status	13
Parameter Controls	15
Input Tab Screen	16
Output Tab Screen	16
Audio X-Point Tab Screen	17
Audio SRC Tab Screen	18
Sample Rate Converter	18
Setup Tab Screen	19
Uploading New Software	19
Rebooting	21
Appendix A – Specifications	23
OG-12G-AM Tech Specs	23
Appendix B – Safety and Compliance	25
5 Year Warranty and Liability Information	34
Index	35

Chapter 1 – Introduction

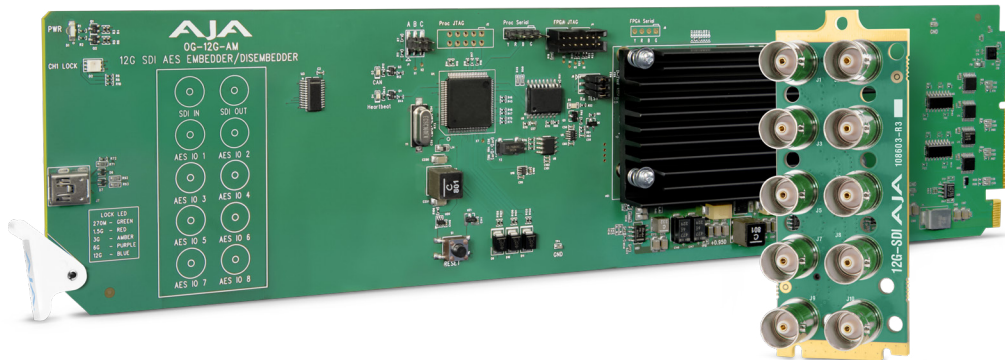

Card Overview

The OG-12G-AM is a 16 channel AES audio embedder/disembedder. AES audio can be embedded and disembedded simultaneously. The embedder and disembedder are user selectable, on a channel pair basis, to either “pass” existing SDI input audio or embed AES input audio through the back panel. Horizontal ancillary data (HANC) packets in compliance with SMPTE 291M can also be dropped at the input.

The OG-12G-AM automatically detects and configures to the input video standard. 12G-SDI formats up to and including 4096x2160p 60 YCbCr 4:4:2 are supported (see ["OG-12G-AM Tech Specs" on page 23](#) for a complete listing). The SDI output has minimal video latency and supports up to 16 channels of embedded audio.

NOTE: 2048x1080p/psf 29.97 and 30 formats support a maximum of 8 channels embedded audio.

Using the DashBoard application, you can configure data packets to be passed from the AES inputs to embedded ancillary packets un-altered. This, along with minimized embed/disembed latency, ensures 100 percent compatibility with Dolby® bitstreams and other non-PCM data.

Features

- openGear compatible card (requires 2 slots, rear card included)
- Use with openGear 2RU frames
- Controlled by DashBoard network control software
- 12G, 6G, 3G, HD, and SD-SDI embedder/disembedder
- 16 Channel AES audio
- 1x BNC 12G-SDI input
- 1x BNC 12G-SDI output
- 8x BNC AES configurable I/O
- Setup via DashBoard network control software
- Hot-swap capable
- Five-year international warranty with unlimited technical support

OG-12G-AM Simplified Block Diagram

Figure 1. OG-12G-AM Block Diagram

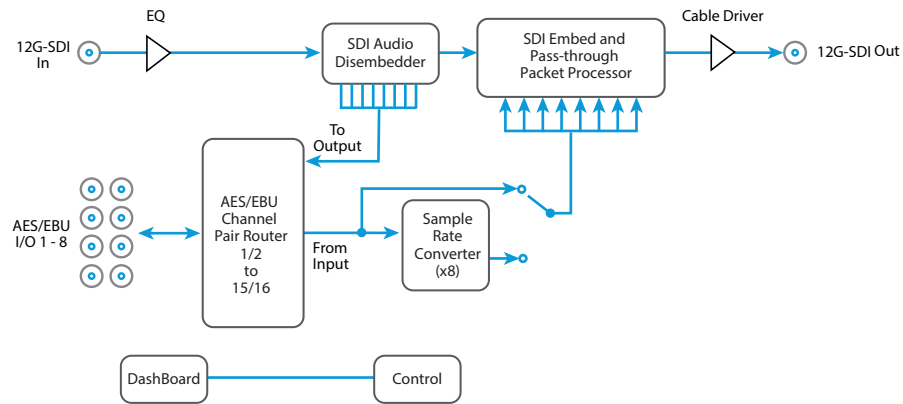

I/O Connections for OG-12G-AM

Figure 2. Rear View of OG-12G-AM Rear Plate Connectors

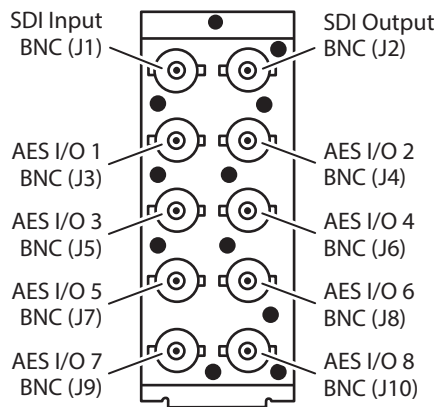

Signal Indicators on the OG-12G-AM Card

Located at the upper front area of the OG-12G-AM card, the Lock LED indicates by color the type of signal detected by the SDI input (Table 1).

Table 1. SDI In Lock LED Signal Detected

Signal Detected	Color
No Signal	Off
270M	Green
1.5G	Red
3G	Amber
6G	Purple
12G	Blue

Signal Indicators in the DashBoard Control System

Card Alarm State – Red

This potential card state will result in a red alarm indicator:

- HW Status Unsupported Rear Module

Card Alarm State – Yellow

When the input signal is not present, the DashBoard Control System shows a yellow Card State alarm: "Signal Lock Not Locked." Additionally, under the Status tab, the Signal Lock status is shown as "Not Locked," and the Input Signal is shown as "No Video."

Figure 3. Signal not present or not locked

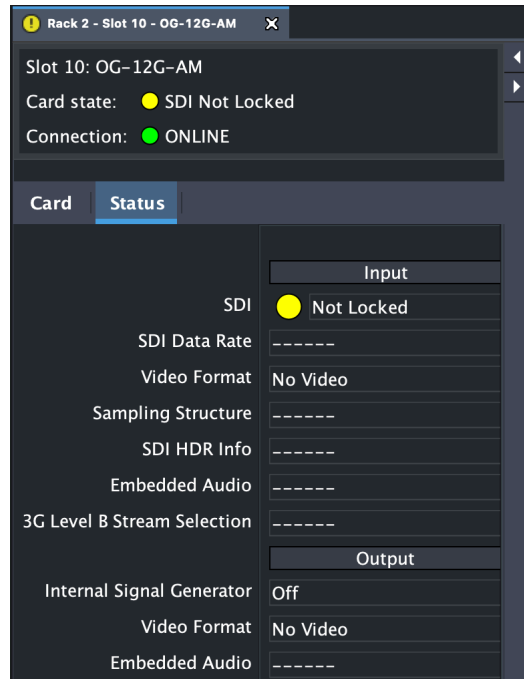

Card Alarm State – Green

When there is a valid input signal detected, the DashBoard Control System shows a green Card State. Additionally, under the Status tab, the Signal Lock is shown as "Locked," and the Input Signal field shows the resolution of the signal detected.

Figure 4. Signal Present and Locked

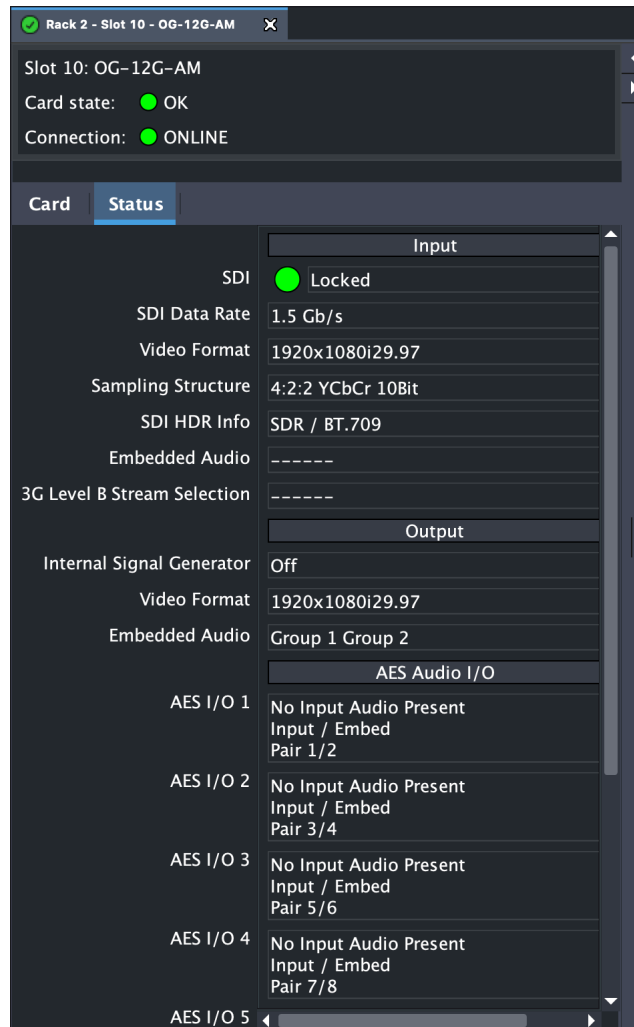

User Controls

DashBoard Control System

The DashBoard Control System, created by Ross Video, provides a control interface between Windows, macOS and Linux computers and the cards installed in an openGear frame. DashBoard operates through TCP/IP communication and requires an Ethernet connection between the controlling computer and an openGear frame.

For details about acquiring and using the DashBoard Control System, refer to ["Using the DashBoard Control System" on page 12.](#)

openGear and AJA

openGear is an open-architecture, modular frame system designed by Ross Video and supported by a diverse range of terminal equipment manufacturers, including AJA. Ross Video manufactures the frames, power supplies and network cards for openGear. AJA is a reseller of the openGear frames.

AJA Video is a leading manufacturer of video interface technologies, converters, digital video recording solutions and professional cameras, bringing high-quality, cost-effective products to the professional, broadcast and post-production markets. AJA products, including openGear cards, are designed and manufactured at our facilities in Grass Valley, California.

Installation

Summary

Installing an OG-12G-AM card into an OG-X-FR openGear frame consists of the following steps:

- Install the rear plate onto the back of the frame corresponding to the slot pair you will be using for the OG-12G-AM card.
- Insert the OG-12G-AM card into the frame in the right (even numbered) slot of the pair.
- Connect the BNC cabling to the rear plate.



ESD Susceptibility - Static discharge can cause serious damage to sensitive semiconductor devices. Avoid handling circuit boards in high static environments such as carpeted areas, and when wearing synthetic fiber clothing. Always exercise proper grounding precautions when working on circuit boards and related equipment.

Unpacking

Unpack each openGear product you received from the shipping container and ensure that all items are included. If any items are missing or damaged, contact your sales representative or AJA directly.

Parts List

<i>Quantity</i>	<i>Description</i>
1	OG-12G-AM Front Card in ESD bag
1	10 BNC Rear Plate

OG-12G-AM Rear Plate Installation

1. Ensure that the chassis is properly installed in a secure rackframe.
2. Locate the card frame slot on the rear of the openGear frame into which you wish to install the openGear card.

NOTE: An OG-12G-AM card occupies two slots in the frame.

3. Using a Phillips screwdriver, unscrew the top screw from the desired blank rear plate and remove it.
4. Seat the bottom of the rear plate in the seating slot at the base of the frame back plane ([Figure 5](#)).

Figure 5. Inserting Rear Plate Into Frame Seating Slot

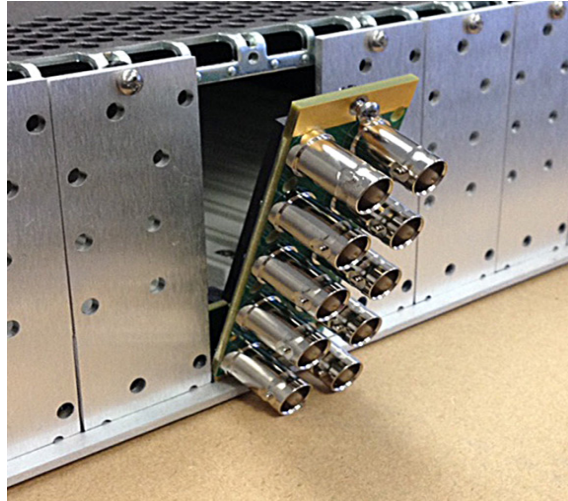

5. Align the top screw of the rear plate with the screw hole on the top edge of the frame back plane.
6. Ensure the rear plate aligns with the desired card slot before tightening the screw.
7. Using a Phillips screwdriver, fasten the rear plate to the frame back plane ([Figure 6](#)). Do not over tighten.

Figure 6. Rear Plate Inserted Into Frame Seating Slot

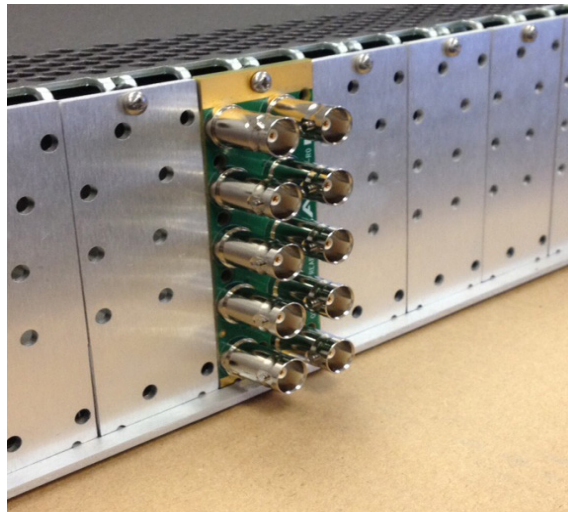

8. Ensure proper frame cooling and ventilation by having all rear frame slots covered with either OG card rear plates or blank metal plates.

OG-12G-AM Card Installation

1. Open the openGear frame door as follows:
 - A. Gently pull the side door tabs towards the center of the door, releasing the door from the frame.
 - B. Using both hands, pull the door towards you. The door extender arms prevent the door from falling.
2. Locate the rear plate you installed as described above. The interior slot number is dependent on the slot combinations into which you installed the

rear plate. This allows adequate spacing to avoid damaging the card, the cards installed in the neighboring slots, or both.

3. Hold the card by the edges and carefully align the card edges with the rails inside the frame. The slots are numbered starting from the left-most slot when facing the frame front.

IMPORTANT: OG-12G-AM cards are installed into the right (even numbered) slot of the pair in order to connect with the rear plate.

4. Insert the card into the frame until the card is properly seated in the Rear Plate. After you feel the card's first click, its position in the frame will resemble [Figure 7](#).

Figure 7. Card on Right Not Fully Inserted



5. Next, press against the white plastic tab again until you feel the second click. Make sure that the plastic tab at the bottom of the front edge of the card is completely upright. If it is tilting forward, the card is not yet fully inserted. A properly seated card position should resemble [Figure 8](#).

Figure 8. Card Fully Inserted, White Plastic Tab Upright

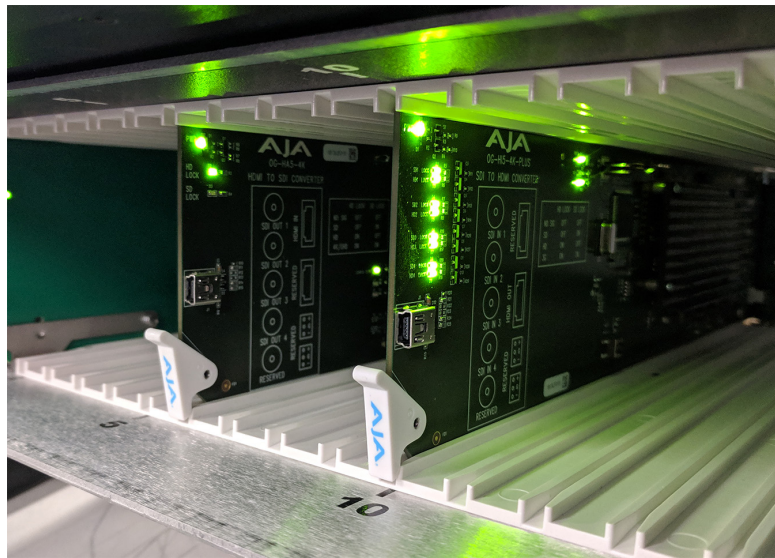

6. Some OG cards require more pressure than others to be fully inserted. Do not apply excessive force if you cannot completely insert the card into its slot.

7. Close the frame door as follows:
 - A. Slide the door into the frame.
 - B. Pull and release the door tabs to ensure the frame door is securely locked to the frame.

Cabling

Refer to [Figure 2 on page 5](#) to identify the input and output signal connectors.

Chapter 2 – Operation

Default Operational Settings

The OG-12G-AM ships from the factory with the following configuration:

- Input AES audio channel pairs on connectors AES I/O 1, 2, 3, and 4 are embedded in to SDI output channel pairs 1/2, 3/4, 5/6, and 7/8, overwriting any existing embedded audio.
- Input SDI embedded audio channel pairs 1/2, 3/4, 5/6, 7/8 are disembedded to AES audio channel pairs on connectors AES I/O 5, 6, 7, and 8
- All HANC packets pass from SDI input to output, except for embedded output audio channels 1/2, 3/4, 5/6, 7/8.

If these settings apply to your requirements, you can simply connect the video and audio input and output signal cables and power up the unit.

For other applications, you can configure the card using the DashBoard Control System.

Using the DashBoard Control System

The DashBoard Control System is available as a free download from the openGear DashBoard Software Download webpage:

<https://www.opengear.tv/frame-and-control/control-system/download/>

Ross Video offers comprehensive documentation that covers the extensive capabilities of the DashBoard Control System:

<https://www.rossvideo.com/support/product-documentation/dashboard/>

This AJA OG-12G-AM manual addresses only those essential aspects of the DashBoard Control System needed to control the OG-12G-AM card.

Requirements

The DashBoard Control System requires the following components:

- openGear frame with a Frame Controller card
- Ethernet connection between the controlling computer and the openGear frame

NOTE: The openGear frame ships from AJA with the MFC-8322-S Frame Controller card for controlling the new AJA DashBoard cards. The openGear frame also supports the MFC-OG3-N Advanced Networking Frame Controller card, which can be used to control compatible OG cards.

DashBoard automatically discovers openGear and DashBoard Connect devices, such as openGear frames and cards that are present and accessible on your network.

Configuration Settings Stored in OG Card

Configuration settings made through DashBoard are stored in the OG-12G-AM unit through subsequent power cycles.

Control Interface Basic Components

The basic components of the DashBoard Control System user interface consist of the basic tree view of frames and cards, the card information and status panel, and the parameter controls panel. These elements are shown below.

Figure 9. Main Sections of the DashBoard User Interface

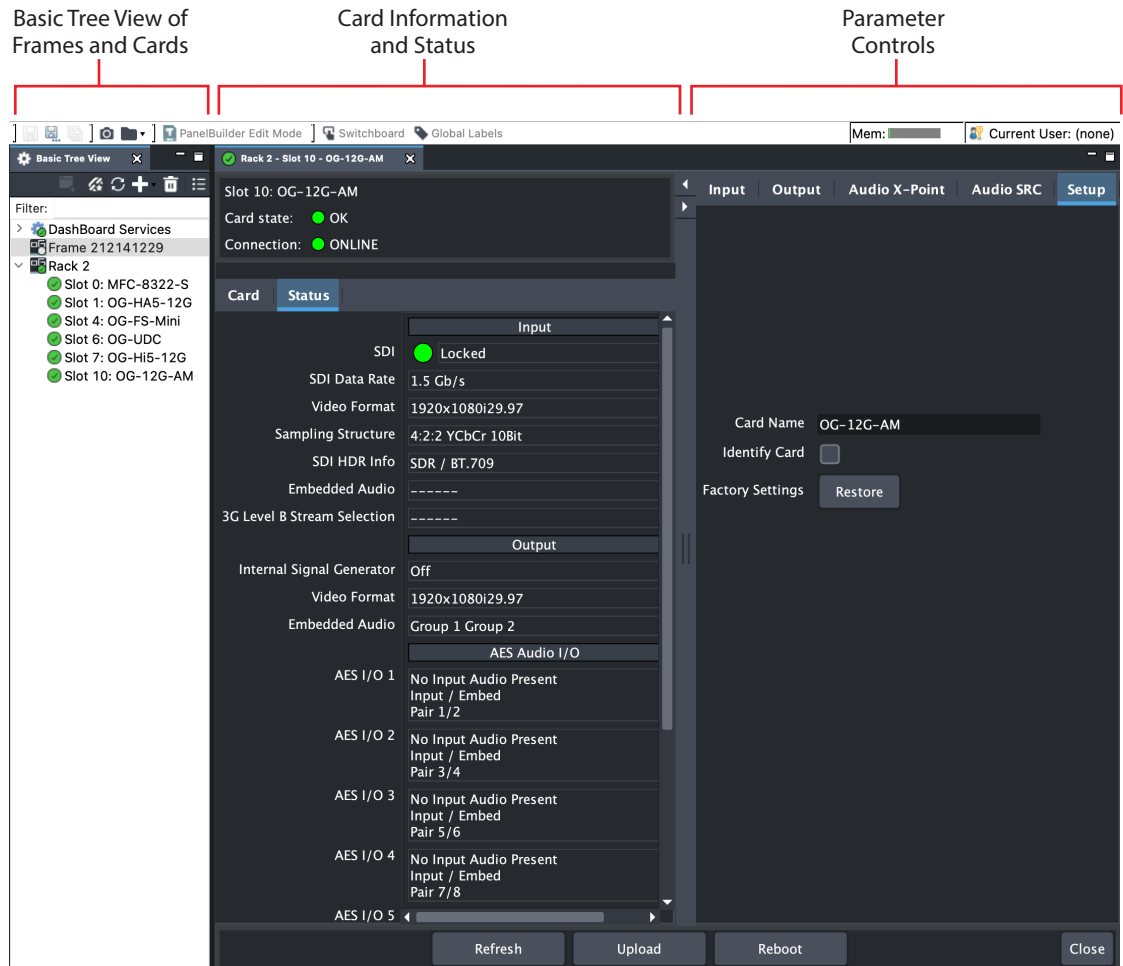

Basic Tree View of Frames and Cards

The basic tree view in the left column shows the frames and cards that are discoverable by DashBoard on your network.

Card Information and Status

The card information and status panel, shown in the middle panel, display the basic status of the card currently selected in DashBoard. The yellow fields in this panel indicate that they are read-only.

Card Information Screen

Figure 10. OG-12G-AM Card Information Screen in Dashboard

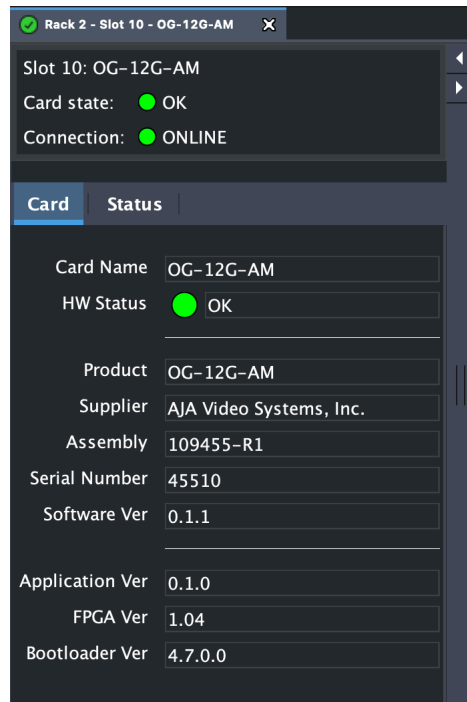

The Card information screen indicates the basic information about the card itself such as the card name, hardware status, serial number, software version and other items.

Status Information Screen

Figure 11. OG-12G-AM Status Information Screen in DashBoard

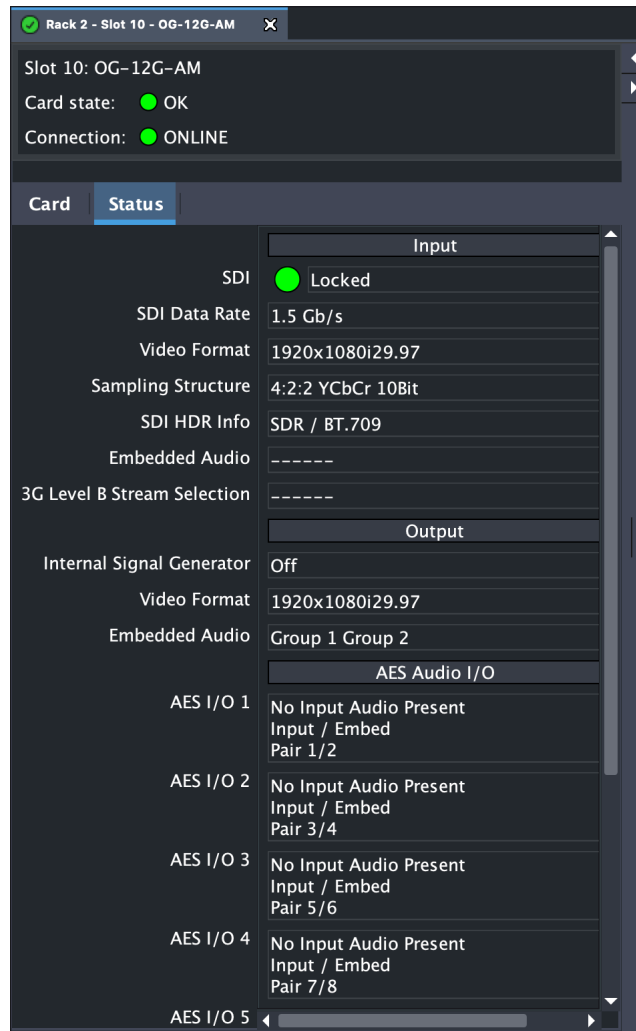

The Status information screen indicates the status of key aspects of signal presence such as Signal Lock, SDI Signal Type, Input Signal, Output Signal, and which groups are present in the ingoing and outgoing embedded audio.

The AES Audio Inputs section reports the presence of AES audio for AES input and output pairs. Refer to ["I/O Connections for OG-12G-AM" on page 5](#) to see the corresponding BNC inputs.

Parameter Controls

The parameter controls panel on the right side of DashBoard shows the tabs and parameters that are configurable for the selected card.

Input Tab Screen

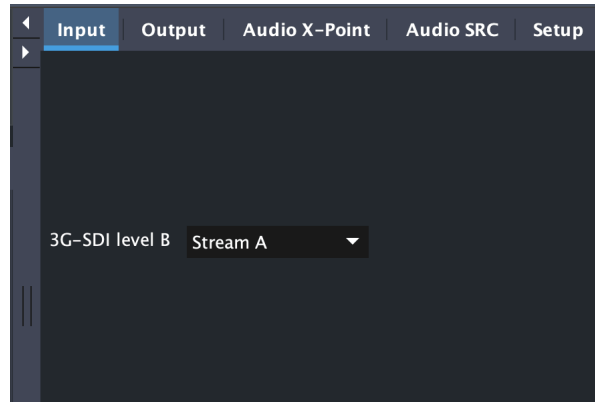

Click on the Input tab to view and make changes to the converter's input settings.

3G-SDI Level B:

When a 3G-SDI Level B DS (Dual Stream) signal is detected, use this control to select which input video stream the unit will disembed audio from—Stream A or Stream B. This setting also controls whether output video Stream A or Stream B will receive embedded audio.

NOTE: This control has no effect if a 3G-SDI Level B-DS signal is not detected.

Output Tab Screen

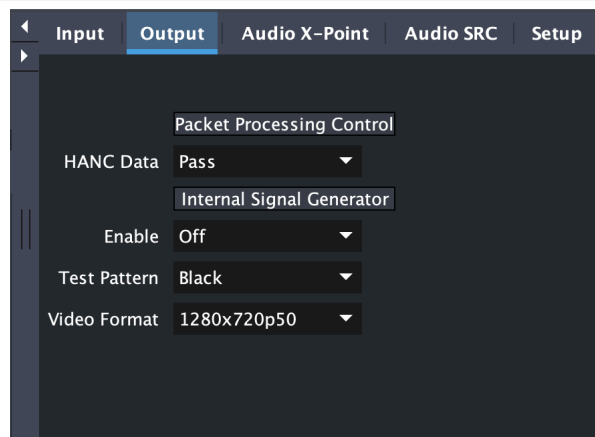

Packet Processing Control

HANC Data

- Pass - All incoming HANC packets are passed unless the embedder settings require all or part of them to be over-written.
- Remove - All incoming HANC packets are dropped before embedding any new audio packets. The embedder settings determine all embedded audio output. Disembedding is not affected.

Internal Signal Generator

The Output tab features an internal video signal generator (Black, 100% Color BVars, or Grey), and the video format of the video signal can be set.

Audio X-Point Tab Screen

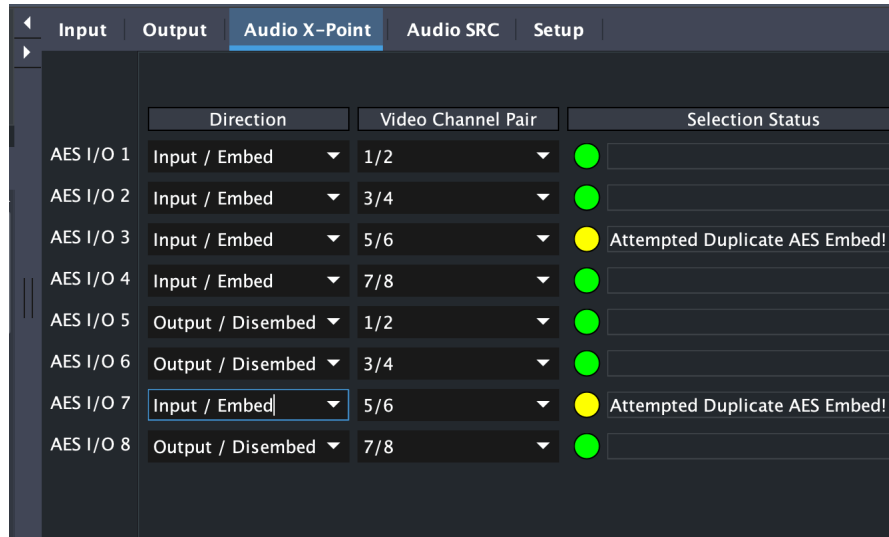

Direction

Select from the drop down menu to assign the signal direction of the corresponding AES I/O BNC. Select from:

- Input/Embed
- Output/Disembed
- Unused

Video Channel Pair

Select from the drop down menu any AES channel pair to be assigned for Input/Embed or Output/Disembed for the corresponding AES I/O BNC.

Selection Status

When valid selections are made, a green circle will be present and the box will remain empty.

When invalid selections are made (such as assigning different AES inputs to the same Video Channel Pair) the circle will turn yellow, and the following warning message will appear: " Attempted Duplicate AES Embed

NOTE: The factory default is AES I/O's 1, 2, 3, 4 set to Input/Embed with the Video Channel Pairs set respectively to 1/2, 3/4, 5/6, 7/8, and the AES I/O's 5, 6, 7, 8 are set to Output/Disembed with the Video Channel Pairs set to 1/2, 3/4, 5/6, 7/8.

NOTE: When duplicate AES embedding is detected, both selections are set to "Unused" until the conflict is resolved. This is shown in the "AES Audio I/O" under the "Status" tab on the left of the screen.

Audio SRC Tab Screen

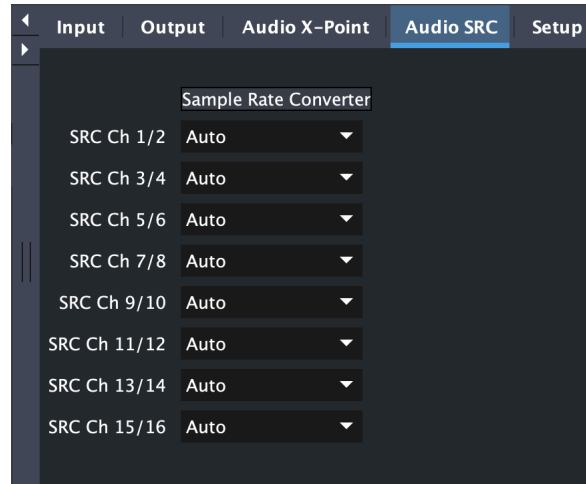

Click on the Audio SRC tab to view and make changes to the packet processing and set the Sample Rate Converter.

Sample Rate Converter

This setting determines whether AES audio inputs are passed through the sample rate converter before embedding. Turn this setting Off for compatibility with non-PCM bitstreams such as Dolby-E.

Choose Auto, On, or Off for each of the input channel pairs (Ch1/2 through Ch15/16).

- Auto - Automatically selects whether incoming AES audio is sample rate converted. If channel status bits are detected that indicate the audio is PCM (normal digital audio), the audio will be passed through the sample rate converter. If compressed audio (such as Dolby) bits are detected, the sample rate converter is bypassed (it would corrupt the compressed data).
- On - Pass all input AES audio through the sample rate converter before embedding (for example, for use with PCM audio). AES inputs are sample rate converted to a 48KHz rate synchronous to the video input.
- Off - Do not pass any input AES audio through the sample rate converter before embedding (for example, Dolby® Digital from a synchronous source).

NOTE: For proper operation with SRC Off, the AES input timing must be externally synchronized to the input SDI.

About SRC Settings

48KHz synchronous ancillary packets are disembedded and passed unaltered to the AES outputs regardless of the SRC setting. With the SRC setting Off, data packets are passed from the AES inputs to embedded ancillary packets unaltered, according to SMPTE 337M. All AES3-2003 defined channel status bits are passed through unaltered in both the embed and dis-embed directions—except for the sample rate field, which is always set to 48KHz. The channel status CRC is re-calculated and inserted into the bitstream.

Setup Tab Screen

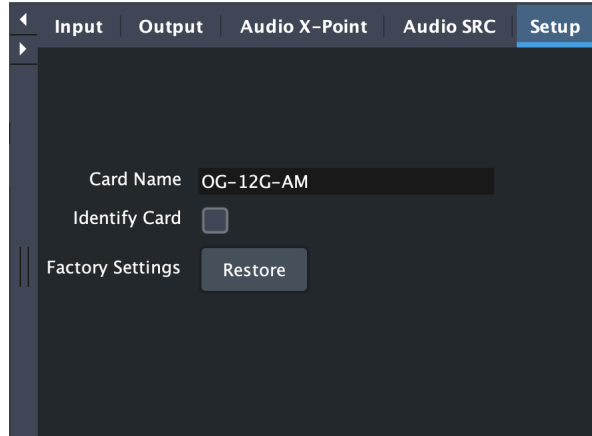

Click on the Setup tab to view and make changes to the card name or to restore card settings to factory default values.

Card Name - By default, this field is pre-populated with the card name OG-12G-AM. You can change the card name by editing the text in the Card Name field.

NOTE: Changing the Card Name in the Setup tab also changes the name of the card in the DashBoard tree view.

Identify Card- This feature is especially useful for identifying a specific card when you are working with numerous cards / frames. Click the checkbox to turn on Identify Card. When enabled, the PWR LED located at the front top edge of the card will blink on and off with an orange/green color. When disabled (default) the PWR LED light illuminates a solid green color when the card is powered on.

Factory Settings - If you would like to revert the card settings to factory default values, click **Restore**.

Uploading New Software

When available, you can upload updated software to the OG-12G-AM through the DashBoard Control System by following the steps below.

To Upload New Software

1. Check the AJA website for new software for your OG-12G-AM. If new software is found, download it and uncompress the file archive (zip).
2. Click the Upload button in the lower panel of the DashBoard Control System to open the Upload Software Wizard.

Figure 12. OG-12G-AM Upload Software Wizard window in Dashboard

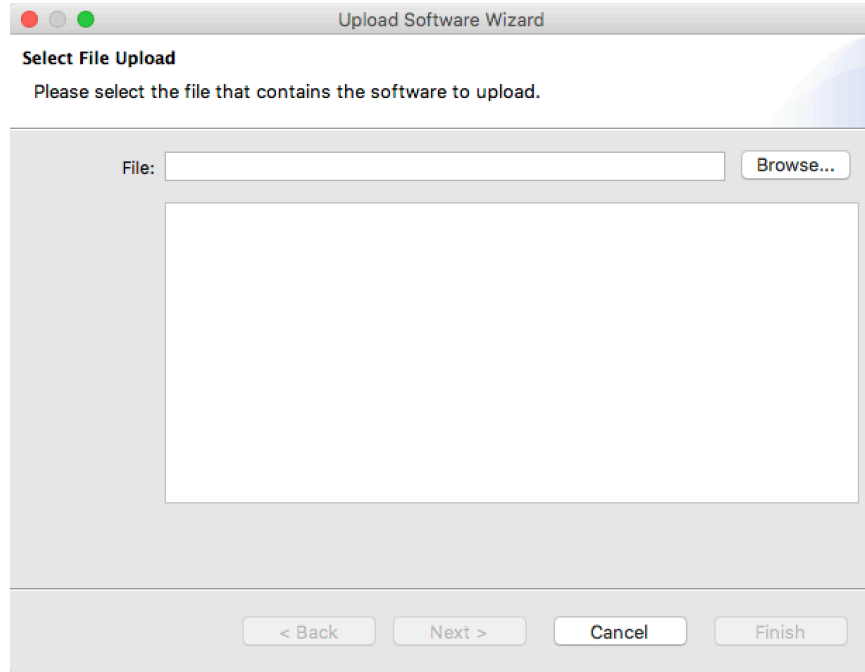

3. From the Upload Software Wizard window, select **Browse**.
4. Navigate to the location of the downloaded .bin file containing the software update. Select the .bin file, then select **Open**. The Upload Software Wizard window displays characteristics of the selected file for uploading.
5. Click **Finish**. The uploading process begins.

Figure 13. OG-12G-AM Uploading to Selected Devices window in Dashboard

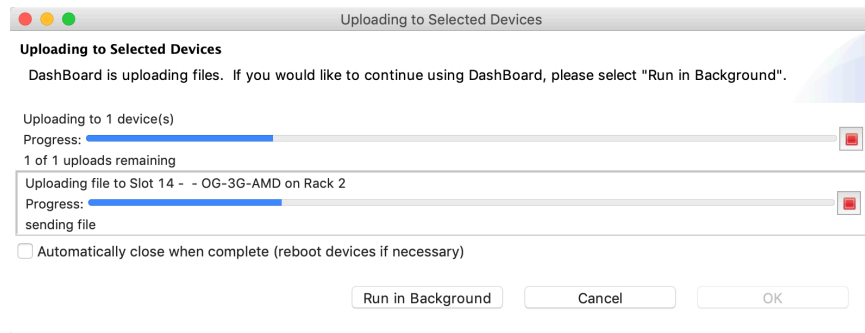

6. When the progress bar indicates that the uploading is finished and status indicates "Complete," click **OK**.
7. To verify the version of software or firmware currently installed on your card, select the Card tab from the center panel of Dashboard.

Figure 14. OG-12G-AM Card Tab Screen Showing Installed Software Version

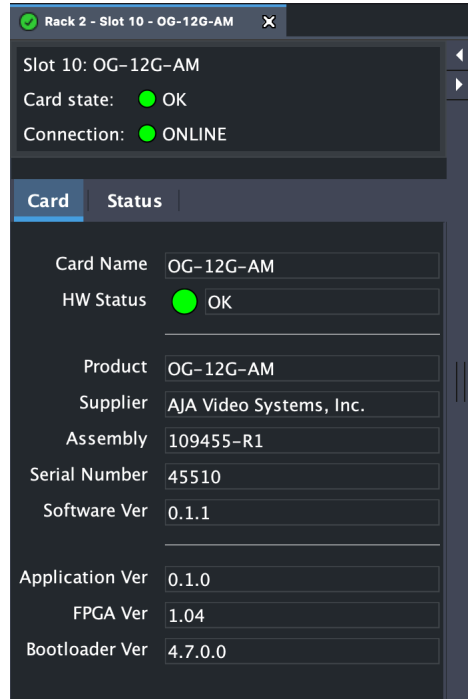

Rebooting

Rebooting is a standard function built in to the DashBoard Control System, and should only be performed if the board has become unresponsive.

WARNING: During a reboot, any card operations will be briefly interrupted, but will be restored once the reboot has completed.

To Reboot the OG-12G-AM

1. Click the Reboot button in the lower panel of DashBoard. The reboot confirmation message displays.

Figure 15. Reboot confirmation window

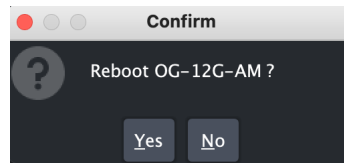

2. Click **Yes**. The message "Loading data, please wait. Refreshing device data" displays for a moment. The card will be offline for a few seconds, and any current operations will be interrupted.

Figure 16. The OG-12G-AM briefly pauses operations while rebooting

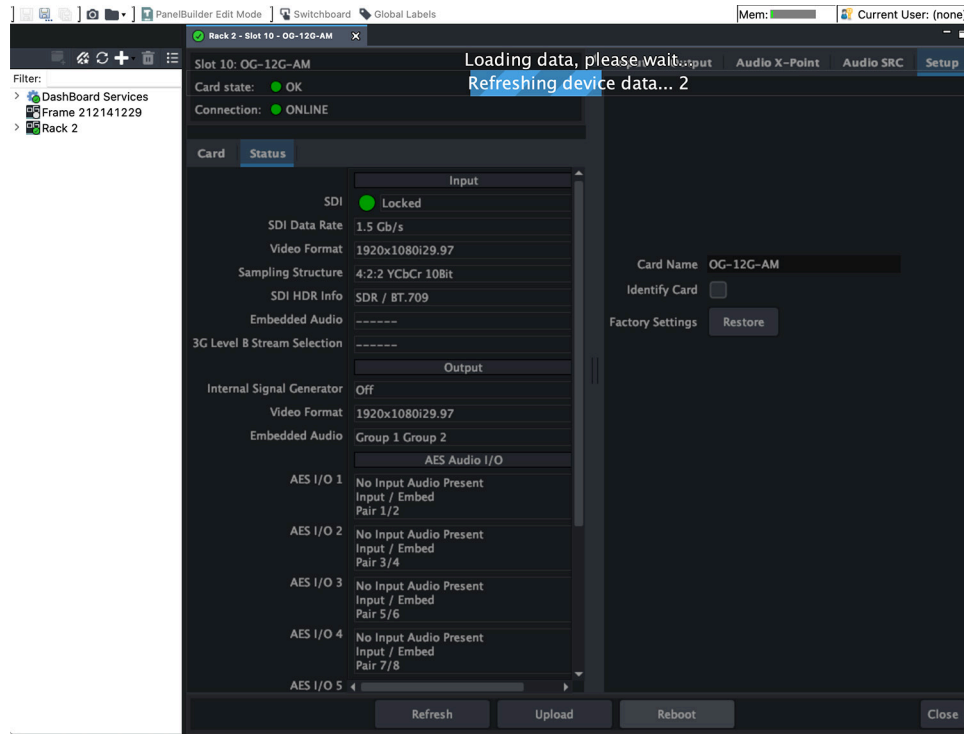

3. Following a Reboot operation, the board configuration will return to the settings that were in place at the time of rebooting.

Appendix A – Specifications

OG-12G-AM Tech Specs

Video Formats

- (4K) 4096x2160p 23.98, 24, 25, 29.97, 30, 47.95, 48, 50, 59.94, 60
- (UltraHD) 3840x2160p 23.98, 24, 25, 29.97, 30, 50, 59.94, 60
- (2K) 2048x1080p 23.98, 24, 25, 29.97, 30, 47.95, 48, 50, 59.94, 60
- (HD) 1920x1080p 23.98, 24, 25, 29.97, 30, 50, 59.94, 60
- (HD) 1920x1080i 50, 59.94, 60
- (HD) 1280x720p 50, 59.94, 60
- (SD) 625i 50
- (SD) 525i 59.94
- RGB and YCbCr, 4:4:4/4:2:2, 10-bit

Note: Raster and frame rate dependent. Please see OG-12G-AM Video Formats in Documents and Manual.

Video Input Digital

- 1x 12G-SDI BNC, SMPTE 259/292/424/2081/2082
 - Single Link SD/HD/2K/UltraHD/4K
 - Single Link 3G-SDI Level A or B DL, SMPTE 425

Video Output Digital

- 1x 12G-SDI BNC, SMPTE 259/292/424/2081/2082
 - Single Link SD/HD/2K/UltraHD/4K
 - Single Link 3G-SDI Level A or B-DL, SMPTE 425

Video Path Delay

Video Out is a delayed, relocked version of Video In, at same frame rate, etc. Video Out is undefined when no input.

- Video Latency, time measured between video input and video output connector:
 - 12G = 4 μ sec
 - 6G = 4 μ sec
 - 3G level A = 4 μ sec
 - 3G level B = 8 μ sec
 - HD (1.5 Gb) = 8 μ sec
 - SD (270 Mb) = 22 μ sec

Audio Inputs and Outputs Digital

- AES PCM audio, 8x BNC, up to 16-channels in, 16-channels out, selectable in pairs

Audio Data Formats

- AES3-2003

Embedded Audio

- SMPTE 272M (SD): 20-bit, 48 kHz synchronous
- SMPTE 299M (3G/HD): 24-bit, 48 kHz synchronous
- Incoming embedded audio can be passed, removed, or overridden
- Up to 16-channels supported

Note: 2048x1080p/PsF 29.97 and 30 formats support a maximum of 8-channels embedded audio.

Embed Path Audio Latency

(Time measured between audio input and video output connector):

- 1500 μ sec (SRC ON)
- 400 μ sec (SRC OFF)

Disembed Path Audio Latency

(Time measured between video input and audio output connector):

- 210 μ sec

User Interface

- openGear DashBoard network control software via Windows, macOS, or Linux

Size (w x d x h)

- openGear standard form factor, front slot and rear card
- Two slots required for each card

Weight

- 0.5 lb (0.3 kg)

Power

- openGear frame compatible, 10.0 watts max per card

Environment

- Safe Operating Temperature: 0 to 40 C (32 to 104 F)
- Safe Storage Temperature (Power OFF): -40 to 60 C (-40 to 140 F)
- Operating Relative Humidity: 10-90% noncondensing
- Operating Altitude: <3,000 meters (<10,000 feet)

Appendix B – Safety and Compliance

Federal Communications Commission (FCC) Compliance Notices

Class A Interference Statement

This equipment has been tested and found to comply with the limits for a Class A digital device, pursuant to Part 15, Subpart B of the FCC Rules. These limits are designed to provide reasonable protection against harmful interference in a residential installation. This equipment generates, uses, and can radiate radio frequency energy and, if not installed and used in accordance with the instructions, may cause harmful interference to radio communications. However, there is no guarantee that interference will not occur in a particular installation. If this equipment does cause harmful interference to radio or television reception, which can be determined by turning the equipment off and on, the user is encouraged to try to correct the interference by one or more of the following measures:

- Reorient or relocate the receiving antenna.
- Increase the separation between the equipment and receiver.
- Connect the equipment into an outlet on a circuit different from that to which the receiver is connected.
- Consult the dealer or an experienced radio/TV technician for help.

FCC Caution

This device complies with Part 15 of the FCC Rules. Operation is subject to the following two conditions: (1) This device may not cause harmful interference, and (2) this device must accept any interference received, including interference that may cause undesired operation.

Canadian ICES Statement

Canadian Department of Communications Radio Interference Regulations

This digital apparatus does not exceed the Class A limits for radio-noise emissions from a digital apparatus as set out in the Radio Interference Regulations of the Canadian Department of Communications. This Class A digital apparatus complies with Canadian ICES-003.

Règlement sur le brouillage radioélectrique du ministère des Communications

Cet appareil numérique respecte les limites de bruits radioélectriques visant les appareils numériques de classe A prescrites dans le Règlement sur le brouillage radioélectrique du ministère des Communications du Canada. Cet appareil numérique de la Classe A est conforme à la norme NMB-003 du Canada.

European Union and European Free Trade Association (EFTA) Regulatory Compliance

This equipment may be operated in the countries that comprise the member countries of the European Union and the European Free Trade Association. These countries, listed in the following paragraph, are referred to as The European Community throughout this document:

AUSTRIA, BELGIUM, BULGARIA, CYPRUS, CZECH REPUBLIC, DENMARK, ESTONIA, FINLAND, FRANCE, GERMANY, GREECE, HUNGARY, IRELAND, ITALY, LATVIA, LITHUANIA, LUXEMBOURG, MALTA, NETHERLANDS, POLAND, PORTUGAL, ROMANIA, SLOVAKIA, SLOVENIA, SPAIN, SWEDEN, UNITED KINGDOM, ICELAND, LICHTENSTEIN, NORWAY, SWITZERLAND

Declaration of Conformity

Marking by this symbol indicates compliance with the Essential Requirements of the EMC Directive of the European Union 2014/30/EU.



This equipment meets the following conformance standards:

Safety

EN 60065: 2014 (T-Mark License),

IEC 60065: 2014 (CB Scheme Report/Certificate)

Additional licenses issued for specific countries available on request.

Emissions

EN 55032: 2012 + AC: 2013, CISPR 32: 2015, EN 61000-3-2: 2014, EN 61000-3-3: 2013

Immunity

EN 55103-2: 2009, EN 61000-4-2:2009, EN 61000-4-3: 2006 + A1:2008 + A2:2010,

EN 61000-4-4: 2004 + A1:2010, EN 61000-4-5:2006, EN 61000-4-6:2009,

EN 61000-4-11:2004

Environments: E2, E3 and E4

The product is also licensed for additional country specific standards as required for the International Marketplace



Warning! This is a Class A product. In a domestic environment, this product may cause radio interference, in which case, the user may be required to take appropriate measures.

Achtung! Dieses ist ein Gerät der Funkstörgrenzwertklasse A. In Wohnbereichen können bei Betrieb dieses Gerätes Rundfunkstörungen auftreten, in welchen Fällen der Benutzer für entsprechende Gegenmaßnahmen verantwortlich ist.

Attention! Ceci est un produit de Classe A. Dans un environnement domestique, ce produit risque de créer des interférences radioélectriques, il appartiendra alors à l'utilisateur de prendre les mesures spécifiques appropriées.

Recycling Notice



This symbol on the product or its packaging indicates that this product must not be disposed of with your other household waste. Instead, it is your responsibility to dispose of your waste equipment by handing it over to a designated collection point for the recycling of waste electrical and electronic equipment. The separate collection and recycling of your waste equipment at the time of disposal will help conserve natural resources and ensure that it is recycled in a manner that protects human health and the environment. For more information about where you can drop off your waste for recycling, please contact your local authority, or where you purchased your product.

Korea KCC Compliance Statement

<p>A급 기기 (업무용 방송통신기자재)</p>	<p>이 기기는 업무용(A급) 전자파적합기기로서 판매자 또는 사용자는 이 점을 주의하시기 바라며, 가정외의 지역에서 사용하는 것을 목적으로 합니다.</p>
<p>Class A (Broadcasting Communication Equipment for Office Use)</p>	<p>As an electromagnetic wave equipment for office use (Class A), this equipment is intended to use in other than home area. Sellers or users need to take note of this.</p>

Taiwan Compliance Statement

警告使用者：
這是甲類的資訊產品，在居住的環境中使用時，可能會造成射頻干擾，在這種情況下，使用者會被要求採取某些適當的對策。

This is a Class A product based on the standard of the Bureau of Standards, Metrology and Inspection (BSMI) CNS 13438, Class A. In a domestic environment this product may cause radio interference in which case the user may be required to take adequate measures.

Japanese Compliance Statement

この装置は、クラスA情報技術装置です。この装置を家庭環境で使用すると電波妨害を引き起こすことがあります。この場合には使用者が適切な対策を講ずるよう要求されることがあります。 VCCI-A

This is a Class A product based on the standard of the VCCI Council (VCCI 32: 2016). If this equipment is used in a domestic environment, radio interference may occur, in which case, the user may be required to take corrective actions.

Translated Warning and Caution Messages

The following caution statements, warning conventions, and warning messages apply to this product and manual.



Warning Symbol



Hazard Symbol



Caution Symbol

Before Operation Please Read These Instructions



Warning! Read and follow all warning notices and instructions marked on the product or included in the documentation.

Avertissement! Lisez et conformez-vous à tous les avis et instructions d'avertissement indiqués sur le produit ou dans la documentation.

Warnung! Lesen und befolgen Sie die Warnhinweise und Anweisungen, die auf dem Produkt angebracht oder in der Dokumentation enthalten sind.

¡Advertencia! Lea y siga todas las instrucciones y advertencias marcadas en el producto o incluidas en la documentación.

Aviso! Leia e siga todos os avisos e instruções assinalados no produto ou incluídos na documentação.

Avviso! Leggere e seguire tutti gli avvisi e le istruzioni presenti sul prodotto o inclusi nella documentazione.



Warning! Do not use this device near water and clean only with a dry cloth.

Avertissement! N'utilisez pas cet appareil près de l'eau et nettoyez-le seulement avec un tissu sec.

Warnung! Das Gerät nicht in der Nähe von Wasser verwenden und nur mit einem trockenen Tuch säubern.

¡Advertencia! No utilice este dispositivo cerca del agua y límpielo solamente con un paño seco.

Aviso! Não utilize este dispositivo perto da água e limpe-o somente com um pano seco.

Avviso! Non utilizzare questo dispositivo vicino all'acqua e pulirlo soltanto con un panno asciutto.



Warning! Do not block any ventilation openings. Install in accordance with the manufacturer's instructions.

Avertissement! Ne bloquez aucune ouverture de ventilation. Suivez les instructions du fabricant lors de l'installation.

Warnung! Die Lüftungsöffnungen dürfen nicht blockiert werden. Nur gemäß den Anweisungen des Herstellers installieren.

¡Advertencia! No bloquee ninguna de las aberturas de la ventilación. Instale de acuerdo con las instrucciones del fabricante.

Aviso! Não obstrua nenhuma das aberturas de ventilação. Instale de acordo com as instruções do fabricante.

Avviso! Non ostruire le aperture di ventilazione. Installare in conformità con le istruzioni del fornitore.



Warning! Do not install near any heat sources such as radiators, heat registers, stoves, or other apparatus (including amplifiers) that produce heat.

Avertissement! N'installez pas l'appareil près d'une source de chaleur telle que des radiateurs, des bouches d'air de chauffage, des fourneaux ou d'autres appareils (amplificateurs compris) qui produisent de la chaleur.

Warnung! Nicht in der Nähe von Wärmequellen wie Heizkörpern, Heizregistern, Öfen oder anderen Wärme erzeugenden Geräten (einschließlich Verstärkern) aufstellen.

¡Advertencia! No instale cerca de fuentes de calor tales como radiadores, registros de calor, estufas u otros aparatos (incluidos amplificadores) que generan calor.

Aviso! Não instale perto de nenhuma fonte de calor tal como radiadores, saídas de calor, fogões ou outros aparelhos (incluindo amplificadores) que produzam calor.

Avviso! Non installare vicino a fonti di calore come termosifoni, diffusori di aria calda, stufe o altri apparecchi (amplificatori compresi) che emettono calore.



Warning! Refer all servicing to qualified service personnel. Servicing is required when the device has been damaged in any way, such as power-supply cord or plug is damaged, liquid has been spilled or objects have fallen into the device, the device has been exposed to rain or moisture, does not operate normally, or has been dropped.

Avertissement! Référez-vous au personnel de service qualifié pour tout entretien. L'entretien est exigé quand l'appareil a été endommagé de quelque manière que ce soit, par exemple lorsque le cordon d'alimentation ou la prise sont endommagés, que du liquide a été versé ou des objets sont tombés dans l'appareil, que l'appareil a été exposé à la pluie ou à l'humidité, ne fonctionne pas normalement ou est tombé.

Warnung! Das Gerät sollte nur von qualifizierten Fachkräften gewartet werden. Eine Wartung ist fällig, wenn das Gerät in irgendeiner Weise beschädigt wurde, wie bei beschädigtem Netzkabel oder Netzstecker, falls Flüssigkeiten oder Objekte in das Gerät gelangen, das Gerät Regen oder Feuchtigkeit ausgesetzt wurde, nicht ordnungsgemäß funktioniert oder fallen gelassen wurde.

¡Advertencia! Consulte al personal calificado por cuestiones de reparación. El servicio de reparación se requiere cuando el dispositivo ha recibido cualquier tipo de daño, por ejemplo cable o espigas dañadas, se ha derramado líquido o se han caído objetos dentro del dispositivo, el dispositivo ha sido expuesto a la lluvia o humedad, o no funciona de modo normal, o se ha caído.

Aviso! Remeta todos os serviços de manutenção para o pessoal de assistência qualificado. A prestação de serviços de manutenção é exigida quando o dispositivo foi danificado mediante qualquer forma, como um cabo de alimentação ou ficha que se encontra danificado/a, quando foi derramado líquido ou caíram objectos sobre o dispositivo, quando o dispositivo foi exposto à chuva ou à humidade, quando não funciona normalmente ou quando foi deixado cair.

Avviso! Fare riferimento al personale qualificato per tutti gli interventi di assistenza. L'assistenza è necessaria quando il dispositivo è stato danneggiato in qualche modo, ad esempio se il cavo di alimentazione o la spina sono danneggiati, è stato rovesciato del liquido è stato rovesciato o qualche oggetto è caduto nel dispositivo, il dispositivo è stato esposto a pioggia o umidità, non funziona correttamente o è caduto.



Warning! Disconnect the external AC power supply line cord(s) from the mains power before moving the unit.

Avertissement! Retirez le ou les cordons d'alimentation en CA de la source d'alimentation principale lorsque vous déplacez l'appareil.

Warnung! Trennen Sie die Wechselstrom-Versorgungskabel vom Netzstrom, bevor Sie das Gerät verschieben.

¡Advertencia! Cuando mueva la unidad desenchufe de la red eléctrica el/los cable(s) de la fuente de alimentación CA tipo brick.

Advertência! Remova os cabos CA de alimentação brick da rede elétrica ao mover a unidade.

Avvertenza! Scollegare il cavo dell'alimentatore quando si sposta l'unità.



Hazard! High Voltage. This situation or condition can cause injury due to electric shock.

Avertissement! Tension élevée. Cette situation ou condition peut causer des blessures dues à un choc électrique.

Warnung! Hochspannung. Diese Situation oder Bedingung kann zu Verletzungen durch Stromschlag führen.

¡Advertencia! Alto voltaje . Esta situación o condición puede causar lesiones debidas a una descarga eléctrica.

Aviso! Alta Tensão . Esta situação ou condição pode causar danos devido a choques elétricos.

Avviso! Alta tensione. Questa situazione o condizione può causare lesioni a causa di scosse elettriche.



Warning! Only use attachments and accessories specified and/or sold by the manufacturer.

Avertissement! Utilisez seulement les attaches et accessoires spécifiés et/ou vendus par le fabricant.

Warnung! Verwenden Sie nur Zusatzgeräte und Zubehör angegeben und / oder verkauft wurde durch den Hersteller.

¡Advertencia! Utilice solamente los accesorios y conexiones especificados y/o vendidos por el fabricante.

Aviso! Utilize apenas equipamentos/acessórios especificados e/ou vendidos pelo fabricante.

Avviso! Utilizzare soltanto i collegamenti e gli accessori specificati e/o venduti dal produttore.



Warning! Do not defeat the safety purpose of the polarized or grounding-type plug. A polarized plug has two blades with one wider than the other. A grounding type plug has two blades and a third grounding prong. The wide blade or the third prong are provided for your safety. If the provided plug does not fit into your outlet, consult an electrician for replacement of the obsolete outlet.

Avertissement! La sécurité de la prise polarisée ou de la prise de type mise à la terre ne doit en aucun cas être empêchée de fonctionner. Une prise polarisée a deux broches, l'une étant plus large que l'autre. Une prise de type mise à la terre a deux broches et une troisième broche pour la mise à la terre. La broche large ou la troisième broche sont fournies pour votre sécurité. Si la prise fournie ne s'insère pas dans votre prise femelle, consultez un électricien pour le remplacement de la prise femelle obsolète.

Warnung! Der Sicherheitszweck des gepolten bzw. Schukosteckers ist zu berücksichtigen. Ein gepolter Stecker verfügt über zwei Pole, von denen einer breiter als der andere ist. Ein Schukostecker verfügt neben den zwei Polen noch über einen dritten Pol zur Erdung. Der breite Pol bzw. der Erdungspol dienen der Sicherheit. Wenn der zur Verfügung gestellte Stecker nicht in Ihren Anschluss passt, konsultieren Sie einen Elektriker, um den veralteten Anschluss zu ersetzen.

¡Advertencia! No eche por tierra la finalidad del tipo de enchufe polarizado con conexión a tierra. Un enchufe polarizado tiene dos espigas, una más ancha que la otra. Un enchufe con conexión a tierra tiene dos espigas iguales y una tercera espiga que sirve para la conexión a tierra. La espiga ancha, o la tercera espiga, sirven para su seguridad. Si el enchufe suministrado no encaja en el tomacorriente, consulte con un electricista para reemplazar el tomacorriente obsoleto.

Aviso! Não anule a finalidade da segurança da ficha polarizada ou do tipo ligação terra. Uma ficha polarizada tem duas lâminas sendo uma mais larga do que a outra. Uma ficha do tipo de ligação à terra tem duas lâminas e um terceiro terminal de ligação à terra. A lâmina larga ou o terceiro terminal são fornecidos para sua segurança. Se a ficha fornecida não couber na sua tomada, consulte um electricista para a substituição da tomada obsoleta.

Avviso! Non compromettere la sicurezza della spina polarizzata o con messa a terra. Una spina polarizzata ha due spinotti, di cui uno più largo. Una spina con messa a terra ha due spinotti e un terzo polo per la messa a terra. Lo spinotto largo o il terzo polo sono forniti per motivi di sicurezza. Se la spina fornita non si inserisce nella presa di corrente, contattare un elettricista per la sostituzione della presa obsoleta.



Warning! Since the Mains plug is used as the disconnection for the device, it must remain readily accessible and operable.

Avertissement! Puisque la prise principale est utilisée pour débrancher l'appareil, elle doit rester aisément accessible et fonctionnelle.

Warnung! Da der Netzstecker als Trennvorrichtung dient, muss er stets zugänglich und funktionsfähig sein.

¡Advertencia! Puesto que el enchufe de la red eléctrica se utiliza como dispositivo de desconexión, debe seguir siendo fácilmente accesible y operable.

Aviso! Dado que a ficha principal é utilizada como a desconexão para o dispositivo, esta deve manter-se prontamente acessível e funcional.

Avviso! Poiché il cavo di alimentazione viene usato come dispositivo di sconnessione, deve rimanere prontamente accessibile e operabile.



Warning! Protect the power cord from being walked on or pinched particularly at plugs, convenience receptacles, and the point where they exit from the device.

Avertissement! Protégez le cordon d'alimentation pour que l'on ne marche pas dessus ou qu'on le pince, en particulier au niveau des prises mâles, des réceptacles de convenance, et à l'endroit où il sort de l'appareil.

Warnung! Vermeiden Sie, dass auf das Netzkabel getreten oder das Kabel geknickt wird, insbesondere an den Steckern, den Steckdosen und am Kabelausgang am Gerät.

¡Advertencia! Proteja el cable de energía para que no se le pise ni apriete, en especial cerca del enchufe, los receptáculos de conveniencia y el punto del que salen del equipo.

Aviso! Proteja o cabo de alimentação de ser pisado ou de ser comprimido particularmente nas fichas, em tomadas de parede de conveniência e no ponto de onde sai do dispositivo.

Avviso! Proteggere il cavo di alimentazione in modo che nessuno ci cammini sopra e che non venga schiacciato soprattutto in corrispondenza delle spine e del punto in cui esce dal dispositivo.



Warning! Unplug this device during lightning storms or when unused for long periods of time.

Avertissement! Débranchez cet appareil pendant les orages avec éclairs ou s'il est inutilisé pendant de longues périodes.

Warnung! Das Gerät ist bei Gewitterstürmen oder wenn es über lange Zeiträume ungenutzt bleibt vom Netz zu trennen.

¡Advertencia! Desenchufe este dispositivo durante tormentas eléctricas o cuando no se lo utilice por largos periodos del tiempo.

Aviso! Desconecte este dispositivo da tomada durante trovoadas ou quando não é utilizado durante longos períodos de tempo.

Avviso! Utilizzare soltanto i collegamenti e gli accessori specificati e/o venduti dal produttore, quali il treppiedi e l'esoscheletro.



Warning! Ensure Mains Power is disconnected before installing the OG-12G-AM modules into the frame, or installing and removing options. If a Mains switch is not provided, the power cord(s) of this equipment provide the means of disconnection. The socket outlet must be installed near the equipment and must be easily accessible.

Avertissement ! Avant d'installer des modules OG-12G-AM dans la structure, ainsi qu'avant d'installer ou d'enlever des options, assurez-vous d'avoir déconnecté l'alimentation électrique. S'il n'y a pas d'interrupteur électrique, il faut débrancher les câbles électriques de l'équipement. La prise électrique doit être située à proximité de l'équipement et doit être aisément accessible.

Achtung! Sicherstellen, dass die Netzleitung entkoppelt ist, bevor die OG-12G-AM Module in das Gestell eingebaut oder Wahlteile eingebaut bzw. ausgebaut werden. Wenn kein Netzschalter vorgesehen ist, dient das bzw. dienen die Netzkabel dieser Vorrichtung als Entkopplungsmittel. Die Steckdose muss in der Nähe der Vorrichtung installiert und leicht zugänglich sein.

Avvertenza. Accertarsi che l'alimentazione di rete sia scollegata prima di installare i moduli OG-12G-AM nel frame o di installare e rimuovere componenti opzionali. Se non è presente un interruttore di accensione/spengimento, occorre scollegare il cavo (o i cavi) di alimentazione di questo apparecchio dalla presa di corrente. La presa di corrente deve essere situata presso l'apparecchio e facilmente accessibile.

Aviso! Certifique-se que a fonte principal de energia elétrica está desconectada antes de instalar os módulos OG-12G-AM no bastidor ou antes de instalar e remover opções. Se o interruptor principal não existir, o cabo elétrico deste equipamento proporciona o meio de desconexão. A tomada elétrica deverá ser instalada perto do equipamento e deverá ser de fácil acesso.

¡Advertencia! Asegúrese que la red de alimentación está desconectada antes de instalar los módulos OG-12G-AM en el marco, o la instalación y extracción de opciones. Si no se proporciona un conmutador de red, el cable de alimentación de este equipo proporciona los medios de desconexión. El zócalo tomacorriente debe estar instalado cerca del equipo y debe ser fácilmente accesible.



Warning! Dual Power Cord Notice—please read this. To reduce the risk of electrical shock, disconnect both power cords before servicing equipment.

Avertissement ! Avis concernant la double alimentation électrique—à lire soigneusement. Pour éviter tout risque d'électrocution, débranchez les deux câbles électriques avant d'intervenir sur l'équipement.

Achtung! Hinweis auf Doppel-Netzkabel-bitte lesen. Um das Risiko eines Elektroschocks zu verringern, müssen beide Netzkabel ausgestöpselt werden, bevor die Vorrichtung gewartet wird.

Avvertenza. Avviso concernente il cavo di alimentazione doppio - leggere attentamente. Per ridurre il rischio di elettrocuzione, scollegare entrambi i cavi di alimentazione prima di eseguire la manutenzione o riparazioni di questo apparecchio.

Aviso! Aviso de Cabo Elétrico Duplo - por favor, leia isto. Para reduzir o risco de choque elétrico, desconecte ambos os cabos elétricos antes de fazer manutenção ao equipamento.

¡Advertencia! Aviso del doble cable de alimentación - leer esto por favor. Para reducir el riesgo de descarga eléctrica, desconecte ambos cables de alimentación antes de dar servicio al equipo.



Caution! The OG-X-FR front fan door is heavy. Remove with Caution.

Attention! La porte du ventilateur avant OG-X-FR est lourde. Retirer avec précaution.

Achtung! Die OG-X-FR -Frontlüfter Tür ist schwer. Bitte vorsichtig entfernen.

¡Precaución! La puerta del ventilador frontal OG-X-FR es pesado. Extraer con precaución.

Atenção! A porta do ventilador frontal OG-X-FR é pesado. Remova com cuidado.

Attenzione! La porta ventola anteriore OG-X-FR è pesante. Rimuovere con cautela.



Warning! Do not open the chassis. There are no user-serviceable parts inside. Opening the chassis will void the warranty unless performed by an AJA service center or licensed facility.

Avertissement! Ne pas ouvrir le châssis. Aucun élément à l'intérieur du châssis ne peut être réparé par l'utilisateur. La garantie sera annulée si le châssis est ouvert par toute autre personne qu'un technicien d'un centre de service ou d'un établissement agréé AJA.

Warnung! Öffnen Sie das Gehäuse nicht. Keine der Geräteteile können vom Benutzer gewartet werden. Durch das Öffnen des Gehäuses wird die Garantie hinfällig, es sei denn, solche Wartungsarbeiten werden in einem AJA-Service-Center oder einem lizenzierten Betrieb vorgenommen.

¡Advertencia! No abra el chasis. El interior no contiene piezas reparables por el usuario. El abrir el chasis anulará la garantía a menos que se lo haga en un centro de servicio AJA o en un local autorizado.

Advertência! Não abra o chassi. Não há internamente nenhuma peça que permita manutenção pelo usuário. Abrir o chassi anula a garantia, a menos que a abertura seja realizada por uma central de serviços da AJA ou por um local autorizado.

Avvertenza! Non aprire lo chassis. All'interno non ci sono parti riparabili dall'utente. L'apertura dello chassis invaliderà la garanzia se non viene effettuata da un centro ufficiale o autorizzato AJA.



Caution! To meet safety regulations for leakage current, connect the dual power supplies to separate branch circuits.

¡Advertencia! Para cumplir con las normas de seguridad para la corriente de fuga, conecte las dos fuentes de alimentación para circuitos derivados diferentes.

Attention! Pour répondre aux mesures de sécurité concernant le courant de fuite, raccorder les sources d'alimentation doubles à des circuits de dérivation distincts.

Warnung! Zur Erfüllung der Sicherheitsbestimmungen bezüglich Reststrom schließen Sie bitte die zwei Netzteile an unterschiedlichen Abzwegleitungen an.

Cuidado! Para atender aos regulamentos de segurança para correntes de fuga, conecte as fontes duplas a circuitos elétricos separados.

Attenzione! Per soddisfare le norme di sicurezza sulla corrente di perdita, collegare i doppi alimentatori a circuiti derivati separati.

5 Year Warranty and Liability Information

Limited Warranty on Hardware

AJA Video Systems, Inc. (AJA Video) warrants that the hardware product, not including software components, will be free from defects in materials and workmanship for a period of five years from the date of purchase. AJA Video provides a separate software warranty as part of the license agreement applicable to software components.

If the Customer brings a valid claim under this limited warranty for a hardware product (hereafter, a “product”) during the applicable warranty period, AJA Video will, at its sole option and as the Customer’s sole remedy for breach of the above warranty, provide one of the following remedies:

- Repair or facilitate the repair the product within a reasonable period of time, free of charge for parts and labor.
- Replace the product with a direct replacement or with a product that performs substantially the same function as the original product.
- Issue a refund of the original purchase price less depreciation to be determined based on the age of the product at the time remedy is sought under this limited warranty.

To obtain service under this warranty, the Customer must notify AJA Video of the defect before expiration of the warranty period and make suitable arrangements for the performance of service by contacting AJA Video support through the channels set forth on the support contacts web page at <https://www.aja.com/support>.

Except as stated, the Customer shall bear all shipping, packing, insurance and other costs, excluding parts and labor, to effectuate repair. Customer shall pack and ship the defective product to a service center designated by AJA Video, with shipping charges prepaid. AJA Video shall pay to return the product to Customer, but only if to a location within the country in which the AJA Video service center is located. SOME JURISDICTIONS DO NOT ALLOW THE EXCLUSION OF IMPLIED WARRANTIES OR LIMITATIONS ON APPLICABLE STATUTORY RIGHTS OF A CONSUMER, SO SOME OR ALL OF THE TERMS OF THIS PARAGRAPH MAY NOT APPLY TO YOU.

Limitation of Liability

Under no circumstances shall AJA video BE LIABLE IN ANY WAY FOR ANY LOST, CORRUPTED OR DESTROYED DATA, FOOTAGE OR WORK, OR FOR ANY OTHER INDIRECT, SPECIAL, INCIDENTAL OR CONSEQUENTIAL DAMAGES OR LOST PROFITS, OR FOR ANY THIRD PARTY CLAIM, IN CONNECTION WITH THE PRODUCT, WHETHER RESULTING FROM DEFECTS IN THE PRODUCT, SOFTWARE OR HARDWARE FAILURE, OR ANY OTHER CAUSE WHATSOEVER, EVEN IF AJA VIDEO HAS BEEN ADVISED OF THE POSSIBILITY OF SUCH DAMAGES. AJA VIDEO’S LIABILITY IN CONNECTION WITH THE PRODUCT SHALL UNDER NO CIRCUMSTANCES EXCEED THE PURCHASE PRICE PAID FOR THE PRODUCT. The foregoing limitations apply even if any remedy set forth in this LIMITED WARRANTY fails of its essential purpose. SOME JURISDICTIONS DO NOT ALLOW THE LIMITATION OF LIABILITY FOR PERSONAL INJURY, OR OF INCIDENTAL OR CONSEQUENTIAL DAMAGES, SO SOME OR ALL OF THE TERMS OF THIS PARAGRAPH MAY NOT APPLY TO YOU.

Governing Law and Language; Your Rights

This limited warranty is the only warranty provided by AJA Video on the hardware product. It supersedes all prior or contemporaneous understandings regarding such subject matter. No amendment to or modification of this warranty will be binding unless in writing and signed by AJA Video. The laws of the State of California, USA will govern this warranty and any dispute arising from it. Any translation of this Agreement is intended for convenience and to meet local requirements and in the event of a dispute between the English and any non-English versions, the English version of this warranty will govern. This limited warranty gives you specific legal rights and you may have other rights that vary from jurisdiction to jurisdiction, some of which are noted above.

Index

Symbols

3G-SDI Level B 16

A

AJA Support 2
Audio SRC Tab Screen 18
Audio X-Point Tab Screen 17

C

Card Information Screen 14
Configuration Settings
 Stored in OG cards 12

D

DashBoard Control System 7
 Control Interface Basic
 Components 13
 Documentation 12
 Downloading 12
 Rebooting 21
 Requirements 12
 Uploading New Software 19
 Using 12
Default Settings 12
Diagram
 Simplified Block 5
DIP Switches 12
Direction 17

F

Features 4

H

HANC Data: 16

I

Identify Card 19
Input Tab Screen 16
Installation 8
 Cabling 11

L

LED Indicators 5

O

OG Card Installation 9
openGear and AJA 8
Output Tab Screen 16

P

Packet Processing Control 16
Parameter Controls 15

R

Rear Plate Installation 8

S

Sample Rate Converter 18
Selection Status 17
Setup Tab Screen 19
Signal Generator 16
Signal Indicators
 DashBoard Control System 6
SRC Settings
 Description 18
Status Information Screen 15

U

User Controls 7

V

Video Channel Pair 17
Video Signal Generator 16