

OG-4K2HD

4K/UltraHD-SDI to 3G-SDI Down-Converter

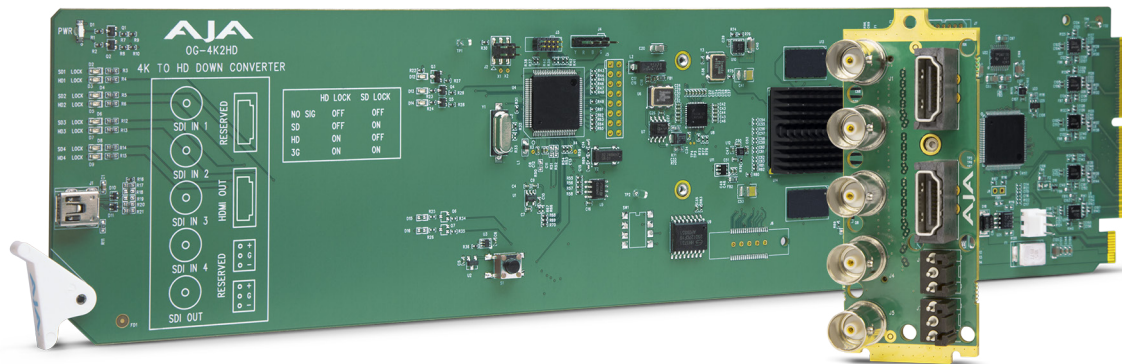

Installation and Operation Guide

Version 1.5.2
Published April 8, 2022



Notices

Trademarks

AJA® and Because it matters.® are registered trademarks of AJA Video Systems, Inc. for use with most AJA products. AJA™ is a trademark of AJA Video Systems, Inc. for use with recorder, router, software and camera products. Because it matters.™ is a trademark of AJA Video Systems, Inc. for use with camera products.

Corvid Ultra®, Io®, Ki Pro®, KONA®, KUMO®, ROI® and T-Tap® are registered trademarks of AJA Video Systems, Inc.

AJA Control Room™, KiStor™, Science of the Beautiful™, TruScale™, V2Analog™ and V2Digital™ are trademarks of AJA Video Systems, Inc.

All other trademarks are the property of their respective owners.

Copyright

Copyright © 2022 AJA Video Systems, Inc. All rights reserved. All information in this manual is subject to change without notice. No part of the document may be reproduced or transmitted in any form, or by any means, electronic or mechanical, including photocopying or recording, without the express written permission of AJA Video Systems, Inc.

Contacting AJA Support

When calling for support, have all information at hand prior to calling. To contact AJA for sales or support, use any of the following methods:

Telephone	+1.530.271.3190
FAX	+1.530.271.3140
Web	https://www.aja.com
Support Email	support@aja.com
Sales Email	sales@aja.com

Contents

Notices	2
Trademarks	2
Copyright	2
Contacting AJA Support	2
Chapter 1 – Introduction	5
Overview	5
OG-4K2HD Operating Modes	5
Default Operation	6
Video Output	6
DashBoard Control	7
Features	7
Block Diagram	8
openGear and AJA	8
I/O Connections	9
Signal Indicators on the OG-4K2HD Card	9
Signal Indicators in the DashBoard Control System	10
User Controls	11
DashBoard Control System	11
Installation	12
Summary	12
Unpacking	12
Rear OG-4K2HD Card Installation	12
Front OG-4K2HD Card Installation	13
Cabling	14
Chapter 2 – Operation	15
Using the DashBoard Control System	15
Requirements	15
Control Interface Basic Components	15
Card Tab Screen	17
Status Tab Screen	18
Input Tab Screen	19
Video Source	19
Color Space	19
RGB Range	20
Bit Depth	20
Mapping	20
3G-B Mode	20
Output Tab Screen	21
4K Convert	21
2K Crop	21
Edge Filtering	22
Passthrough	22
3G-B Mode	22
Progressive to Interlace	22
HDMI Tab Screen	23
Color Space	23
Bit Depth	23
RGB Range	23
Color Dithering	24
HDMI/DVI	24
HDR Metadata Screen	24
Output Overrides	25
Custom HDMI Metadata	26
Audio Tab Screen	27
HDMI Channel Count	27
Audio Input Source	27

Audio Offset In Frames	27
Setup Tab Screen.	28
Card Name	28
Identify Card	28
Factory Settings.	29
Upload Screen	29
Rebooting	31
Appendix A – Specifications	32
OG-4K2HD Tech Specs	32
Appendix B – Safety and Compliance	38
Warranty and Liability Information	47
Limited Warranty on Hardware.	47
Limitation of Liability	47
Governing Law and Language; Your Rights.	47
Index.	49

Chapter 1 – Introduction

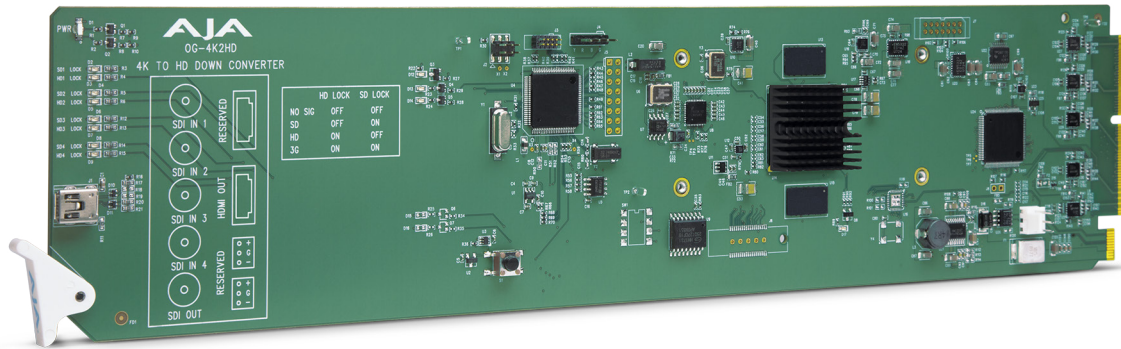

Overview

AJA's OG-4K2HD is an openGear card that down-converts professional SDI 4K/ UltraHD signals to HD resolution using AJA's high quality scaling for cost effective monitoring and conversion. OG-4K2HD's HD-SDI and HDMI outputs are both live all the time, producing fantastic looking HD images for on set monitoring or direct-to-air broadcast. The OG-4K2HD supports automatic or configurable HDR metadata generation for the SDI output VPID and HDMI output HDR Infoframe.

OG-4K2HD supports high frame rate (HFR) 4K inputs at 50 and 60fps and converts them to HD outputs at 50 and 60fps for accurate viewing. OG-4K2HD's configuration options can extract an HD resolution image from the 4K input to provide a one-to-one pixel image for 4K focus checks on HD displays.

Designed for use in high-density openGear 2RU frames including AJA's OG-3-FR 2RU frame, new DashBoard Software support on Windows®, macOS® and Linux® offers remote control and monitoring of the openGear architecture and provides convenient and industry-standard configuration, monitoring and control options over a PC or local network.

OG-4K2HD Operating Modes

OG-4K2HD has three working modes: 4K Down-Conversion mode, Non-4K mode, and Center Cut mode. The first two modes are selected automatically depending on the input video. These modes can also be manually set using the DashBoard application.

- **4K Down Conversion mode:** If the format of the input video is detected as 4K or UltraHD format, or the unit is configured by DashBoard, 4K/UltraHD input video is down-scaled to 2K/HD video and then output on both the HDMI and the SDI outputs.
- **Non-4K mode:** If the format of input video is detected as non-4K video, e.g. 720p60, or the unit is configured by DashBoard, the OG-4K2HD will route that non-4K video from the selected SDI input to the OG-4K2HD's HDMI/SDI outputs.
- **Center Cut mode:** OG-4K2HD will be in Center Cut mode if the input video is 4K/UltraHD format, and the mode has been enabled through DashBoard. In this mode the 2K/HD center of 4K/UltraHD input video will be output to the HDMI and SDI outputs. No down-scaling occurs, and the output format

is either 1920x1080 or 2048x1080 (depending the input source and the 2K cropping configuration).

Default Operation

The OG-4K2HD auto configures to the connected inputs.

The auto-configure function identifies the connected inputs and generates the default outputs for the given input. Default operation can be overridden and set manually using AJA's DashBoard application.

NOTE: Signal conversion requires the presence of a valid SDI video signal on the SDI IN 1 BNC.

For single SD or HD inputs, BNC input 1 is the default input. For dual-link 1.5Gb HD inputs, and 4K/UltraHD dual-stream 3Gb SDI inputs, inputs 1 and 2 are default. Where applicable, both level A and B 3Gb inputs are auto-detected and supported.

When connecting the OG-4K2HD with multiple SDI inputs in the auto-configure mode (default), as the user connects the first HD-SDI to input 1, the unit will output that input as full screen HD. As soon as the second input is connected, the unit will detect that either UltraHD or 4K x 2160 is present. At that time, if the input video is Square Division (Quadrant) the display will change to show the two connected quadrants in the upper left and upper right of the output and the remaining two quadrants will be displayed as they are connected. 2SI video input to the OG-4K2HD will be displayed as full screen images on output regardless of the number of connections made.

The OG-4K2HD supports low frame rate 4K/UltraHD inputs with either 4x1.5G links or 2x3G Level B-DS links. For the two link case, SDI1 and SDI2 are assumed to be the inputs. For Square Division (Quadrant) inputs, SDI1 linkA makes the top left quadrant, SDI1 linkB makes the top right quadrant, SDI2 linkA makes the lower left quadrant, and SDI2 linkB makes the lower right quadrant. To use this mode change the Video Source Selection to '2 X SDI 4K'.

Video Output

OG-4K2HD has two output connectors, HDMI and SDI, that are both active simultaneously.

For 4096x2160 inputs, the OG-4K2HD will output 2048x1080 if 2K crop option is turned off (through DashBoard), otherwise 4096x2160 inputs will be scaled to 2048x1080, then cropped to 1920x1080. OG-4K2HD will not scale 4096 to 1920 pixels.

The HDMI and SDI output connectors will generally be the same video, with the exception of non-4K PsF video input.

SDI pass through is enabled by default if the input video is 2K/HD PsF. In this case, SDI output is PsF format, and HDMI output is progressive format. The HDMI output is delayed one frame, compared to the SDI output. The SDI pass through can be disabled by DashBoard. If disabled, the SDI output will be progressive format, the same as HDMI output, with no frame delay.

The HDMI and SDI outputs are turned off when no active SDI Input signal is detected, allowing connected displays to go on Standby/Sleep mode.

HDMI and SDI Output Control Differences

Some video output control options are only applicable to HDMI output, such as color range, sample structure or HDMI/DVI standard. Some options are only applicable to SDI output, such as Level B control, or PsF passthrough. And some output control options are applied to both, such as Center Cut.

DashBoard Control

Configuration set via DashBoard is stored in the OG-4K2HD unit through subsequent power cycles.

DashBoard Control Functions

Input Video Selections

- Video Source (Auto, 4xSDI 4K, 2xSDI 4K, 2xSDI HD-DL, SDI 1-4)
- Color Space (Auto, 422 YCbCr, 444 RGB, or 444 YCbCr)
- RGB Range (SMPTE or Full color range).
- Bit Depth (Auto, 8-bit, or 10-bit)
- Pixel Mapping (Quadrant or 2SI)
- Video Format (Auto, Progressive, Interlaced, or PsF).
- 3G-B Mode (Auto, Dual Link, 2xHD, 1 x HD DS1, 1 x HD DS2)

Output Video Selections

- 4K Convert (Downconvert, Center Cut)
- 2K Crop (On or Off)
- SDI Out (Passthrough or Processed)
- Edge Filtering (On or Off)
- 1080p to 1080i interlacer

HDMI Output

- Color Space (Auto, 4:2:2 YCbCr, 4:4:4 RGB, 4:4:4 YCbCr)
- Bit Depth (Auto, 8-bit, or 10-bit)
- RGB Range (Auto, SMPTE or Full)
- Color Dithering (Off or On)
- HDMI/DVI (Auto, HDMI, or DVI)

Audio

- Input Source (Ch 1-8 or Ch 9-16 from any SDI input)
- HDMI Channel Count (Auto, 2, 8)
- Audio Offset In Frames

Features

- 4K (4096x2160) and UltraHD (3840x2160) support (see ["Appendix A Specifications" on page 24](#) for a complete list of supported inputs)
- Down-conversion for supporting 4K on HD-SDI and HDMI devices
- Center cut of original 4K frame supported for focus checks
- Simultaneous HD-SDI and HDMI outputs
- SDI and HDMI outputs support HDR
- HDR signaling metadata pass-through and optional override
- Supports 4K/UltraHD 50/60fps high frame rate input formats
- openGear compatible card
- Controlled by DashBoard network control software
- Requires Two Slots in openGear Frame
- Rear I/O Card Included

- Use with openGear 2RU frames including AJA's OG-3-FR frame
- Five year warranty

NOTE: 3D is not supported in this converter.

NOTE: 720p 4:4:4 formats are not supported in this release.

Block Diagram

Figure 1. OG-4K2HD, Simplified Block Diagram

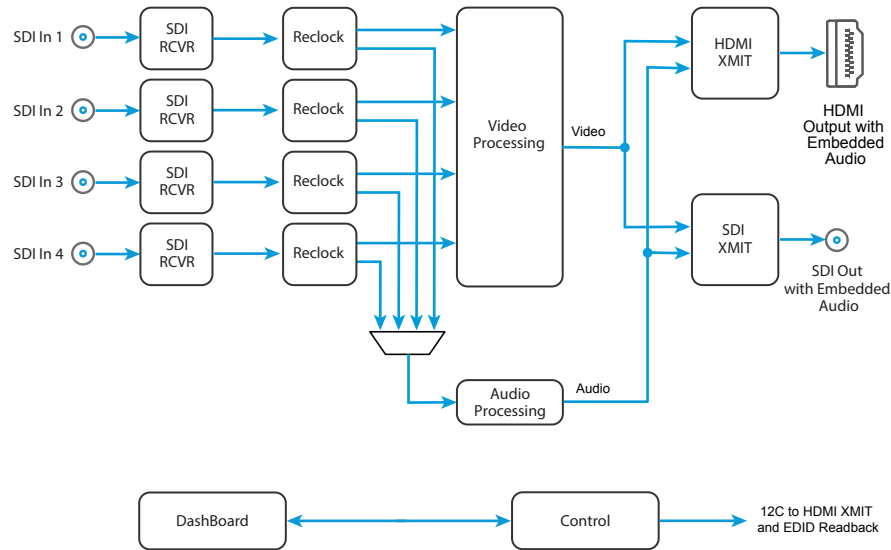

openGear and AJA

openGear is an open-architecture, modular frame system designed by Ross Video and supported by a diverse range of terminal equipment manufacturers, including AJA. Ross Video manufactures the frames, power supplies and network cards for openGear. AJA is a reseller of the openGear frames.

AJA Video is a leading manufacturer of video interface technologies, converters, digital video recording solutions and professional cameras, bringing high-quality, cost-effective products to the professional, broadcast and post-production markets. AJA products, including openGear cards, are designed and manufactured at our facilities in Grass Valley, California.

I/O Connections

Figure 2. I/O Connections for the OG-4K2HD

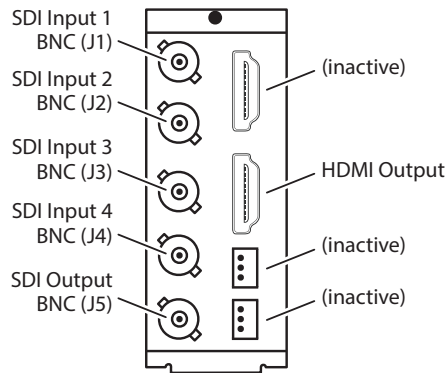

Signal Indicators on the OG-4K2HD Card

Located at the upper front area of the OG-4K2HD card, the SD Lock and HD Lock LEDs work in combination to indicate the type of signal detected for each SDI input.

Figure 3. LED lights on card

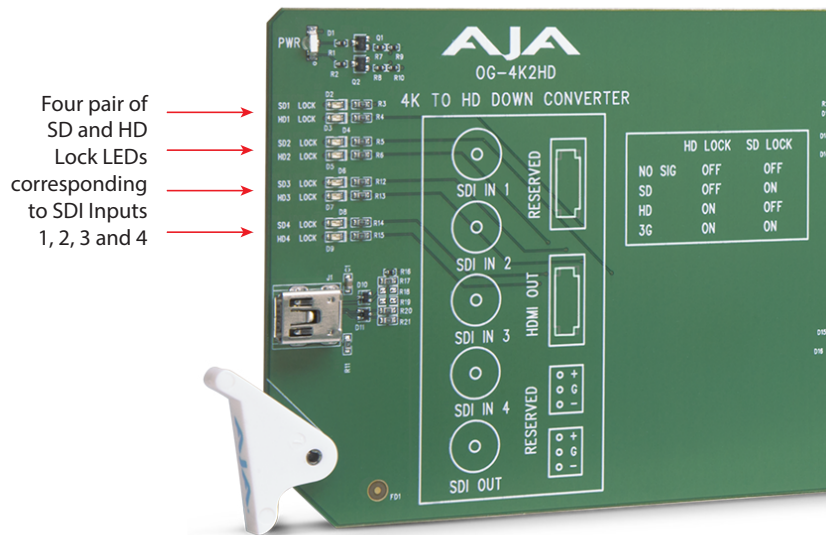

Table 1. The meaning of the behaviors of the lights for each pair of SD and HD Lock LEDs.

Signal Detected	HD Lock Light	SD Lock Light
No Signal	Off	Off
SD Signal	Off	On
HD Signal	On	Off
3G Signal	On	On

Signal Indicators in the DashBoard Control System

When the signal is either not present or is not locked, the DashBoard Control System shows a yellow Card State alarm under the Status tab. Additionally, the Signal State is shown as "No Input."

Figure 4. Signal not present or not locked

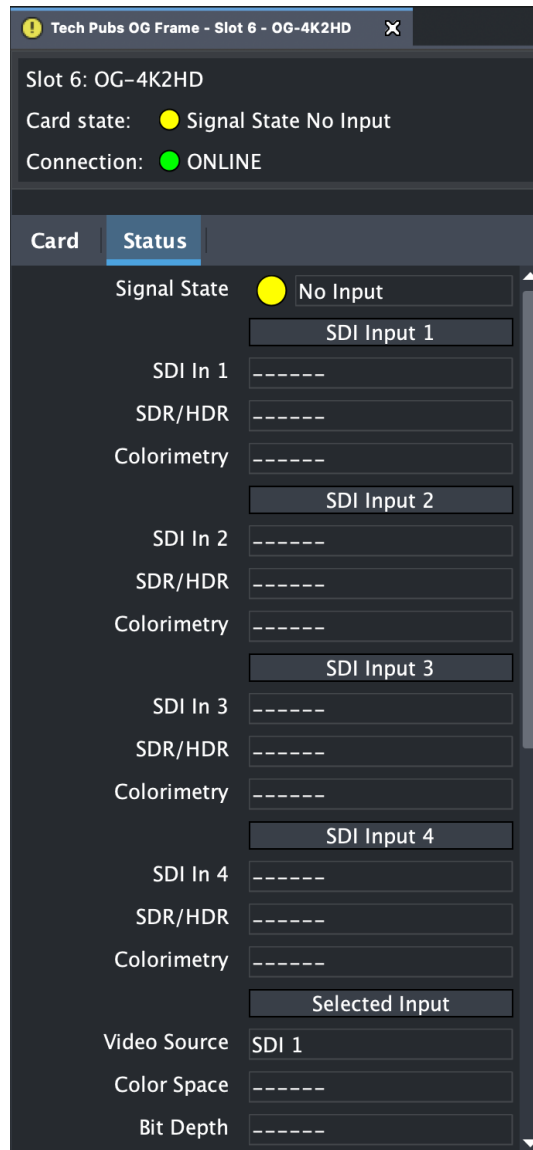

When a signal is present and locked, the DashBoard Control System shows a green Card State and a green Connection under the Status tab. The SDI Signal is also indicated (for example, "1920x1080p29.97 Quad").

Figure 5. Signal is present and locked

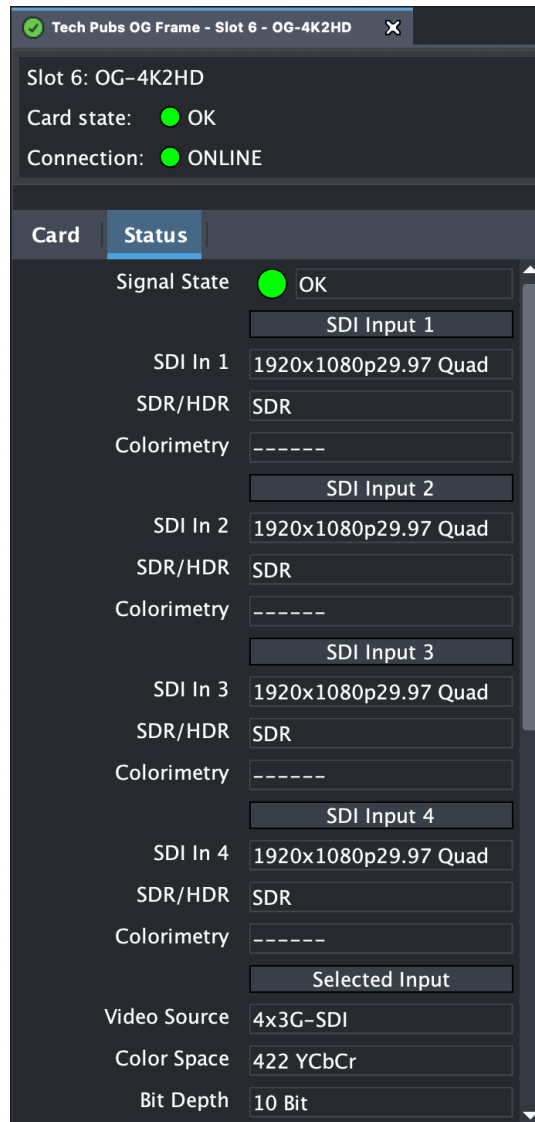

User Controls

The OG-4K2HD can be used right out of the box for many applications, since it is designed to recognize inputs and perform standard actions automatically. However, you can also manually configure the OG-4K2HD using remote configuration through the DashBoard Control System for an openGear Frame.

DashBoard Control System

The DashBoard Control System, created by Ross Video, provides a control interface between Windows, macOS and Linux computers and the cards installed in an openGear frame. DashBoard operates through TCP/IP communication and requires an Ethernet connection between the controlling computer and an openGear frame.

For details about acquiring and using the DashBoard Control System, refer to ["Using the DashBoard Control System" on page 15.](#)

Installation

Summary

Installing an OG-4K2HD card into an OGX or OG3 openGear frame consists of the following steps:

- Install the Rear Panel onto the back of the frame corresponding to the slot pair you will be using for the OG-4K2HD card.
- Insert the OG-4K2HD card into the frame in the right (even numbered) slot of the pair.
- Connect the BNC, HDMI and audio cabling to the Rear Panel.



ESD Susceptibility - Static discharge can cause serious damage to sensitive semiconductor devices. Avoid handling circuit boards in high static environments such as carpeted areas, and when wearing synthetic fiber clothing. Always exercise proper grounding precautions when working on circuit boards and related equipment.

Unpacking

Unpack each openGear product you received from the shipping container and ensure that all items are included. If any items are missing or damaged, contact your sales representative or AJA directly.

Parts List

<i>Quantity</i>	<i>Description</i>
1	OG-4K2HD Front Card in ESD bag
1	BNC Rear Card

Rear OG-4K2HD Card Installation

1. Ensure that the frame is properly installed.
2. Locate the card frame slot on the rear of the openGear frame into which you wish to install the openGear card.

NOTE: An OG-4K2HD card occupies two slots in the frame.

3. Using a Phillips screwdriver, unscrew the top screw from the desired blank rear plate and remove the rear plate.
4. Seat the bottom of the Rear Card in the seating slot at the base of the frame back plane.

Figure 6. Rear Card Inserting Into Frame Seating Slot

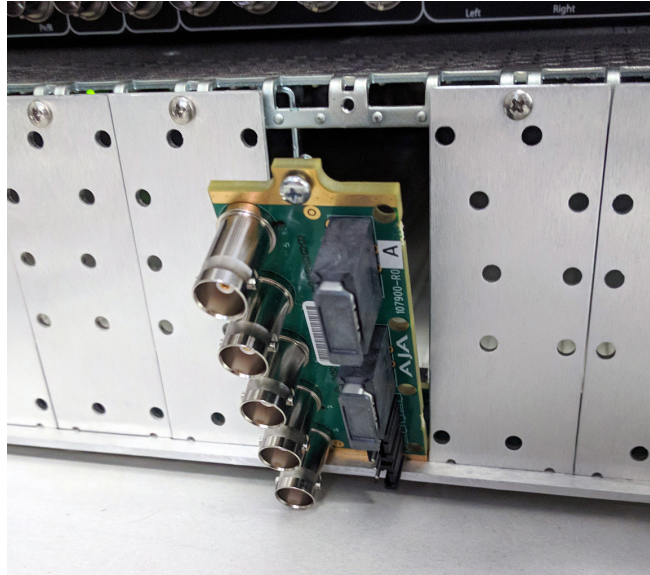

5. Align the top screw of the Rear Card with the screw hole on the top edge of the frame back plane.
6. Ensure the Rear Card aligns with the desired card slot before tightening the screw.
7. Using a Phillips screwdriver, fasten the Rear Card to the frame back plane. Do not over tighten.

Figure 7. Rear Card Inserted Into Frame Seating Slot

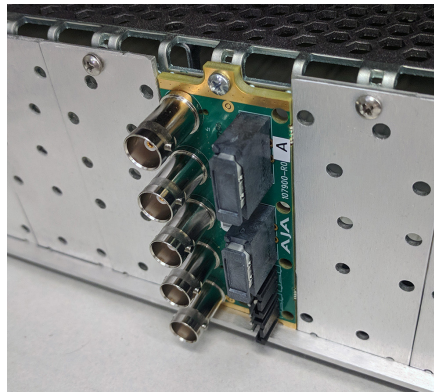

8. Ensure proper frame cooling and ventilation by having all rear frame slots covered with rear modules or blank metal plates if plates are not pre-installed.

Front OG-4K2HD Card Installation

1. Open the openGear frame door as follows:
 - A. Gently pull the side door tabs towards the center of the door, releasing the door from the frame.
 - B. Using both hands, pull the door towards you. The door extender arms prevent the door from falling.
2. Locate the Rear Card you installed as described above. The interior slot number is dependent on the slot combinations into which you installed the Rear Card. This allows adequate spacing to avoid damaging the card, the cards installed in the neighboring slots, or both.

3. Hold the card by the edges and carefully align the card edges with the rails inside the frame. The slots are numbered starting from the left-most slot when facing the frame front.

IMPORTANT: OG-4K2HD cards are installed into the right (even numbered) slot of the pair in order to connect with the rear panel.

4. Fully insert the card into the frame until the card is properly seated in the Rear Card.

Figure 8. OG-4K2HD card inserted Into Right Slot

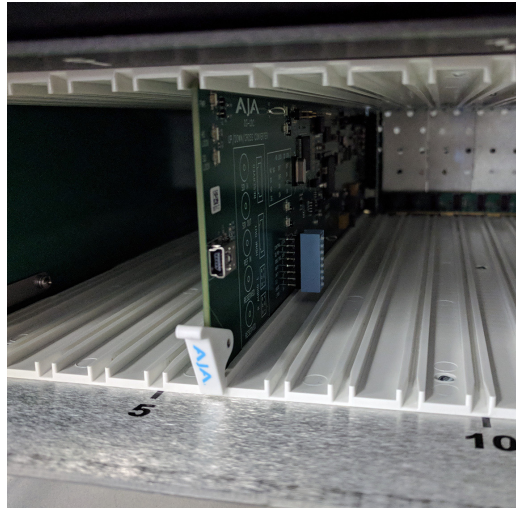

5. Close the frame door as follows:
 - A. Slide the door into the frame.
 - B. Pull and release the door tabs to ensure the frame door is securely locked to the frame.

Cabling

Refer to ["I/O Connections for the OG-4K2HD" on page 9](#) to identify the input and output signal connectors.

Chapter 2 – Operation

Using the DashBoard Control System

The DashBoard Control System is available as a free download from the openGear DashBoard Software Download webpage:

<https://www.opengear.tv/frame-and-control/control-system/download/>

Ross Video offers comprehensive documentation that covers the extensive capabilities of the DashBoard Control System:

<https://www.rossvideo.com/support/product-documentation/dashboard/>

This AJA OG-4K2HD manual addresses only those essential aspects of the DashBoard Control System needed to control the OG-4K2HD card.

Requirements

The DashBoard Control System requires the following components:

- openGear frame with a Frame Controller card
- Ethernet connection between the controlling computer and the openGear frame

NOTE: The openGear frame ships from AJA with the MFC-8322-S Frame Controller card for controlling the new AJA DashBoard cards. The openGear frame also supports the MFC-0G3-N Advanced Networking Frame Controller card, which can be used to control compatible OG cards.

DashBoard automatically discovers openGear and DashBoard Connect devices, such as openGear frames and cards that are present and accessible on your network.

Control Interface Basic Components

The basic components of the DashBoard Control System user interface consist of the basic tree view of frames and cards, the card information and status panel, and the parameter controls panel. These elements are shown below in Figure 6.

The basic tree view of frames and cards shows the frames and cards that are discoverable by DashBoard on your network.

The card information and status panel, shown in the middle panel, display the basic status of the card currently selected in DashBoard.

The parameter controls panel shows the tabs and parameters that the selected card has available for configuration and control.

Figure 9. Main Sections of the DashBoard User Interface

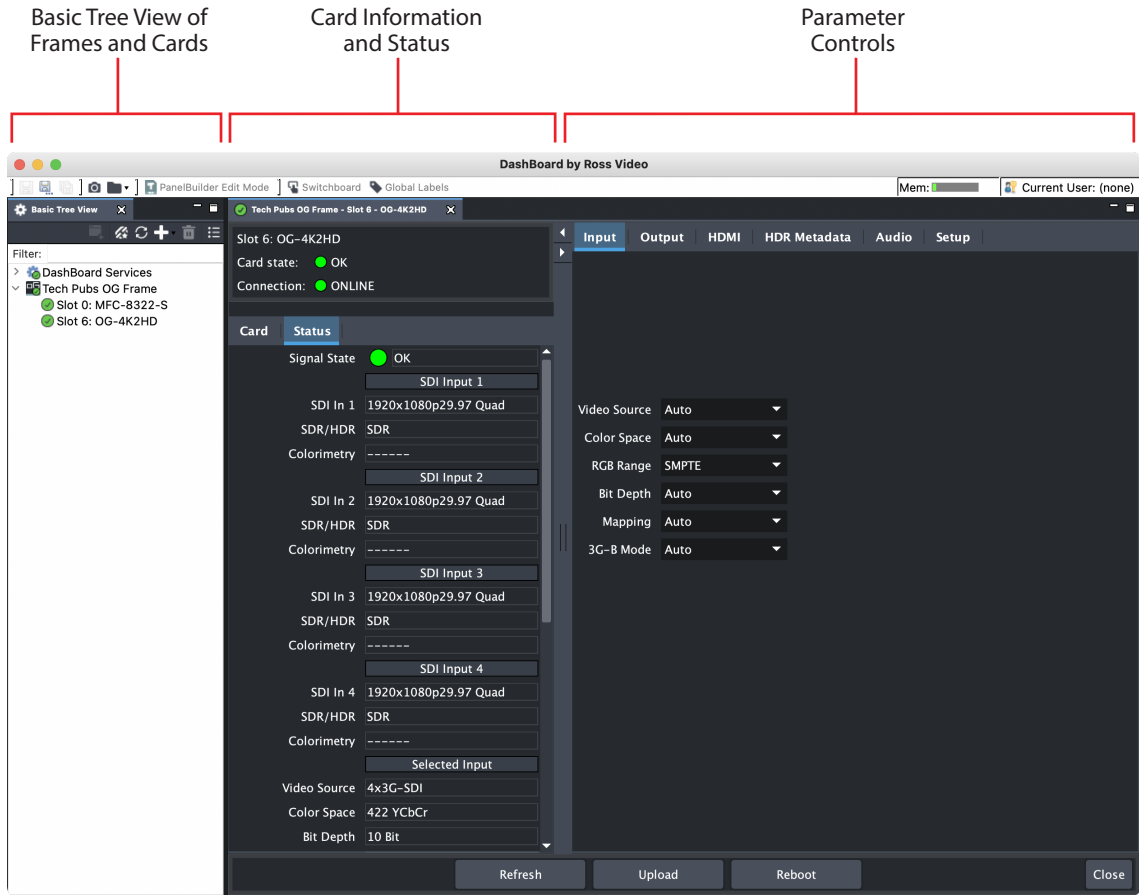

Card Tab Screen

Figure 10. OG-4K2HD Card Tab Screen in Dashboard

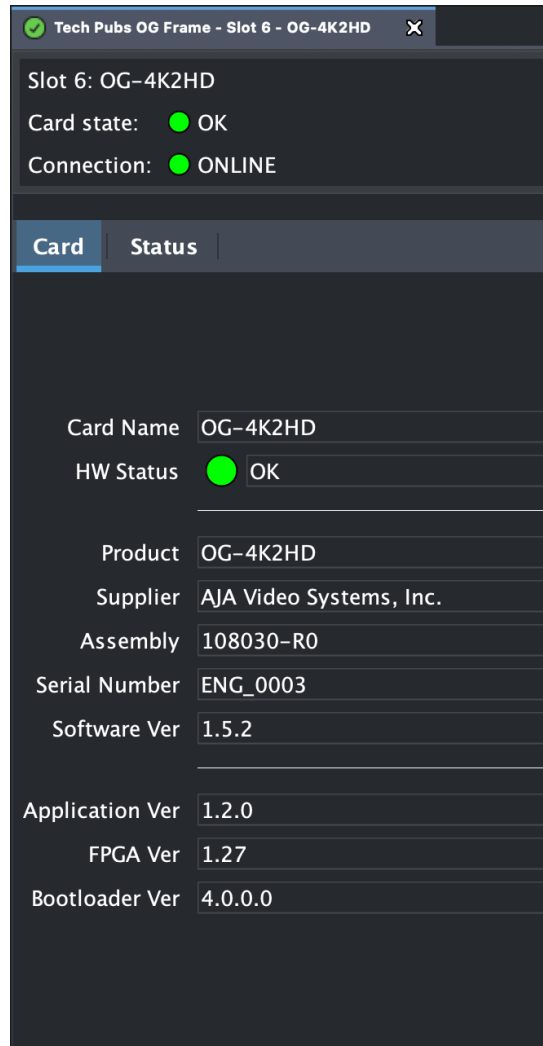

The Card tab screen indicates the basic information about the card itself such as the card name, hardware status, serial number, software version and other items.

Status Tab Screen

Figure 11. OG-4K2HD Status Tab Screen in DashBoard

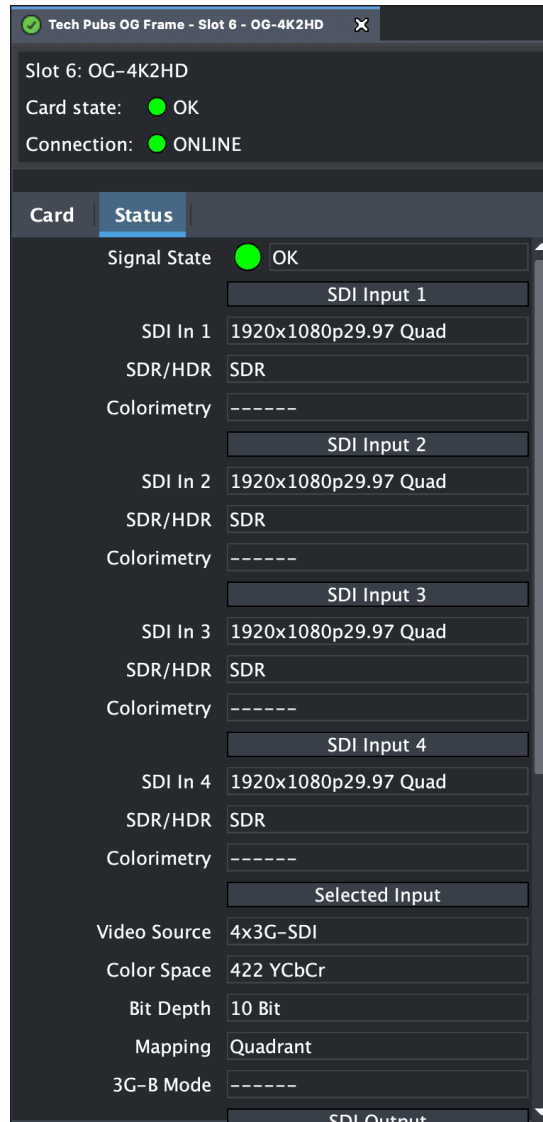

The SDI In 1 - 4 status controls report whether the signal is connected, or **No Input**.

Each SDI Input reports the signal detected by the card's corresponding inputs.

Input Tab Screen

Figure 12. OG-4K2HD Input Tab Screen in Dashboard

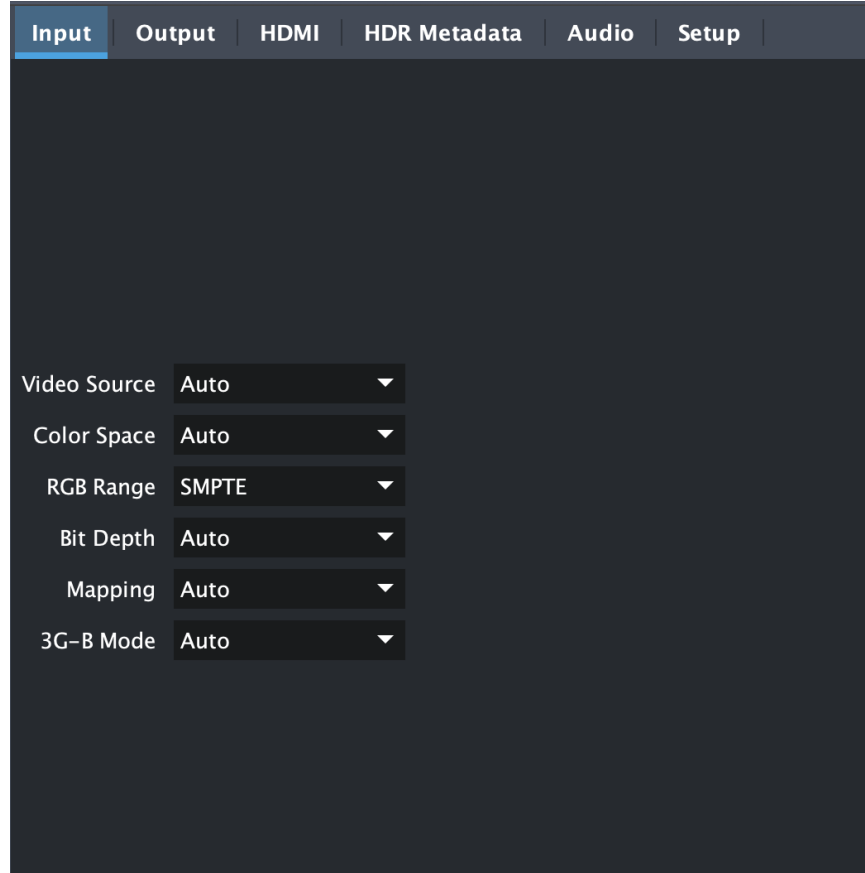

Click on the Input tab to view and make changes to the converter's input settings.

Video Source

Selects the input video format. Choose from the following:

- Auto - automatically selects the format based on the input video parameters.
- 4x3G-SDI
- 2x3G-SDI - (3G-B Dual Stream input required)
- 2x1.5G-SDI - (2 wire SMPTE 372)
- SDI 1, SDI 2, SDI 3, or SDI 4

NOTE: *One of the 4 incoming quadrants of 4K video can be shown full screen on the HDMI/SDI outputs. This is accomplished by selecting one of the 4 SDI inputs, but requires that all 4 SDI inputs are connected.*

Color Space

Selects the Input Video Color Space. Choose Auto, 422 YCbCr, 444 RGB, or 444 YCbCr. Choosing "Auto" will automatically select color mode based on the input video parameters and the payload ID.

RGB Range

Selects the Input Video Color Range. Choose SMPTE (default) or Full color range. There is no auto detection for color range. Applies only to RGB input formats. Does not apply to YCbCr formats.

Bit Depth

Selects the input video bit depth. Choose Auto, 8-bit or 10-bit. Choosing "Auto" automatically selects the bit depth based on the input video parameters and the payload ID.

Mapping

Select the 4K/UltraHD pixel mapping format. This only applies when using 4x3G or 2x3G inputs.

Auto (default) -automatically selects the mapping based on the input video.

2SI - Two Sample Interleave

Quadrant - Square Division

3G-B Mode

Selects the 3G level B Video Mode. Choose from the following:

Auto - automatically selects the format based on the input video parameters.

Level B DL - select this when the input is Dual Link.

Level B DS - Dual Stream - each Data Stream is an independent source.

Level B DS Link 1 - use only Data Stream 1 as a single video.

Level B DS Link 2 - use only Data Stream 2 as a single video.

Output Tab Screen

Figure 13. OG-4K2HD Output Tab Screen in DashBoard

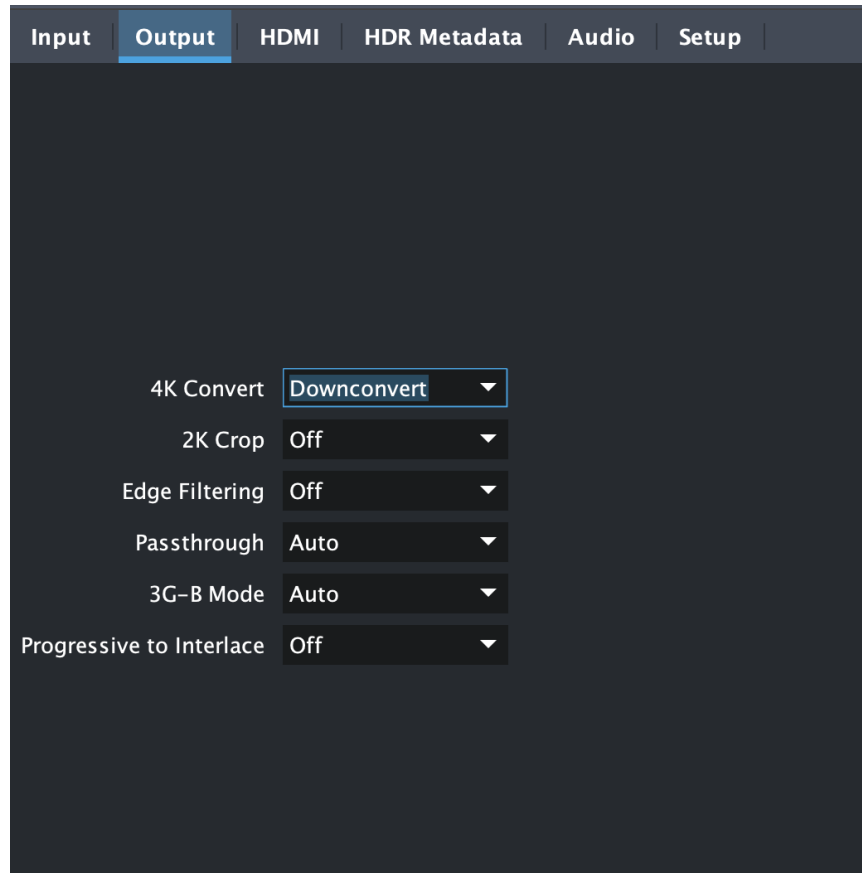

Click on the Output tab to view and make changes to the OG-4K2HD Output settings. These settings can affect both the HDMI and SDI outputs.

The HDMI and SDI outputs are turned off when no active SDI Input signal is detected, allowing connected displays to go on Standby/Sleep mode.

4K Convert

Downconvert - Downconverts incoming 4K signal to 2K, and UltraHD to HD (1080p) (default setting).

Center Cut - Selects the center portion of the incoming 4K/UltraHD signal for display. No down-scaling occurs, and the output format is either 1920x1080 or 2048x1080, depending on the input source and the 2K Crop setting.

2K Crop

Choose On or Off. Provides the option of center cutting 2Kx1080 video signals to make 1920x1080, or center cutting a 4Kx2160 signal to make 1920x1080. Default is On.

Edge Filtering

Choose On or Off. You can disable edge filtering with this control. This is useful if you are stitching together multiple images of OG-4K2HD outputs. An example is using four OG-4K2HDs to view UltraHD-2 or 8K on a UltraHD/4K or HD monitor. Each OG-4K2HD downconverts one quarter of the 8K image. Disabling edge filtering can eliminate the center vertical and horizontal lines that would occur between the quadrants in that situation. Default setting is On.

Passthrough

This setting can be used with HD or 2K PsF format input signals.

Choose Auto, Off, or On. Auto default is On. When On, the unit outputs PsF when the input is PsF. When Off, the unit outputs progressive when the input is PsF.

3G-B Mode

Choose Auto (default), 3G-A, or 3G-B.

Progressive to Interlace

Choose Off or On. When On, a 4K/UltraHD progressive input will be output as a 1920x1080 interlace signal when possible.

More specifically, when Progressive to Interlace is enabled, the OG-4K2HD converts 4096x2160 or 3840x2160 progressive signals to a 1920x1080 interlace signal. Crop is automatically applied if the input signal is 4K.

This conversion is functional for the 4K and UltraHD input formats listed below:

Input	Output
3840x2160p25 3840x2160p50 4096x2160p25 4096x2160p50	1920x1080i25
3840x2160p29.97 3840x2160p59.94 4096x2160p29.97 4096x2160p59.94	1920x1080i29.97
3840x2160p30 3840x2160p60 4096x2160p30 4096x2160p60	1920x1080i30

HDMI Tab Screen

Figure 14. OG-4K2HD HDMI Tab Screen in DashBoard

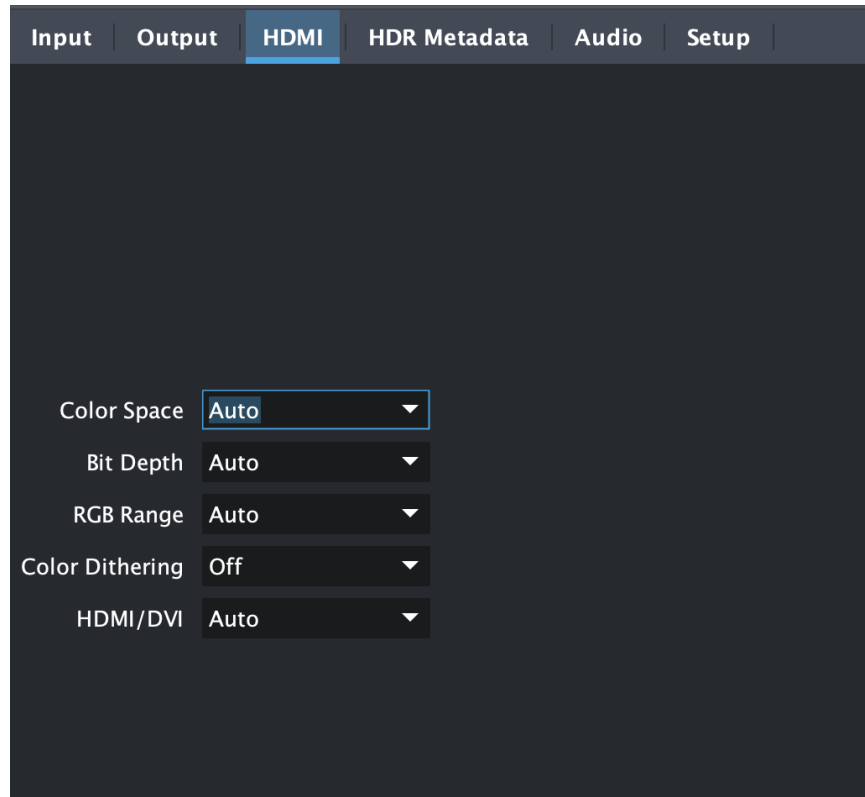

Click on the HDMI tab to view and make changes to the OG-4K2HD HDMI output settings.

Color Space

Selects the desired output video format. Choose from the following:

Auto - selects the video format based on the input video and the attached device's capabilities (default setting).

4:2:2 YCbCr - (cannot exceed 10-bit depth)

4:4:4 RGB

4:4:4 YCbCr

Bit Depth

Choose from Auto, 8-bit, or 10-bit (see limitations above). Choosing "Auto" automatically selects the bit depth based on the input video and the attached device's capabilities.

RGB Range

Choose Auto, SMPTE or Full. Choosing "Auto" automatically selects the same value as the input range setting. Applies only to RGB output formats. It does not apply to YCbCr output formats.

Color Dithering

Choose Off or On. Default is Off.

HDMI/DVI

Choose Auto, HDMI, or DVI. When DVI is selected, any audio signals present are not passed. Choosing "Auto" automatically selects the output mode based on the attached device's capabilities. Default is Auto.

HDR Metadata Screen

Figure 15. OG-4K2HD HDR Metadata Screen in DashBoard

The screenshot displays the HDR Metadata configuration interface. At the top, there are navigation tabs: Input, Output, HDMI, HDR Metadata (selected), Audio, and Setup. The main content area is divided into several sections:

- Output Overrides:** Contains three dropdown menus: SDR/HDR (set to Auto), Colorimetry (set to Auto), and HDMI Metadata (set to Auto).
- Custom HDMI Metadata:** Includes a Presets section with buttons for BT.709, BT.2020, and DCI-P3. Below this are input fields for color and white point values:
 - Red x[2]: 0.68000
 - Red y[2]: 0.32000
 - Green x[0]: 0.26500
 - Green y[0]: 0.69000
 - Blue x[1]: 0.15000
 - Blue y[1]: 0.06000
 - White Point x: 0.32120
 - White Point y: 0.32900
- Factory Settings:** A button labeled "Factory Settings" is located below the custom metadata fields.
- Display Mastering:** Includes input fields for:
 - Display Mastering Lum Min: 0.0005
 - Display Mastering Lum Max: 1000
 - Max CLL: 1000
 - Max FALL: 400

Click on the HDR Metadata tab to view and, if necessary, make changes to the OG-4K2HD High Dynamic Range metadata. For SDI, this metadata defines the VPID (Video Payload Identifier) for Transfer Characteristic and Colorimetry. For HDMI, it defines the EOTF and Colorimetry and sets parameters for the Dynamic Range and Mastering infoframes. The HDR metadata is a mechanism to inform an HDMI sink device (such as a TV or monitor) that the video content is HDR encoded.

NOTE: HDR Metadata values do not modify video image data. They define the HDR metadata included in the video output.

For most workflows the Auto settings for the Output Overrides parameters are appropriate, which will automatically pass incoming HDR metadata, if present, through to the output. However, this metadata may need to be edited for a specific workflow, or to correct inaccurate incoming metadata.

Output Overrides

The override controls on the right can be used to replace incoming or missing HDR metadata with alternative values for the OG-4K2HD's HDMI and SDI outputs.

SDR/HDR

This setting controls what SDR/HDR metadata value is applied to the video output.

- Auto - Passes the SDR/HDR value from the video input to the output.
- SDR - An SDR value is applied to the output.
- PQ - A PQ value is applied to the output.
- HLG - An HLG value is applied to the output.

Colorimetry

This setting controls what Colorimetry metadata value is applied to the video output.

- Auto - Passes the Colorimetry value from the video input to the output.
 - BT.601, BT.709 and BT.2020 values are passed through.
 - If a non-supported colorimetry value is received, then BT.601 is signaled for SD formats and BT.709 is signaled for HD/UltraHD formats.
- BT.709 - A BT.709 value is applied to the output.
- BT.2020 - A BT.2020 value is applied to the output.

HDMI Metadata

This setting can be used to insert custom metadata values in the HDMI HDR Infoframe.

- Auto - The 8 RGB vertices/white point parameters that get inserted into the HDMI HDR Infoframe are automatically generated:
 - If the incoming Colorimetry value is BT.709, Color VANC Packet, or Unknown, then BT.709 values are passed to the outputs.
 - If the incoming Colorimetry value is BT.2020, BT.2020 values are passed to the outputs.
- Custom - The 8 RGB vertices/white point parameters defined on the left side of the screen are applied to the outputs.

NOTE: The four mastering parameters (Max CLL, etc) set in Dashboard are always inserted into the HDMI HDR Infoframe, although HDMI HDR Infoframes are only generated if the SDR/HDR value is PQ or HLG.

Custom HDMI Metadata

The twelve Custom HDMI Metadata parameters in the lower part of the HDR Metadata tab can be used to define HDR color, white point, and luminance values.

*NOTE: These settings are only applied when the HDMI Metadata parameter is set to **Custom**. These values can be changed at any time (even with **Auto** selected), in which case those values will only be applied after selecting **Custom**.*

Presets

For user convenience, the eight top values (RGB vertices and white point) can be preset to default **BT.709**, default **BT.2020** or default **DCI-P3** values.

Red, Green, Blue, White Point

These eight values define the color gamut and white point, and are adjustable in units of 0.00002 cd/m², with a range of 0.00000 to 1.00000 cd/m².

Presets – Factory Settings

Click **Factory Settings** to restore the DM Lum (min, max), Maximum CLL and Maximum FALL HDR Metadata settings to their factory default settings.

DM Lum

These two parameters define the Display Mastering Luminance.

- **Minimum:** Defines the floor of the SMPTE ST 2086 color volume (in the case of HDR) and is determined by the mastering environment.
 - Range: 0.00000 cd/m² to 1.00000 cd/m².
 - Step size: 0.00002 cd/m².
- **Maximum:** Defines the ceiling of the SMPTE ST 2086 color volume (in the case of HDR) and is determined by the mastering environment.
 - Range: 1 cd/m² to 65535 cd/m².
 - Step size: 1 cd/m².

Maximum: CLL

Represents the highest-value pixel component in an entire scene. It is determined by analyzing each frame of video, and can be determined in the post environment.

- Range: 1 cd/m² to 65535 cd/m².
- Step size: 1 cd/m².

Maximum: FALL

Represents the maximum of frame-based average light levels taken over an entire scene, and can be determined in the post environment.

- Range: 1 cd/m² to 65535 cd/m².
- Step size: 1 cd/m².

Audio Tab Screen

Figure 16. OG-4K2HD Audio Tab Screen in DashBoard

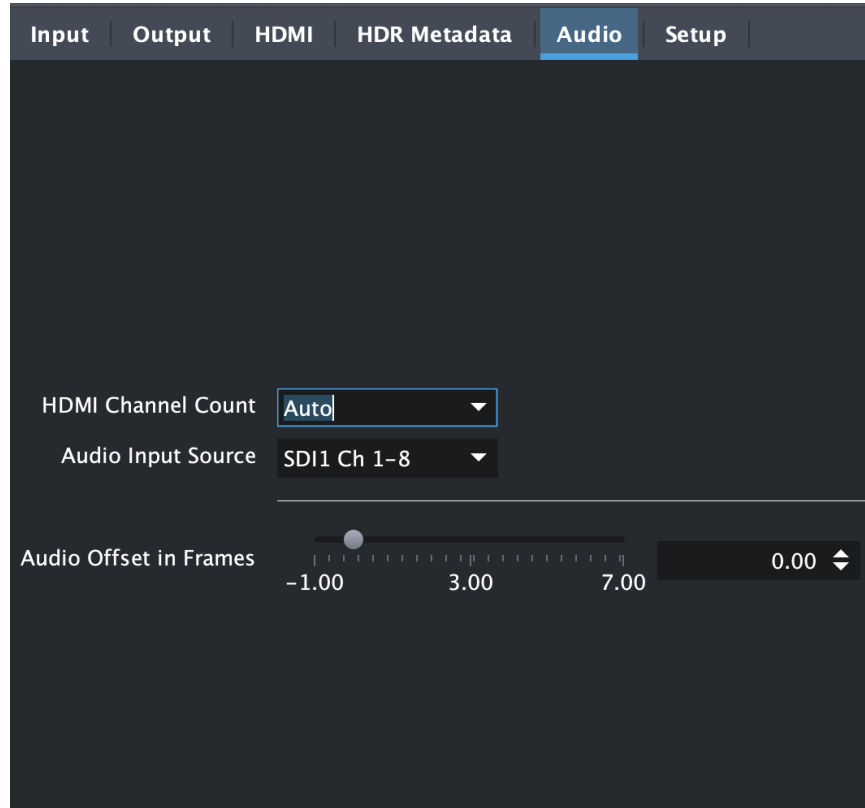

Click on the Audio tab to view and make changes to the OG-4K2HD audio settings.

HDMI Channel Count

Choose Auto, 2 of 8 channels or 8 channels embedded audio. Choosing “Auto” automatically selects the audio channels based on the attached device’s capabilities.

The SDI output embedded audio always follows the selected HDMI Output source selection and is limited to 8 channels max.

Audio Input Source

Choose which embedded audio channels are routed to the HDMI output. Eight channels are routed at a time. You can choose Ch 1-8 or Ch 9-16 from any SDI input.

Audio Offset In Frames

Permits time shifting the embedded audio in relationship to the video (for example, to correct for lip sync problems), in 1/16 of a frame increments. Range is from -0.8125 video frame to +7.0 video frames. The actual time duration of delay will vary depending on the frame rate of the format being converted.

Default offset value is 0 frame to match the video delay path, resulting in time-aligned audio on the output. Positive offset delays the audio additional frames (relative to the video output), negative offset advances the audio relative to the video output.

Setup Tab Screen

Click on the Setup tab to view and make changes to the card name or to restore card settings to factory default values.

Figure 17. OG-4K2HD Setup Tab Screen in DashBoard

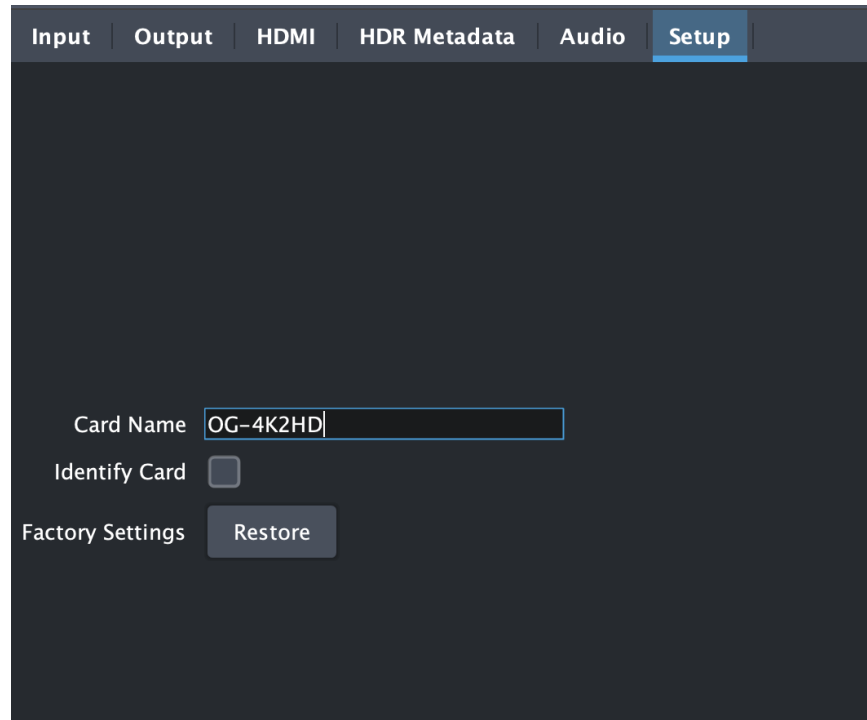

Card Name

By default, this field is pre-populated with the card name OG-4K2HD. You can change the card name by editing the text in the Card Name field. The card name controls the name of the card that appears in the DashBoard tree view.

Identify Card

Click the checkbox to turn on Identify Card. This is especially useful when working with numerous cards and frames and you need a simple method for identifying a specific card. Click the checkbox again to turn Identify Card off.

On - Turn on if you need to identify the card. When on, the PWR LED located at the front top edge of the card will blink on and off with an orange/green color.

Off - Turn off (default) if you do not need to physically identify the card. When Identify Card is off, the PWR LED light follows the state of the card as shown in the DashBoard tree view.

- Green Icon = Green LED
- Yellow icon = yellow power LED
- Red Icon = Red LED

Factory Settings

If you would like to revert the card settings to factory default values, click **Restore**. A confirmation window displays. Select **Yes** to restore to factory settings. Select **No** to cancel.

Upload Screen

To Upload New Software

1. Check the AJA website for new software for your OG-4K2HD. If new software is found, download it and uncompress the file archive (zip).
2. Click the Upload button in the lower panel of the DashBoard Control System to open the Upload Software Wizard.

Figure 18. OG-4K2HD Upload Software Wizard window in Dashboard

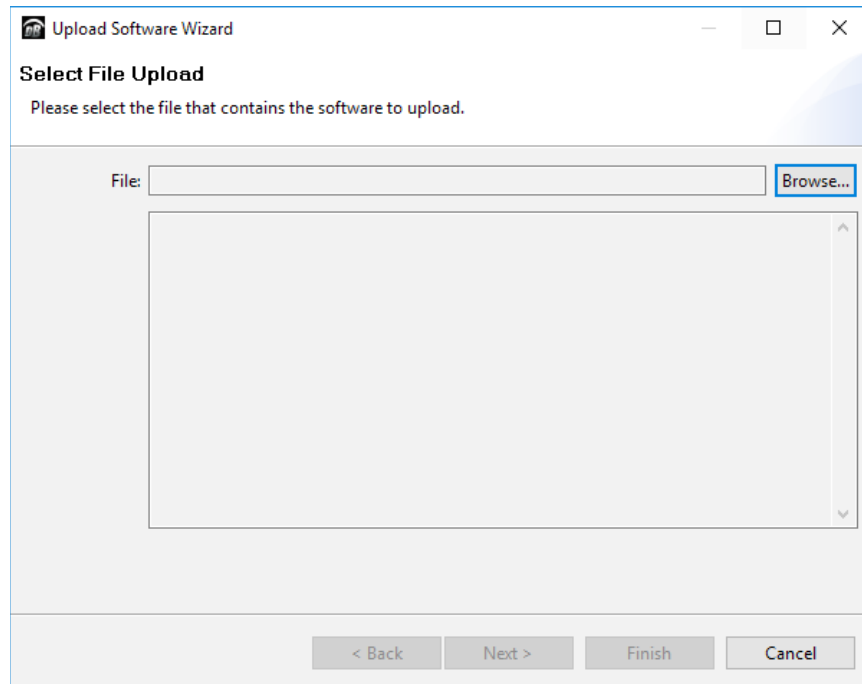

3. From the Upload Software Wizard window, select **Browse**.
4. Navigate to the location of the downloaded .bin file containing the software update. Select the .bin file, then select **Open**. The Upload Software Wizard window displays characteristics of the selected file for uploading.
5. Click **Finish**. The Uploading to Selected Devices window displays with a progress bar.

Figure 19. OG-4K2HD Uploading to Selected Devices window in Dashboard

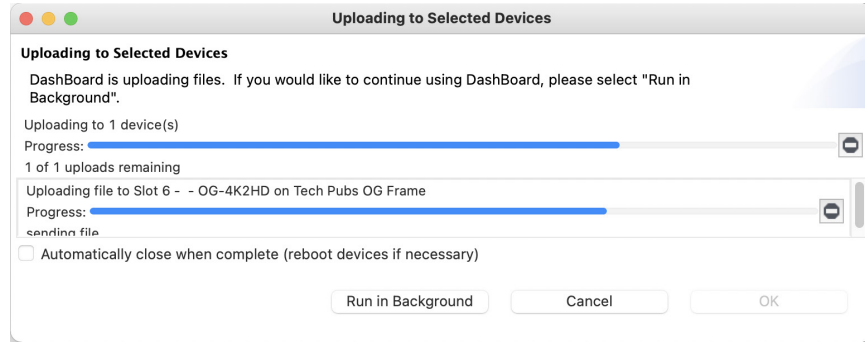

6. When the progress bar indicates that the uploading is finished and status indicates "Complete," click **OK**.
7. To verify the version of software or firmware currently installed on your card, select the Card tab from the center panel of Dashboard.

Figure 20. OG-4K2HD Card Tab Screen in Dashboard indicating the currently installed software version.

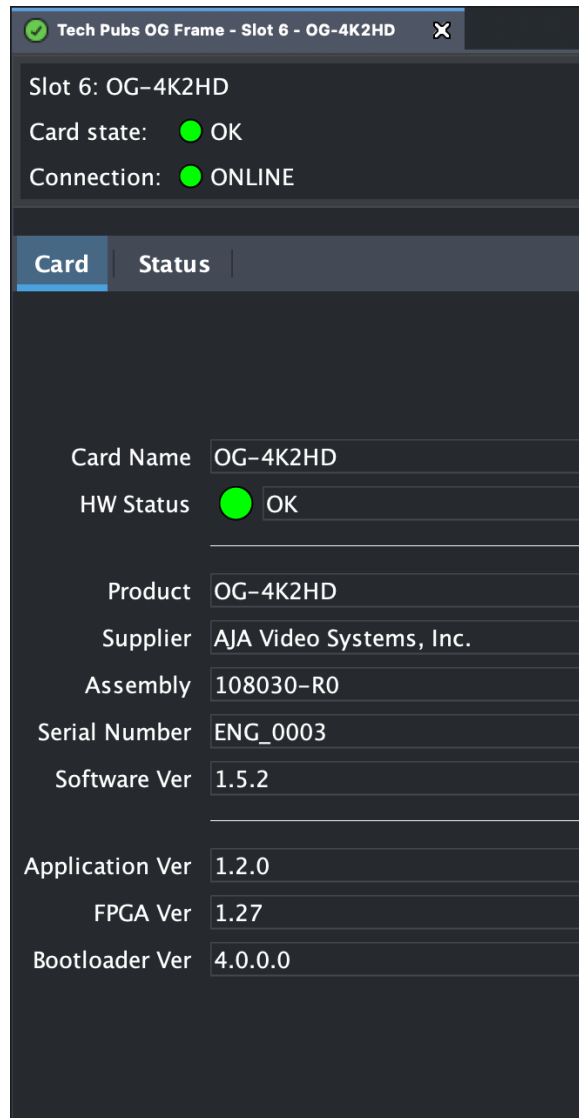

Rebooting

Rebooting is a standard function built in to the DashBoard Control System, and should only be performed if the board has become unresponsive.

WARNING: *During a reboot, any down-converting operations will be briefly interrupted, but will be restored once the reboot has completed.*

To Reboot the OG-4K2HD

1. Click the Reboot button in the lower panel of DashBoard. The reboot confirmation message displays.

Figure 21. Reboot confirmation window



2. Click **Yes**. The message "Loading data, please wait. Refreshing device data" displays for a moment. The card will be offline for a few seconds, and any current conversion operations will be interrupted.
3. Following a Reboot operation, the board configuration will return to the settings that were in place at the time of rebooting.

Appendix A – Specifications

OG-4K2HD Tech Specs

Video Formats

- (4K) 4096 x 2160p
- (4K) 4096 x 2160PsF
- (UltraHD) 3840 x 2160p
- (UltraHD) 3840 x 2160PsF
- (2K) 2048 x 1080p
- (2K) 2048 x 1080PsF
- (HD) 1920 x 1080p
- (HD) 1920 x 1080PsF
- (HD) 1920 x 1080i
- (HD) 1280 x 720p
- (SD) 720 x 576i
- (SD) 720 x 480i

NOTE: Raster and Frame Rate dependent, please see OG-4K2HD Video Formats in Documents and Manual.

Video Input Digital

- 4x 3G-SDI BNC, SMPTE-259/292/424
 - YCbCr 4:2:2/4:4:4
 - RGB 4:4:4, SMPTE or Full level
 - 10 or 12-bit
 - Two Sample Interleave (2SI) or Square Division (Quadrant) pixel mapping
- 4x 3 Gb SDI (Level A or B Dual Link)
 - (4K) 4096 x 2160p 23.98, 24, 25, 29.97, 30, 50, 59.94, 60
 - (4K) 4096 x 2160PsF* 23.98, 24, 25, 29.97, 30
 - (UltraHD) 3840 x 2160p 23.98, 24, 25, 29.97, 30, 50, 59.94, 60
 - (UltraHD) 3840 x 2160PsF* 23.98, 24, 25, 29.97, 30
- 4x 1.5 Gb SDI
 - (4K) 4096 x 2160p 23.98, 24, 25, 29.97, 30
 - (4K) 4096 x 2160PsF 23.98, 24, 25, 29.97, 30
 - (UltraHD) 3840 x 2160p 23.98, 24, 25, 29.97, 30
 - (UltraHD) 3840 x 2160PsF 23.98, 24, 25, 29.97, 30
- 2x 3 Gb SDI (Level B Dual Stream)
 - (4K) 4096 x 2160p 23.98, 24, 25, 29.97, 30
 - (4K) 4096 x 2160PsF 23.98, 24, 25, 29.97, 30
 - (UltraHD) 3840 x 2160p 23.98, 24, 25, 29.97, 30
 - (UltraHD) 3840 x 2160PsF 23.98, 24, 25, 29.97, 30
- 1x 3 Gb SDI (Level A or B Dual Link)
 - (2K) 2048 x 1080p 23.98, 24, 25, 29.97, 30, 50, 59.94, 60
 - (2K) 2048 x 1080PsF 23.98, 24, 25, 29.97, 30
 - (HD) 1920 x 1080p 23.98, 24, 25, 29.97, 30, 50, 59.94, 60
 - (HD) 1920 x 1080PsF 23.98, 24, 25, 29.97, 30

- (HD) 1920 x 1080i 50, 59.94, 60
- (HD) 1280 x 720p** 50, 59.94, 60
- 2x 1.5 Gb SDI (Dual Link HD-SDI), SMPTE-372
 - (2K) 2048 x 1080p 23.98, 24, 25, 29.97, 30, 50, 59.94, 60
 - (HD) 1920 x 1080p 23.98, 24, 25, 29.97, 30, 50, 59.94, 60
- 1x 1.5 Gb SDI
 - (2K) 2048 x 1080p 23.98, 24, 25, 29.97, 30
 - (2K) 2048 x 1080PsF 23.98, 24, 25, 29.97, 30
 - (HD) 1920 x 1080p 23.98, 24, 25, 29.97, 30
 - (HD) 1920 x 1080PsF 23.98, 24, 25, 29.97, 30
 - (HD) 1920 x 1080i 50, 59.94, 60
 - (HD) 1280 x 720p 50, 59.94, 60
- 1x 270 Mb SDI
 - (SD) 625i 50
 - (SD) 525i 59.94

*PsF is Level B Dual Link

**1280 x 720p is Level A Only

Video Output Digital

- 1x 3G-SDI BNC, SMPTE-259/292/424
 - Color space and sampling match input signal
 - HDR VPID pass-through or override for Colorimetry and Transfer Characteristic
- 1x 3 Gb SDI (Level A or B Dual Link)
 - (2K) 2048 x 1080p 23.98, 24, 25, 29.97, 30, 50, 59.94, 60
 - (2K) 2048 x 1080PsF 23.98, 24, 25, 29.97, 30
 - (HD) 1920 x 1080p 23.98, 24, 25, 29.97, 30, 50, 59.94, 60
 - (HD) 1920 x 1080PsF 23.98, 24, 25, 29.97, 30
 - (HD) 1920 x 1080i 50, 59.94, 60
 - (HD) 1280 x 720p* 50, 59.94, 60
- 1x 1.5 Gb SDI
 - (2K) 2048 x 1080p 23.98, 24, 25, 29.97, 30
 - (2K) 2048 x 1080PsF 23.98, 24, 25, 29.97, 30
 - (HD) 1920 x 1080p 23.98, 24, 25, 29.97, 30
 - (HD) 1920 x 1080PsF 23.98, 24, 25, 29.97, 30
 - (HD) 1920 x 1080i 50, 59.94, 60
 - (HD) 1280 x 720p 50, 59.94, 60
- 1x 270 Mb SDI
 - (SD) 625i 50
 - (SD) 525i 59.94
- 1x HDMI Type A connector, HDMI v1.4
 - YCbCr 4:2:2/4:4:4
 - RGB 4:4:4, SMPTE or Full level
 - 8 or 10-bit (4:4:4 limited to 8 bit)
 - HDR infocode generation with pass-through or override for Colorimetry and Transfer Characteristic
 - (2K) 2048 x 1080p 23.98, 24, 25, 29.97, 30, 50, 59.94, 60
 - (HD) 1920 x 1080p 23.98, 24, 25, 29.97, 30, 50, 59.94, 60
 - (HD) 1920 x 1080i 50, 59.94, 60
 - (HD) 1280 x 720p 50, 59.94, 60

- (SD) 720 x 576i 50
- (SD) 720 x 480i 59.94

*1280 x 720p is Level A Only

Audio Input Digital

- SDI embedded audio, 24-bit, 16-channel

Audio Output Digital

- SDI embedded audio, 24-bit, 8-channel
- HDMI embedded audio, 24-bit, 8-channel

User Interface

- openGear DashBoard network control software via Windows, macOS, or Linux

Size

- openGear standard form factor, front slot and rear card.
- Two slots required for each card.

Weight

- 0.5 lb (0.3 kg)

Power

- openGear frame compatible, 11.0 watts max per card

Environment

- Safe Operating Temperature: 0 to 40 C (32 to 104 F)
- Safe Storage Temperature (Power OFF): -40 to 60 C (-40 to 140 F)
- Operating Relative Humidity: 10-90% noncondensing
- Operating Altitude: <3,000 meters (<10,000 feet)

OG-4K2HD Video Formats

Video Input - 4K/UltraHD, HD, and SD, 4x BNC

4K/UltraHD Inputs Supported

4x 3G-SDI:

<i>Format</i>	<i>Frame Rate</i>	<i>Color Space</i>	<i>Sampling</i>	<i>Bit Depth</i>	<i>Level A/B</i>	<i>Pixel Mapping</i>
4096x2160p	50, 59.94, 60	YCbCr	4:2:2	10	A or B DL	SQD/2SI
4096x2160p	23.98, 24, 25, 29.97, 30	YCbCr/RGB	4:4:4	10, 12	A or B DL	SQD/2SI
4096x2160PsF	23.98, 24, 25, 29.97, 30	YCbCr/RGB	4:4:4	10, 12	A or B DL	SQD
3840x2160p	50, 59.94, 60	YCbCr	4:2:2	10	A or B DL	SQD/2SI
3840x2160p	23.98, 24, 25, 29.97, 30	YCbCr/RGB	4:4:4	10,12	A or B DL	SQD/2SI
3840x2160PsF	23.98, 24, 25, 29.97, 30	YCbCr/RGB	4:4:4	10, 12	A or B DL	SQD

2x 3G-SDI:

<i>Format</i>	<i>Frame Rate</i>	<i>Color Space</i>	<i>Sampling</i>	<i>Bit Depth</i>	<i>Level A/B</i>	<i>Pixel Mapping</i>
4096x2160p	23.98, 24, 25, 29.97, 30	YCbCr	4:2:2	10	B DS	SQD/2SI
4096x2160PsF	23.98, 24, 25, 29.97, 30	YCbCr	4:2:2	10	B DS	SQD
3840x2160p	23.98, 24, 25, 29.97, 30	YCbCr	4:2:2	10	B DS	SQD/2SI
3840x2160PsF	23.98, 24, 25, 29.97, 30	YCbCr	4:2:2	10	B DS	SQD

4x 1.5G-SDI:

<i>Format</i>	<i>Frame Rate</i>	<i>Color Space</i>	<i>Sampling</i>	<i>Bit Depth</i>
4096x2160p	23.98, 24, 25, 29.97, 30	YCbCr	4:2:2	10
4096x2160PsF	23.98, 24, 25, 29.97, 30	YCbCr	4:2:2	10
3840x2160p	23.98, 24, 25, 29.97, 30	YCbCr	4:2:2	10
3840x2160PsF	23.98, 24, 25, 29.97, 30	YCbCr	4:2:2	10

2K/HD Inputs Supported

1x 3G-SDI:

<i>Format</i>	<i>Frame Rate</i>	<i>Color Space</i>	<i>Sampling</i>	<i>Bit Depth</i>	<i>Level A/B</i>
2048x1080p	50, 59.94, 60	YCbCr	4:2:2	10	A or B DL
2048x1080p	23.98, 24, 25, 29.97, 30	YCbCr/RGB	4:4:4	10, 12	A or B DL
2048x1080PsF	23.98, 24, 25, 29.97, 30	YCbCr/RGB	4:4:4	10, 12	A or B DL
1920x1080p	50, 59.94, 60	YCbCr	4:2:2	10	A or B DL
1920x1080p	23.98, 24, 25, 29.97, 30	YCbCr/RGB	4:4:4	10, 12	A or B DL
1920x1080PsF	23.98, 24, 25, 29.97, 30	YCbCr/RGB	4:4:4	10, 12	A or B DL
1920x1080i	50, 59.94, 60	YCbCr/RGB	4:4:4	10, 12	A or B DL
1280x720p	50, 59.94, 60	YCbCr/RGB	4:4:4	10	A

2x 1.5G-SDI:

<i>Format</i>	<i>Frame Rate</i>	<i>Color Space</i>	<i>Sampling</i>	<i>Bit Depth</i>
2048x1080p	50, 59.94, 60	YCbCr	4:2:2	10
2048x1080p	23.98, 24, 25, 29.97, 30	YCbCr/RGB	4:4:4	10
1920x1080p	50, 59.94, 60	YCbCr	4:2:2	10
1920x1080p	23.98, 24, 25, 29.97, 30	YCbCr/RGB	4:4:4	10

1x 1.5G-SDI:

<i>Format</i>	<i>Frame Rate</i>	<i>Color Space</i>	<i>Sampling</i>	<i>Bit Depth</i>
2048x1080p	23.98, 24, 25, 29.97, 30	YCbCr	4:2:2	10
2048x1080PsF	23.98, 24, 25, 29.97, 30	YCbCr	4:2:2	10
1920x1080p	23.98, 24, 25, 29.97, 30	YCbCr	4:2:2	10
1920x1080PsF	23.98, 24, 25, 29.97, 30	YCbCr	4:2:2	10
1920x1080i	50, 59.94, 60	YCbCr	4:2:2	10
1280x720p	50, 59.94, 60	YCbCr	4:2:2	10

SD Inputs Supported

1x SD-SDI:

<i>Format</i>	<i>Frame Rate</i>	<i>Color Space</i>	<i>Sampling</i>	<i>Bit Depth</i>
625i	50	YCbCr	4:2:2	10
525i	59.94	YCbCr	4:2:2	10

SDI Video Output - HD and SD, 1x BNC

2K/HD Outputs Supported

1x 3G-SDI:

<i>Format</i>	<i>Frame Rate</i>	<i>Color Space</i>	<i>Sampling</i>	<i>Bit Depth</i>	<i>Level A/B</i>
2048x1080p	50, 59.94, 60	YCbCr	4:2:2	10	A or B DL
2048x1080p	23.98, 24, 25, 29.97, 30	YCbCr/RGB	4:4:4	10, 12	A or B DL
2048x1080PsF	23.98, 24, 25, 29.97, 30	YCbCr/RGB	4:4:4	10, 12	A or B DL
1920x1080p	50, 59.94, 60	YCbCr	4:2:2	10	A or B DL
1920x1080p	23.98, 24, 25, 29.97, 30	YCbCr/RGB	4:4:4	10, 12	A or B DL
1920x1080PsF	23.98, 24, 25, 29.97, 30	YCbCr/RGB	4:4:4	10, 12	A or B DL
1920x1080i	50, 59.94, 60	YCbCr/RGB	4:4:4	10, 12	A or B DL
1280x720p	50, 59.94, 60	YCbCr/RGB	4:4:4	10, 12	A

1x 1.5G-SDI:

<i>Format</i>	<i>Frame Rate</i>	<i>Color Space</i>	<i>Sampling</i>	<i>Bit Depth</i>
2048x1080p	23.98, 24, 25, 29.97, 30	YCbCr	4:2:2	10
2048x1080PsF	23.98, 24, 25, 29.97, 30	YCbCr	4:2:2	10
1920x1080p	23.98, 24, 25, 29.97, 30	YCbCr	4:2:2	10
1920x1080PsF	23.98, 24, 25, 29.97, 30	YCbCr	4:2:2	10
1920x1080i	50, 59.94, 60	YCbCr	4:2:2	10
1280x720p	50, 59.94, 60	YCbCr	4:2:2	10

SD Outputs Supported

1x SD-SDI:

<i>Format</i>	<i>Frame Rate</i>	<i>Color Space</i>	<i>Sampling</i>	<i>Bit Depth</i>
625i	50	YCbCr	4:2:2	10
525i	59.94	YCbCr	4:2:2	10

HDMI Video Output - HD and SD, 1x HDMI

2K/HD Outputs Supported

<i>Format</i>	<i>Frame Rate</i>	<i>Color Space</i>	<i>Sampling</i>	<i>Bit Depth</i>
2048x1080p	23.98, 24, 25, 29.97, 30, 50, 59.94, 60	YCbCr	4:2:2	8, 10
2048x1080p	23.98, 24, 25, 29.97, 30, 50, 59.94, 60	YCbCr/RGB	4:4:4	8, 10
1920x1080p	23.98, 24, 25, 29.97, 30, 50, 59.94, 60	YCbCr	4:2:2	8, 10
1920x1080p	23.98, 24, 25, 29.97, 30, 50, 59.94, 60	YCbCr/RGB	4:4:4	8, 10
1920x1080i	50, 59.94, 60	YCbCr	4:2:2	8, 10
1920x1080i	50, 59.94, 60	YCbCr/RGB	4:4:4	8, 10
1280x720p	50, 59.94, 60	YCbCr	4:2:2	8, 10
1280x720p	50, 59.94, 60	YCbCr/RGB	4:4:4	8, 10

SD Outputs Supported

<i>Format</i>	<i>Frame Rate</i>	<i>Color Space</i>	<i>Sampling</i>	<i>Bit Depth</i>
576i	50	YCbCr	4:2:2	8, 10
576i	50	YCbCr/RGB	4:4:4	8, 10
480i	59.94	YCbCr	4:2:2	8, 10
480i	59.94	YCbCr/RGB	4:4:4	8, 10

Appendix B – Safety and Compliance

Federal Communications Commission (FCC) Compliance Notices

Class A Interference Statement

This equipment has been tested and found to comply with the limits for a Class A digital device, pursuant to Part 15, Subpart B of the FCC Rules. These limits are designed to provide reasonable protection against harmful interference in a residential installation. This equipment generates, uses, and can radiate radio frequency energy and, if not installed and used in accordance with the instructions, may cause harmful interference to radio communications. However, there is no guarantee that interference will not occur in a particular installation. If this equipment does cause harmful interference to radio or television reception, which can be determined by turning the equipment off and on, the user is encouraged to try to correct the interference by one or more of the following measures:

- Reorient or relocate the receiving antenna.
- Increase the separation between the equipment and receiver.
- Connect the equipment into an outlet on a circuit different from that to which the receiver is connected.
- Consult the dealer or an experienced radio/TV technician for help.

FCC Caution

This device complies with Part 15 of the FCC Rules. Operation is subject to the following two conditions: (1) This device may not cause harmful interference, and (2) this device must accept any interference received, including interference that may cause undesired operation.

Canadian ICES Statement

Canadian Department of Communications Radio Interference Regulations

This digital apparatus does not exceed the Class A limits for radio-noise emissions from a digital apparatus as set out in the Radio Interference Regulations of the Canadian Department of Communications. This Class A digital apparatus complies with Canadian ICES-003.

Règlement sur le brouillage radioélectrique du ministère des Communications

Cet appareil numérique respecte les limites de bruits radioélectriques visant les appareils numériques de classe A prescrites dans le Règlement sur le brouillage radioélectrique du ministère des Communications du Canada. Cet appareil numérique de la Classe A est conforme à la norme NMB-003 du Canada.

European Union and European Free Trade Association (EFTA) Regulatory Compliance

This equipment may be operated in the countries that comprise the member countries of the European Union and the European Free Trade Association. These countries, listed in the following paragraph, are referred to as The European Community throughout this document:

AUSTRIA, BELGIUM, BULGARIA, CYPRUS, CZECH REPUBLIC, DENMARK, ESTONIA, FINLAND, FRANCE, GERMANY, GREECE, HUNGARY, IRELAND, ITALY, LATVIA, LITHUANIA, LUXEMBOURG, MALTA, NETHERLANDS, POLAND, PORTUGAL, ROMANIA, SLOVAKIA, SLOVENIA, SPAIN, SWEDEN, UNITED KINGDOM, ICELAND, LICHTENSTEIN, NORWAY, SWITZERLAND

Declaration of Conformity

Marking by this symbol indicates compliance with the Essential Requirements of the EMC Directive of the European Union 2014/30/EU.



This equipment meets the following conformance standards:

Safety

EN 62368-1: 2014 + A11 (T-Mark License),
IEC 62368-1: 2014 (CB Scheme Certificate)

Additional licenses issued for specific countries available on request.

Emissions

EN 55032: 2012 + AC: 2013, CISPR 32: 2015,
EN 61000-3-2: 2014, EN 61000-3-3: 2013

Immunity

EN 55103-2: 2009, EN 61000-4-2:2009, EN 61000-4-3: 2006 + A1:2008 + A2:2010,
EN 61000-4-4: 2004 + A1:2010, EN 61000-4-5:2006, EN 61000-4-6:2009,
EN 61000-4-11:2004

Environments: E2, E3 and E4

The product is also licensed for additional country specific standards as required for the International Marketplace.



Warning! This is a Class A product. In a domestic environment, this product may cause radio interference, in which case, the user may be required to take appropriate measures.

Achtung! Dieses ist ein Gerät der Funkstörgrenzwertklasse A. In Wohnbereichen können bei Betrieb dieses Gerätes Rundfunkstörungen auftreten, in welchen Fällen der Benutzer für entsprechende Gegenmaßnahmen verantwortlich ist.

Attention! Ceci est un produit de Classe A. Dans un environnement domestique, ce produit risque de créer des interférences radioélectriques, il appartiendra alors à l'utilisateur de prendre les mesures spécifiques appropriées..

Recycling Notice



This symbol on the product or its packaging indicates that this product must not be disposed of with your other household waste. Instead, it is your responsibility to dispose of your waste equipment by handing it over to a designated collection point for the recycling of waste electrical and electronic equipment. The separate collection and recycling of your waste equipment at the time of disposal will help conserve natural resources and ensure that it is recycled in a manner that protects human health and the environment. For more information about where you can drop off your waste for recycling, please contact your local authority, or where you purchased your product.

Korea KCC Compliance Statement

사용자 안내문

이 기기는 업무용 환경에서 사용할 목적으로 적합성평가를 받은 기기로서 가정용 환경에서 사용하는 경우 전파간섭의 우려가 있습니다.

Taiwan Compliance Statement

警告使用者：
這是甲類的資訊產品，在居住的環境中使用時，可能會造成射頻干擾，在這種情況下，使用者會被要求採取某些適當的對策。

This is a Class A product based on the standard of the Bureau of Standards, Metrology and Inspection (BSMI) CNS 13438, Class A. In a domestic environment this product may cause radio interference in which case the user may be required to take adequate measures.

Japan Compliance Statement

この装置は、クラスA情報技術装置です。この装置を家庭環境で使用すると電波妨害を引き起こすことがあります。この場合には使用者が適切な対策を講ずるよう要求されることがあります。 VCCI-A

This is a Class A product based on the standard of the VCCI Council (VCCI 32: 2016). If this equipment is used in a domestic environment, radio interference may occur, in which case, the user may be required to take corrective actions.

Translated Warning and Caution Messages

The following caution statements, warning conventions, and warning messages apply to this product and manual.



Warning Symbol



Hazard Symbol



Caution Symbol

Before Operation Please Read These Instructions



Warning! Read and follow all warning notices and instructions marked on the product or included in the documentation.

Avertissement! Lisez et conformez-vous à tous les avis et instructions d'avertissement indiqués sur le produit ou dans la documentation.

Warnung! Lesen und befolgen Sie die Warnhinweise und Anweisungen, die auf dem Produkt angebracht oder in der Dokumentation enthalten sind.

¡Advertencia! Lea y siga todas las instrucciones y advertencias marcadas en el producto o incluidas en la documentación.

Aviso! Leia e siga todos os avisos e instruções assinalados no produto ou incluídos na documentação.

Avviso! Leggere e seguire tutti gli avvisi e le istruzioni presenti sul prodotto o inclusi nella documentazione.



Warning! Do not use this device near water and clean only with a dry cloth.

Avertissement! N'utilisez pas cet appareil près de l'eau et nettoyez-le seulement avec un tissu sec.

Warnung! Das Gerät nicht in der Nähe von Wasser verwenden und nur mit einem trockenen Tuch säubern.

¡Advertencia! No utilice este dispositivo cerca del agua y límpielo solamente con un paño seco.

Aviso! Não utilize este dispositivo perto da água e limpe-o somente com um pano seco.

Avviso! Non utilizzare questo dispositivo vicino all'acqua e pulirlo soltanto con un panno asciutto.



Warning! Do not block any ventilation openings. Install in accordance with the manufacturer's instructions.

Avertissement! Ne bloquez aucune ouverture de ventilation. Suivez les instructions du fabricant lors de l'installation.

Warnung! Die Lüftungsöffnungen dürfen nicht blockiert werden. Nur gemäß den Anweisungen des Herstellers installieren.

¡Advertencia! No bloquee ninguna de las aberturas de la ventilación. Instale de acuerdo con las instrucciones del fabricante.

Aviso! Não obstrua nenhuma das aberturas de ventilação. Instale de acordo com as instruções do fabricante.

Avviso! Non ostruire le aperture di ventilazione. Installare in conformità con le istruzioni del fornitore.



Warning! Do not install near any heat sources such as radiators, heat registers, stoves, or other apparatus (including amplifiers) that produce heat.

Avertissement! N'installez pas l'appareil près d'une source de chaleur telle que des radiateurs, des bouches d'air de chauffage, des fourneaux ou d'autres appareils (amplificateurs compris) qui produisent de la chaleur.

Warnung! Nicht in der Nähe von Wärmequellen wie Heizkörpern, Heizregistern, Öfen oder anderen Wärme erzeugenden Geräten (einschließlich Verstärkern) aufstellen.

¡Advertencia! No instale cerca de fuentes de calor tales como radiadores, registros de calor, estufas u otros aparatos (incluidos amplificadores) que generan calor.

Aviso! Não instale perto de nenhuma fonte de calor tal como radiadores, saídas de calor, fogões ou outros aparelhos (incluindo amplificadores) que produzam calor.

Avviso! Non installare vicino a fonti di calore come termosifoni, diffusori di aria calda, stufe o altri apparecchi (amplificatori compresi) che emettono calore



Warning! Do not defeat the safety purpose of the polarized or grounding-type plug. A polarized plug has two blades with one wider than the other. A grounding type plug has two blades and a third grounding prong. The wide blade or the third prong are provided for your safety. If the provided plug does not fit into your outlet, consult an electrician for replacement of the obsolete outlet.

Avertissement! La sécurité de la prise polarisée ou de la prise de type mise à la terre ne doit en aucun cas être empêchée de fonctionner. Une prise polarisée a deux broches, l'une étant plus large que l'autre. Une prise de type mise à la terre a deux broches et une troisième broche pour la mise à la terre. La broche large ou la troisième broche sont fournies pour votre sécurité. Si la prise fournie ne s'insère pas dans votre prise femelle, consultez un électricien pour le remplacement de la prise femelle obsolète.

Warnung! Der Sicherheitszweck des gepolten bzw. Schukosteckers ist zu berücksichtigen. Ein gepolter Stecker verfügt über zwei Pole, von denen einer breiter als der andere ist. Ein Schukostecker verfügt neben den zwei Polen noch über einen dritten Pol zur Erdung. Der breite Pol bzw. der Erdungspol dienen der Sicherheit. Wenn der zur Verfügung gestellte Stecker nicht in Ihren Anschluss passt, konsultieren Sie einen Elektriker, um den veralteten Anschluss zu ersetzen.

¡Advertencia! No eche por tierra la finalidad del tipo de enchufe polarizado con conexión a tierra. Un enchufe polarizado tiene dos espigas, una más ancha que la otra. Un enchufe con conexión a tierra tiene dos espigas iguales y una tercera espiga que sirve para la conexión a tierra. La espiga ancha, o la tercera espiga, sirven para su seguridad. Si el enchufe suministrado no encaja en el tomacorriente, consulte con un electricista para reemplazar el tomacorriente obsoleto.

Aviso! Não anule a finalidade da segurança da ficha polarizada ou do tipo ligação terra. Uma ficha polarizada tem duas lâminas sendo uma mais larga do que a outra. Uma ficha do tipo de ligação à terra tem duas lâminas e um terceiro terminal de ligação à terra. A lâmina larga ou o terceiro terminal são fornecidos para sua segurança. Se a ficha fornecida não couber na sua tomada, consulte um electricista para a substituição da tomada obsoleta.

Avviso! Non compromettere la sicurezza della spina polarizzata o con messa a terra. Una spina polarizzata ha due spinotti, di cui uno più largo. Una spina con messa a terra ha due spinotti e un terzo polo per la messa a terra. Lo spinotto largo o il terzo polo sono forniti per motivi di sicurezza. Se la spina fornita non si inserisce nella presa di corrente, contattare un elettricista per la sostituzione della presa obsoleta.



Warning! Since the Mains plug is used as the disconnection for the device, it must remain readily accessible and operable.

Avertissement! Puisque la prise principale est utilisée pour débrancher l'appareil, elle doit rester aisément accessible et fonctionnelle.

Warnung! Da der Netzstecker als Trennvorrichtung dient, muss er stets zugänglich und funktionsfähig sein.

¡Advertencia! Puesto que el enchufe de la red eléctrica se utiliza como dispositivo de desconexión, debe seguir siendo fácilmente accesible y operable.

Aviso! Dado que a ficha principal é utilizada como a desconexão para o dispositivo, esta deve manter-se prontamente acessível e funcional.

Avviso! Poiché il cavo di alimentazione viene usato come dispositivo di sconnessione, deve rimanere prontamente accessibile e operabile.



Warning! Protect the power cord from being walked on or pinched particularly at plugs, convenience receptacles, and the point where they exit from the device.

Avertissement! Protégez le cordon d'alimentation pour que l'on ne marche pas dessus ou qu'on le pince, en particulier au niveau des prises mâles, des réceptacles de convenance, et à l'endroit où il sort de l'appareil.

Warnung! Vermeiden Sie, dass auf das Netzkabel getreten oder das Kabel geknickt wird, insbesondere an den Steckern, den Steckdosen und am Kabelausgang am Gerät.

¡Advertencia! Proteja el cable de energía para que no se le pise ni apriete, en especial cerca del enchufe, los receptáculos de conveniencia y el punto del que salen del equipo.

Aviso! Proteja o cabo de alimentação de ser pisado ou de ser comprimido particularmente nas fichas, em tomadas de parede de conveniência e no ponto de onde sai do dispositivo.

Avviso! Proteggere il cavo di alimentazione in modo che nessuno ci cammini sopra e che non venga schiacciato soprattutto in corrispondenza delle spine e del punto in cui esce dal dispositivo.



Warning! Unplug this device during lightning storms or when unused for long periods of time.

Avertissement! Débranchez cet appareil pendant les orages avec éclairsoù s'il est inutilisé pendant de longues périodes.

Warnung! Das Gerät ist bei Gewitterstürmen oder wenn es über lange Zeiträume ungenutzt bleibt vom Netz zu trennen.

¡Advertencia! Desenchufe este dispositivo durante tormentas eléctricas o cuando no se lo utilice por largos periodos del tiempo.

Aviso! Desconecte este dispositivo da tomada durante trovoadas ou quando não é utilizado durante longos períodos de tempo.

Avviso! Utilizzare soltanto i collegamenti e gli accessori specificati e/o venduti dal produttore, quali il treppiedi e l'esoscheletro.



Warning! Refer all servicing to qualified service personnel. Servicing is required when the device has been damaged in any way, such as power-supply cord or plug is damaged, liquid has been spilled or objects have fallen into the device, the device has been exposed to rain or moisture, does not operate normally, or has been dropped.

Avertissement! Référez-vous au personnel de service qualifié pour tout entretien. L'entretien est exigé quand l'appareil a été endommagé de quelque manière que ce soit, par exemple lorsque le cordon d'alimentation ou la prise sont endommagés, que du liquide a été versé ou des objets sont tombés dans l'appareil, que l'appareil a été exposé à la pluie ou à l'humidité, ne fonctionne pas normalement ou est tombé.

Warnung! Das Gerät sollte nur von qualifizierten Fachkräften gewartet werden. Eine Wartung ist fällig, wenn das Gerät in irgendeiner Weise beschädigt wurde, wie bei beschädigtem Netzkabel oder Netzstecker, falls Flüssigkeiten oder Objekte in das Gerät gelangen, das Gerät Regen oder Feuchtigkeit ausgesetzt wurde, nicht ordnungsgemäß funktioniert oder fallen gelassen wurde.

¡Advertencia! Consulte al personal calificado por cuestiones de reparación. El servicio de reparación se requiere cuando el dispositivo ha recibido cualquier tipo de daño, por ejemplo cable o espigas dañadas, se ha derramado líquido o se han caído objetos dentro del dispositivo, el dispositivo ha sido expuesto a la lluvia o humedad, o no funciona de modo normal, o se ha caído.

Aviso! Remeta todos os serviços de manutenção para o pessoal de assistência qualificado. A prestação de serviços de manutenção é exigida quando o dispositivo foi danificado mediante qualquer forma, como um cabo de alimentação ou ficha que se encontra danificado/a, quando foi derramado líquido ou caíram objectos sobre o dispositivo, quando o dispositivo foi exposto à chuva ou à humidade, quando não funciona normalmente ou quando foi deixado cair.

Avviso! Fare riferimento al personale qualificato per tutti gli interventi di assistenza. L'assistenza è necessaria quando il dispositivo è stato danneggiato in qualche modo, ad esempio se il cavo di alimentazione o la spina sono danneggiati, è stato rovesciato del liquido è stato rovesciato o qualche oggetto è caduto nel dispositivo, il dispositivo è stato esposto a pioggia o umidità, non funziona correttamente o è caduto



Warning! Do not open the chassis. There are no user-serviceable parts inside. Opening the chassis will void the warranty unless performed by an AJA service center or licensed facility.

Avertissement! Ne pas ouvrir le châssis. Aucun élément à l'intérieur du châssis ne peut être réparé par l'utilisateur. La garantie sera annulée si le châssis est ouvert par toute autre personne qu'un technicien d'un centre de service ou d'un établissement agréé AJA.

Warnung! Öffnen Sie das Gehäuse nicht. Keine der Geräteteile können vom Benutzer gewartet werden. Durch das Öffnen des Gehäuses wird die Garantie hinfällig, es sei denn, solche Wartungsarbeiten werden in einem AJA-Service-Center oder einem lizenzierten Betrieb vorgenommen.

¡Advertencia! No abra el chasis. El interior no contiene piezas reparables por el usuario. El abrir el chasis anulará la garantía a menos que se lo haga en un centro de servicio AJA o en un local autorizado.

Advertência! Não abra o chassi. Não há internamente nenhuma peça que permita manutenção pelo usuário. Abrir o chassi anula a garantia, a menos que a abertura seja realizada por uma central de serviços da AJA ou por um local autorizado.

Avvertenza! Non aprire lo chassis. All'interno non ci sono parti riparabili dall'utente. L'apertura dello chassis invaliderà la garanzia se non viene effettuata da un centro ufficiale o autorizzato AJA.



Warning! Disconnect the external AC power supply line cord(s) from the mains power before moving the unit.

Avertissement! Retirez le ou les cordons d'alimentation en CA de la source d'alimentation principale lorsque vous déplacez l'appareil.

Warnung! Trennen Sie die Wechselstrom-Versorgungskabel vom Netzstrom, bevor Sie das Gerät verschieben.

¡Advertencia! Cuando mueva la unidad desenchufe de la red eléctrica el/los cable(s) de la fuente de alimentación CA tipo brick.

Advertência! Remova os cabos CA de alimentação brick da rede elétrica ao mover a unidade.

Avvertenza! Scollegare il cavo dell'alimentatore quando si sposta l'unità.



Warning! Only use attachments and accessories specified and/or sold by the manufacturer.

Avertissement! Utilisez seulement les attaches et accessoires spécifiés et/ou vendus par le fabricant.

Warnung! Verwenden Sie nur Zusatzgeräte und Zubehör angegeben und / oder verkauft wurde durch den Hersteller.

¡Advertencia! Utilice solamente los accesorios y conexiones especificados y/o vendidos por el fabricante.

Aviso! Utilize apenas equipamentos/acessórios especificados e/ou vendidos pelo fabricante.

Avviso! Utilizzare soltanto i collegamenti e gli accessori specificati e/o venduti dal produttore.



Hazard! High Voltage. This situation or condition can cause injury due to electric shock.

Avertissement! Tension élevée. Cette situation ou condition peut causer des blessures dues à un choc électrique.

Warnung! Hochspannung. Diese Situation oder Bedingung kann zu Verletzungen durch Stromschlag führen.

¡Advertencia! Alto voltaje . Esta situación o condición puede causar lesiones debidas a una descarga eléctrica.

Aviso! Alta Tensão . Esta situação ou condição pode causar danos devido a choques elétricos.

Avviso! Alta tensione. Questa situazione o condizione può causare lesioni a causa di scosse elettriche.



Caution! To meet safety regulations for leakage current, connect the dual power supplies to separate branch circuits.

¡Advertencia! Para cumplir con las normas de seguridad para la corriente de fuga, conecte las dos fuentes de alimentación para circuitos derivados diferentes.

Attention! Pour répondre aux mesures de sécurité concernant le courant de fuite, raccorder les sources d'alimentation doubles à des circuits de dérivation distincts.

Warnung! Zur Erfüllung der Sicherheitsbestimmungen bezüglich Reststrom schließen Sie bitte die zwei Netzteile an unterschiedlichen Abzweigleitungen an.

Cuidado! Para atender aos regulamentos de segurança para correntes de fuga, conecte as fontes duplas a circuitos elétricos separados.

Attenzione! Per soddisfare le norme di sicurezza sulla corrente di perdita, collegare i doppi alimentatori a circuiti derivati separati.



Warning! Ensure Mains Power is disconnected before installing the OG-4K2HD modules into the frame, or installing and removing options. If a Mains switch is not provided, the power cord(s) of this equipment provide the means of disconnection. The socket outlet must be installed near the equipment and must be easily accessible.

Avertissement ! Avant d'installer des modules OG-3-FR dans la structure, ainsi qu'avant d'installer ou d'enlever des options, assurez-vous d'avoir déconnecté l'alimentation électrique. S'il n'y a pas d'interrupteur électrique, il faut débrancher les câbles électriques de l'équipement. La prise électrique doit être située à proximité de l'équipement et doit être aisément accessible.

Achtung! Sicherstellen, dass die Netzleitung entkoppelt ist, bevor die OG-3-FR Module in das Gestell eingebaut oder Wahlteile eingebaut bzw. ausgebaut werden. Wenn kein Netzschalter vorgesehen ist, dient das bzw. dienen die Netzkabel dieser Vorrichtung als Entkopplungsmittel. Die Steckdose muss in der Nähe der Vorrichtung installiert und leicht zugänglich sein.

Avvertenza. Accertarsi che l'alimentazione di rete sia scollegata prima di installare i moduli OG-3-FR nel frame o di installare e rimuovere componenti opzionali. Se non è presente un interruttore di accensione/spengimento, occorre scollegare il cavo (o i cavi) di alimentazione di questo apparecchio dalla presa di corrente. La presa di corrente deve essere situata presso l'apparecchio e facilmente accessibile.

Aviso! Certifique-se que a fonte principal de energia elétrica está desconectada antes de instalar os módulos OG-3-FR no bastidor ou antes de instalar e remover opções. Se o interruptor principal não existir, o cabo elétrico deste equipamento proporciona o meio de desconexão. A tomada elétrica deverá ser instalada perto do equipamento e deverá ser de fácil acesso.

¡Advertencia! Asegúrese que la red de alimentación está desconectada antes de instalar los módulos OG-3-FR en el marco, o la instalación y extracción de opciones. Si no se proporciona un conmutador de red, el cable de alimentación de este equipo proporciona los medios de desconexión. El zócalo tomacorriente debe estar instalado cerca del equipo y debe ser fácilmente accesible.



Warning! Dual Power Cord Notice—please read this. To reduce the risk of electrical shock, disconnect both power cords before servicing equipment.

Avertissement ! Avis concernant la double alimentation électrique—à lire soigneusement. Pour éviter tout risque d'électrocution, débranchez les deux câbles électriques avant d'intervenir sur l'équipement.

Achtung! Hinweis auf Doppel-Netzkabel-bitte lesen. Um das Risiko eines Elektroschocks zu verringern, müssen beide Netzkabel ausgestöpselt werden, bevor die Vorrichtung gewartet wird.

Avvertenza. Avviso concernente il cavo di alimentazione doppio - leggere attentamente. Per ridurre il rischio di elettrocuzione, scollegare entrambi i cavi di alimentazione prima di eseguire la manutenzione o riparazioni di questo apparecchio.

Aviso! Aviso de Cabo Elétrico Duplo - por favor, leia isto. Para reduzir o risco de choque elétrico, desconecte ambos os cabos elétricos antes de fazer manutenção ao equipamento.

¡Advertencia! Aviso del doble cable de alimentación - leer esto por favor. Para reducir el riesgo de descarga eléctrica, desconecte ambos cables de alimentación antes de dar servicio al equipo.



Caution! The OG-4K2HD front fan door is heavy. Remove with Caution.

Attention! La porte du ventilateur avant OG- 3 - FR est lourde. Retirer avec précaution.

Achtung! Die OG -3- FR -Frontlüfter Tür ist schwer. Bitte vorsichtig entfernen.

¡Precaución! La puerta del ventilador frontal OG- 3 -FR es pesado. Extraer con precaución.

Atenção! A porta do ventilador frontal OG -3- FR é pesado. Remova com cuidado.

Attenzione! La porta ventola anteriore OG -3 - FR è pesante. Rimuovere con cautela.

Warranty and Liability Information

Limited Warranty on Hardware

AJA Video Systems, Inc. (AJA Video) warrants that the hardware product, not including software components, will be free from defects in materials and workmanship for a period of five years from the date of purchase. AJA Video provides a separate software warranty as part of the license agreement applicable to software components.

If the Customer brings a valid claim under this limited warranty for a hardware product (hereafter, a “product”) during the applicable warranty period, AJA Video will, at its sole option and as the Customer’s sole remedy for breach of the above warranty, provide one of the following remedies:

- Repair or facilitate the repair the product within a reasonable period of time, free of charge for parts and labor.
- Replace the product with a direct replacement or with a product that performs substantially the same function as the original product.
- Issue a refund of the original purchase price less depreciation to be determined based on the age of the product at the time remedy is sought under this limited warranty.

To obtain service under this warranty, the Customer must notify AJA Video of the defect before expiration of the warranty period and make suitable arrangements for the performance of service by contacting AJA Video support through the channels set forth on the support contacts web page at <https://www.aja.com/support>. Except as stated, the Customer shall bear all shipping, packing, insurance and other costs, excluding parts and labor, to effectuate repair. Customer shall pack and ship the defective product to a service center designated by AJA Video, with shipping charges prepaid. AJA Video shall pay to return the product to Customer, but only if to a location within the country in which the AJA Video service center is located. SOME JURISDICTIONS DO NOT ALLOW THE EXCLUSION OF IMPLIED WARRANTIES OR LIMITATIONS ON APPLICABLE STATUTORY RIGHTS OF A CONSUMER, SO SOME OR ALL OF THE TERMS OF THIS PARAGRAPH MAY NOT APPLY TO YOU.

Limitation of Liability

Under no circumstances shall AJA video BE LIABLE IN ANY WAY FOR ANY LOST, CORRUPTED OR DESTROYED DATA, FOOTAGE OR WORK, OR FOR ANY OTHER INDIRECT, SPECIAL, INCIDENTAL OR CONSEQUENTIAL DAMAGES OR LOST PROFITS, OR FOR ANY THIRD PARTY CLAIM, IN CONNECTION WITH THE PRODUCT, WHETHER RESULTING FROM DEFECTS IN THE PRODUCT, SOFTWARE OR HARDWARE FAILURE, OR ANY OTHER CAUSE WHATSOEVER, EVEN IF AJA VIDEO HAS BEEN ADVISED OF THE POSSIBILITY OF SUCH DAMAGES. AJA VIDEO’S LIABILITY IN CONNECTION WITH THE PRODUCT SHALL UNDER NO CIRCUMSTANCES EXCEED THE PURCHASE PRICE PAID FOR THE PRODUCT. The foregoing limitations apply even if any remedy set forth in this LIMITED WARRANTY fails of its essential purpose. SOME JURISDICTIONS DO NOT ALLOW THE LIMITATION OF LIABILITY FOR PERSONAL INJURY, OR OF INCIDENTAL OR CONSEQUENTIAL DAMAGES, SO SOME OR ALL OF THE TERMS OF THIS PARAGRAPH MAY NOT APPLY TO YOU.

Governing Law and Language; Your Rights

This limited warranty is the only warranty provided by AJA Video on the hardware product. It supersedes all prior or contemporaneous understandings regarding such subject matter. No amendment to or modification of this warranty will be binding unless in writing and signed by AJA Video. The laws of the State of California, USA will govern this warranty and any dispute arising from it. Any translation of this

Agreement is intended for convenience and to meet local requirements and in the event of a dispute between the English and any non-English versions, the English version of this warranty will govern. This limited warranty gives you specific legal rights and you may have other rights that vary from jurisdiction to jurisdiction, some of which are noted above.

Index

Symbols

- 2K Crop 21
- 2SI 20
- 3Gb Mode 22
- 3G-B Mode 20
- 4K Convert 21
- 4K Down Conversion Mode 5
- 4K/UltraHD Dual-stream 3Gb SDI Input 6

A

- AJA Support 2
- Audio Input Source 27
- Audio Offset In Frames 27
- Audio Tab Screen 27

B

- Bit Depth 20, 23
- Block Diagram 8

C

- Card Name 28
- Card Tab Screen 17
- Center Cut Mode 5
- CLL
 - Maximum 26
- Color Dithering 24
- Colorimetry HDMI Output Override 25
- Color Space 19
- Color Space 23
- Custom HDMI Metadata 26

D

- DashBoard Control 7
- DashBoard Control Functions 7
 - Audio 7
 - HDMI Output 7
 - Input Video Selections 7
 - Output Video Selections 7
- DashBoard Control System 11
 - Audio Tab Screen 27
 - Basic Components 15
 - Card Tab Screen 17
 - Documentation 15
 - Downloading 15
 - HDMI Tab Screen 23
 - HDR Metadata Tab Screen 24
 - Input Tab Screen 19
 - Output Tab Screen 21
 - Rebooting 31
 - Requirements 15
 - Setup Tab Screen 28
 - Status Tab Screen 18
 - Using 15
- Default Operation 6

- DM Lum 26
- Dual-link 1.5Gb Input 6

E

- Edge Filtering 22

F

- Factory Settings
 - Restore 29
- Features 7
- FLL
 - Maximum 26

H

- HDMI Channel Count 27
- HDMI/DVI 24
- HDMI Metadata Output Override 25
- HDMI Output Control
 - Difference From SDI 6
- HDMI Tab Screen 23
- HDR Metadata Presets 26
- HDR Metadata Tab Screen 24

I

- Identify Card 28
- Input Tab Screen 19
- Installation 12
 - Cabling 14
 - Front Card Installation 13
 - Rear Card Installation 12
- I/O Connections 9

M

- Mapping 20
- Maximum: CLL 26
- Maximum: FALL 26
- Modes
 - 4K2HD 5

N

- Non-4K Mode 5

O

- OG-4K2HD
 - Modes 5
- openGear and AJA 8
- Operation 15
- Output Control Differences
 - HDMI and SDI 6
- Output Overrides 25
- Output Tab Screen 21
- Overview 5

P

- Passthrough 22

Presets

- HDR Metadata Factory Settings 26
- Progressive to Interlace Enable 22

Q

- Quadrant 20

R

- Reboot OG-4K2HD 31
- RGB Range 20, 23

S

- Safety and Compliance 38
- SDI inputs
 - Multiple 6
- SDI Output Control
 - Difference From HDMI 6
- SDI Passthrough 6
- SDR/HDR HDMI Output Overrides 25
- Signal Indicators
 - In the DashBoard Control System 10
 - On the OG-4K2HD Card 9
- Single HD Input 6
- Single SD Input 6
- Specifications
 - Tech Specs 32
- Square Division 20
- Status Tab Screen 18

T

- Technical Specifications 32
- Technical Support 2
- Two Sample Interleave 20

U

- Update Software
 - Upload Screen 29
- Uploading New Software 29
- User Controls 11

V

- Video Output 6
- Video Source 19

W

- Warranty 47