

KONA Series

Capture, Display, Convert



Installation and Operation Guide

Version 15.0r1
Published November 27, 2018



Notices

Trademarks

AJA® and Because it matters.® are registered trademarks of AJA Video Systems, Inc. for use with most AJA products. AJA™ is a trademark of AJA Video Systems, Inc. for use with recorder, router, software and camera products. Because it matters.™ is a trademark of AJA Video Systems, Inc. for use with camera products.

CION®, Corvid Ultra®, Io®, Ki Pro®, KONA®, KUMO®, ROI® and T-Tap® are registered trademarks of AJA Video Systems, Inc.

AJA Control Room™, KiStor™, Science of the Beautiful™, TruScale™, TruZoom™, V2Analog™ and V2Digital™ are trademarks of AJA Video Systems, Inc.

All other trademarks are the property of their respective owners.

Copyright

Copyright © 2018 AJA Video Systems, Inc. All rights reserved. All information in this manual is subject to change without notice. No part of the document may be reproduced or transmitted in any form, or by any means, electronic or mechanical, including photocopying or recording, without the express written permission of AJA Video Systems, Inc.

Contacting AJA Support

When calling for support, have all information at hand prior to calling. To contact AJA for sales or support, use any of the following methods:

Telephone	+1.530.271.3190
FAX	+1.530.271.3140
Web	https://www.aja.com
Support Email	support@aja.com
Sales Email	sales@aja.com

Contents

Notices	2
Trademarks	2
Copyright	2
Contacting AJA Support	2
Chapter 1 – Introduction	5
Overview	5
KONA Models Covered in this Manual	5
AJA Software & Utilities	5
System Requirements	6
Disk Storage Methods	7
KONA 5 Features	7
KONA 5 Card Connectors	8
KONA 4/3G Features	10
KONA 4 Only Features	11
KONA 4/3G Connectors On Card	11
KONA 4/3G Breakout Cable Connections	12
K3G-Box for KONA 4 & 3G	12
KONA 1 Features	15
KONA 1 Connectors	16
Chapter 2 – Installation	17
Installation Overview	17
AJA System Test Application	17
Unpacking	17
Shipping Box Contents	17
Installing the KONA Card	18
Cabling the System	20
KONA 4/3G Cable Connections	20
Installing KONA Software	21
Download	21
Software Package Installation and Re-installation	21
Firmware Update Procedure	22
Firmware Versions	23
Chapter 3 – Operation	24
Using KONA with Professional Video /Audio Software	24
Capture Formats	24
AJA Control Panel Overview	24
AJA Control Panel User Interface	25
Controlling Application	28
Presets	28
Single-User & Shared Preferences	28
Function Screens	29
About KONA Modal Operation	30
Control Panel Operation in Standard or UFC Mode	31
Control Screen	31
Format Screen	33
Input Select Screen	36
SDI Out Screen	37
HDMI Screen	39
Analog Out Screen	40
Video Setup Screen	41
Audio Setup Screen	42
Audio Mixer Screen	44
Conversion Screen (Mac OS only)	45
Downstream Keyer Screen	47
LUT Screen	50

Timecode Screen	52
Presets Screen	54
Firmware Screen	55
Info Screen	56
Control Panel Operation in 4K Mode	56
4K Transport Modes	56
Control Screen in 4K Mode	58
SDI Out Screen in 4K Mode	60
HDMI Screen in 4K Mode	61
HDMI HDR Screen (KONA 4 in 4K Mode)	62
Analog Out Screen in 4K Mode	64
Video Setup Screen in 4K Mode	65
Audio Mixer Screens (KONA 4 in 4K Mode and KONA 1)	65
Audio Mixer Playback Monitor Mode Screen	67
Audio Mixer Capture Monitor Mode Screen	69
Downstream Keyer Screen in 4K Mode	70
Who is Controlling KONA?	70
Using Multiple AJA Products	71
Notes on Using Multiple AJA Products:	72
Using 8-bit Versus 10-bit Video.	72
Appendix A – Specifications	73
KONA 5 Tech Specs	73
KONA 4 Tech Specs	75
KONA 3G Tech Specs	79
KONA 1 Tech Specs	82
Appendix B – Safety & Compliance.	84
Warranty and Liability Information	91
Limited Warranty on Hardware.	91
Limitation of Liability	92
Governing Law and Language; Your Rights.	92
Index.	93

Chapter 1 – Introduction

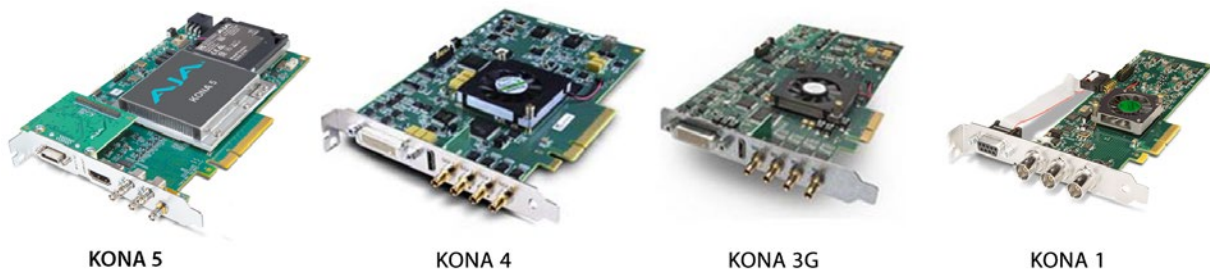

Overview

The AJA KONA series cards brings the highest quality 4K/UltraHD, 2K, HD, and SD video and audio to computers running Mac, Windows or Linux Operating Systems.

KONA Models Covered in this Manual

This manual covers the installation and operation of these models:

- KONA 5
- KONA 4
- KONA 3G
- KONA 1

NOTE: The KONA LHe Plus and KONA LHi cards share a separate AJA manual, and the KONA IP and KONA HDMI cards each have a separate AJA manual.

AJA Software & Utilities

AJA's KONA software and hardware were developed for powerful integrated video/audio capture, editing, and production with a variety of 3rd-party software. With KONA and a qualified computer, you have the ultimate system for production, post-production, broadcast, and streaming work. AJA software is distributed as a unified package which includes all the software, firmware, plugins, and utility programs for AJA's Io, KONA, and T-TAP products.

Four retail packages are available, one for Mac, one for Windows, and two for Linux (one package for Ubuntu, one package for Red Hat/CentOS).

NOTE: Support for the Linux OS retail drivers is based on the Linux application used and comes from the application's vendor.

To download AJA software, go to the AJA website:

<https://www.aja.com/en/support/downloads>

For a complete software compatibility list, see the AJA website link:

<https://www.aja.com/en/category/edit/compatibility>

Mac, Windows and Linux Packages

These packages include:

Drivers

AJA device drivers for tightly integrated hardware/software operation.

AJA Control Panel

The Control Panel provides:

- Source selection and control of your AJA hardware.
- A block diagram to show visually what routing and processing is being performed.

AJA Control Room

Control Room is a cross-platform software application for ingest, playback and output with AJA devices.

AJA System Test

System Test provides accurate and detailed evaluations of drive and system performance statistics, allowing you to measure the capabilities of your system for recording and playing back various resolutions and codecs. The application includes:

- System Disk Test
- AJA Device Test
- Disk + Device Test
- System Report

The application tests Read and Write, Capture and Playback speeds in both Megabytes per second and Frames per second. The disk speed tests differ from standard disk I/O performance applications in that they specifically test the system under conditions typically encountered with video capture, playback, and editing.

NOTE: Theoretically the best test is to fill your storage disk to 80% and then test capture at the highest data rate you will use.

Additional with Mac and Windows Packages

3rd-Party Plugins

AJA provided plugins for popular 3rd-party Professional Video Applications from Adobe, Avid, Apple, and Telestream.

System Requirements

AJA Video recommends that your system meet minimum hardware and software requirements to achieve a satisfactory level of performance. Updates to system requirements are subject to change.

NOTE: See Software Vendor system requirements for GPU recommendations and additional hardware requirements and recommendations.

AJA recommends:

- Mac OS 10.12 Sierra or later
- Win 10 or later with all updates

- Linux Redhat/CentOS 7
- Linux Ubuntu 14.04 LTS and Ubuntu 16.04 LTS
- 2.5 GHz quad core i7 minimum, for HD
- 3.5 GHz eight core minimum, faster processors and more cores recommended, for UltraHD/4K workflows, especially with high frame rate
- 16GB RAM minimum, 32GB or more recommended, especially for UltraHD/4K or High Frame Rate applications
- A reasonably fast and powerful graphics card, with plenty of on-board memory. Examples (may be specific to application version and/or host CPU) include:
 - Nvidia K5200
 - Nvidia K4200
 - Nvidia M6000
 - Nvidia M5000
 - Nvidia M4000
 - AMD W7100
 - AMD W8100
- Media storage with adequate bandwidth to sustain the capture and playback of the material you expect to be working with.

NOTE: For large scale installations with shared storage, or for very high performance requirements, AJA recommends consultation with an experienced a system integrator. A consultant will be able to assist with many important variables.

Disk Storage Methods

To ensure performance and quality, the disk storage system used with the workstation must be able to meet the demands of storing real-time uncompressed media. At the very minimum, the disk storage system must be able to provide and maintain a consistent transfer rate from the workstation to disk (read/write). There are a variety of system configurations and peripherals that can provide this level of performance.

For more on disk storage performance see ["AJA System Test Application" on page 17](#).

KONA 5 Features

KONA 5 Card Only

- Four bidirectional SDI locking HD-BNCs configurable for up to four inputs, or four outputs, or two inputs and two outputs.
- Single Link I/O for 4K/UltraHD, HD and SD across 12G-SDI, 6G-SDI, 3G-SDI, and 1.5G-SDI
- Dual Link I/O for 1.5G-SDI and 3G-SDI (2x HD-BNC)
- Quad Link I/O for 1.5G-SDI, 3G-SDI (4x HD-BNC)
- Supports Quadrant or Two Sample Interleave transport
- HDMI 2.0 Output
- HDR (HDR10 or HLG via HDMI, 12 Bit RGB, BT2020)
- Up to 16 channels of SDI embedded audio
- Up to 8 channels of HDMI embedded audio
- Reference In BNC

KONA 5 Card with Breakout Cable

- Up to four channel pairs of AES audio on full size BNC connectors, configurable as two pairs in and two pairs out, or all four pairs in, or all four pairs out.
- Reference In/LTC In (selectable)
- LTC Output
- RS-422 control via 9-pin

KONA 5 Card Connectors

Figure 1. KONA 5 Card



The KONA 5 endplate provides five twist-lock HD-BNC connectors:

- One Reference/LTC input HD-BNC connector (#5 bottom)
- Four 12G-SDI capable bi-directional HD-BNC connectors (#1-#4)

KONA 5 offers one 4K/UltraHD input (over 1x 12GSDI) and passthrough of one 4K/UltraHD Output (over 1x 12GSDI), and additional monitoring is also available via HDMI.

A multi-pin connector at the top of the card attaches to the supplied breakout cable.

Five short HD-BNC (locking) to full size BNC adapter cables are also provided.

KONA 5 Breakout Cable

Figure 2. KONA 5 Breakout Cable



NOTE: KONA 5 breakout cables cannot be used with KONA 4/3G cards, and vice versa.

The six-foot long KONA 5 breakout cable has a multi-pin connector for the rear of the KONA 5 card, and on the other end has the following full size BNC connectors:

- AES Ch 1/2 In
- AES Ch 3/4 In
- AES Ch 5/6 In
- AES Ch 7/8 In
- AES Ch 1/2 Out
- AES Ch 3/4 Out
- AES Ch 5/6 Out
- AES Ch 7/8 Out
- LTC In
- LTC Out

In addition, one female 9-pin D connector on the breakout cable provides RS-422 Machine Control for devices using RS-422 SMPTE (Sony protocol).

Figure 3. KONA 5 Breakout and Adapter Cables

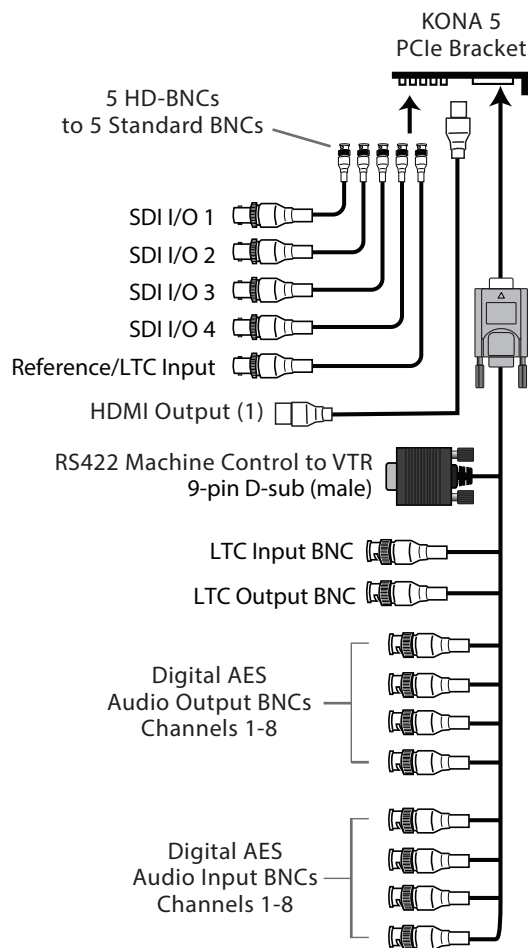

KONA 4/3G Features

Video I/O

- SD-SDI, HD-SDI, Dual Link HD-SDI, HSDL, and 3G HD-SDI inputs
- HDMI 1.4b output
 - KONA 3G I/O supports SD and HD over HDMI
- HDMI v2.0
 - 30/36 bits/pixel, RGB or YUV, 2.25 Gbps
 - 2K, HD, and SD, UltraHD with HFR support up to 60p 4:2:0
 - HDR10 Support - HDR Infoframe metadata, in accordance with HDMI 2.0a/CTA-861.3
- 2K support that includes 2048x1556 and 2048x1080 formats
- 4K and UltraHD capture and playout
 - KONA 3G supports frame rates up to 30 fps
 - KONA 4 supports frame rates up to 60 fps
- 12-bit HD component analog video and SD analog component or composite and s-video output
- 10-bit HD/SD Video+Key Output
- HD/SD Hardware Downstream Keyer

KONA 4/3G supports Dual Link HD-SDI (4:4:4). KONA 4/3G supports the ingest and output of SMPTE-372M compliant 4:4:4 RGB video and 4:2:2 1080p 50, 1080p 59.94, and 1080p 60 at 10-bit.

Conversion

- Broadcast quality hardware-based 10-bit down-conversion
- Broadcast quality hardware based 10-bit up-conversion
- Broadcast quality hardware based 10-bit cross-conversion (1080 to 720 and 720 to 1080)
- Broadcast quality hardware based 10-bit SD aspect ratio conversion (anamorphic to letterbox, etc.)

KONA 4/3G features hardware-based full 10-bit broadcast quality motion adaptive SD to HD up-conversion, HD to SD down-conversion and HD to HD cross-conversion. The quality of the conversion features found in the KONA 4/3G is virtually identical to AJA's award winning stand-alone converter products used throughout the post production market. The KONA 4/3G built-in up-converter uses a full 10-bit path, fully motion adaptive de-interlacing, and large multi-point digital interpolators. Down-conversion uses large multi-point digital interpolators, anti-alias filtering and interpolation.

Cross-conversion is high-quality hardware-based, providing capability to streamline dailies and offers true broadcast picture quality in real time. Because these functions are in hardware on the card, they are available full time, all the time—with no CPU load. Such conversions are useful for cost effective monitoring, making standard definition dubs of an HD project, or upconverting from a standard definition project to an HD deliverable.

Audio I/O

- 8-channel 24-bit, 48kHz digital AES/EBU audio
- 16 channels of SDI embedded digital audio

KONA 4/3G supports 8-channel 24-bit 48kHz AES audio via full size BNC connections on the supplied breakout cable—or with the optional K3G-Box, 16-channels of AES audio.

KONA 4/3G's high-quality input sample-rate conversion on AES inputs eliminates the need for audio source synchronization. Sample rate converters auto-lock to any AES input, 32-96kHz, and then convert it to 24-bit 48kHz audio, locked to internal KONA 4/3G video. Sample rate conversion is done at very high quality (over 120db THD).

Signal Timing

- Genlock input with optional looping capability via the K3G- Box (terminated on the supplied breakout cable)
- LTC (longitudinal timecode) input/output

Cabling

- Standard 2-meter length connection cables including HDMI mini to HDMI output

UltraHD/4K Mode Capture and Playback

In 4K Mode, KONA 4/3G offers 4K capture and playback in both YCbCr and RGB.

When using a capture application that supports 4K geometry, the KONA 4/3G maps connectors SDI1 through SDI 4 as inputs for 4K video.

When 4K payout in Quadrant mode is selected, the four SDI connectors are remapped as outputs for driving the four quadrants of a 4K display. A large number of 4K formats are supported for this workflow; see the specifications ("[KONA 4 Tech Specs](#)" [on page 76](#)) for supported 4K formats. For a description of Two Sample Interleave output mapping, see "[2SI Mode](#)" [on page 58](#).

Internal HD/SD Hardware Downstream Keyer

KONA 4/3G provides a powerful hardware keyer that can place graphic files with an alpha channel over video in a selectable matte or the contents of the card's framebuffer from a software application (including AJA TV). Key a bug or text over picture and avoid what might normally be a lengthy software render. Also, working with these software applications, you can key video that has an alpha-channel over video input or a matte. For example, you can load a QuickTime clip that has an alpha-channel (a flying logo generated in the Animation codec) into AJA TV and then place it over live video coming into the card and then passing both on to a VTR for recording or broadcast.

KONA 4 Only Features

KONA 4 supports all the KONA 3G features listed above, and also supports:

- Quadrant and Two Sample Interleave transport standards for UltraHD and 4K video formats
- HDR signaling and monitoring for HDR10 and HLG
- Audio Monitoring Mixer, including Host Computer and Application

KONA 4/3G Connectors On Card

Each KONA 4 and KONA 3G card is equipped with:

- Four DIN 1.0/2.3 sliding sleeve video connectors on the card endplate (a DIN to full size BNC adapter cable snake is provided).
- One mini-HDMI output connector
- One multi-pin female D connector for use with the breakout cable provided with the card.

KONA 4/3G Breakout Cable Connections

NOTE: KONA 4 and KONA 3G breakout cables are interchangeable. However, these cables cannot be used with KONA 5 cards, and vice versa.

KONA offers unsurpassed cable connectivity for a video/audio capture card. Connections are made via the breakout cable (included with the card) and connectors mounted on the KONA Card endplate.

KONA 4/3G provides complete I/O connectivity choices in two multi-signal breakout cables and one HDMI-to-HDMI mini output cable. One multi-signal cable provides AES/EBU digital BNC connections and analog video monitoring connections. The other has four DIN 1.0/2.3 small connectors on one end and four full size BNCs on the other providing SDI connections. Cable connections are marked on both the KONA card endplate and on the cable connectors for easy identification.

Figure 4. KONA 4/3G Breakout and Adapter Cables

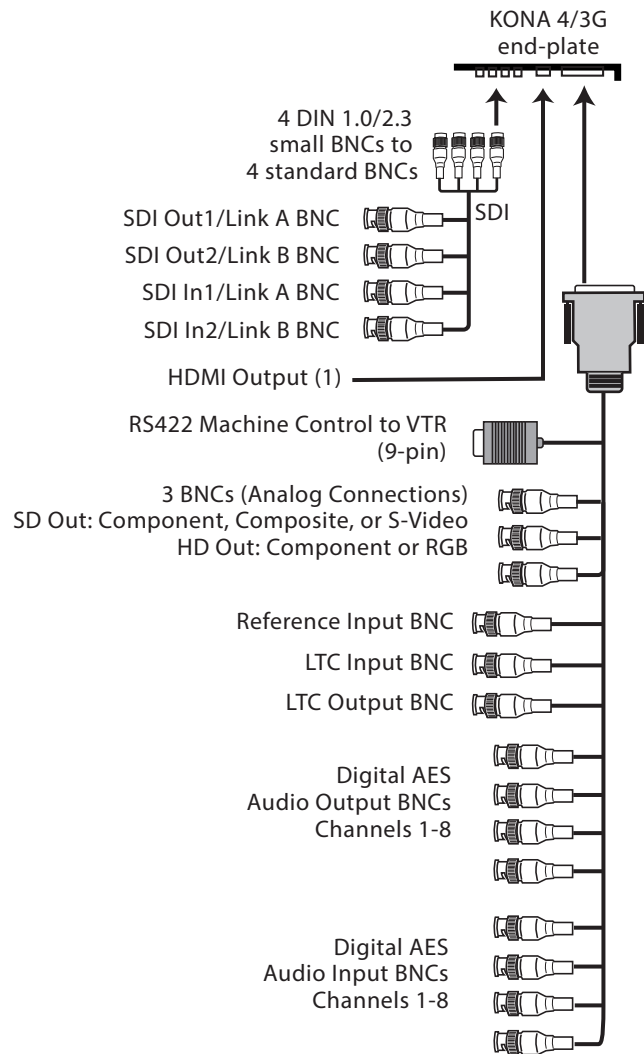

K3G-Box for KONA 4 & 3G

An optional 19" 1RU rack-mountable breakout box is available that attaches to the KONA 4/3G card via cables that connect to the back of the breakout box. These cables are supplied with the breakout box. Breakout boxes can be easily rack mounted or placed on top of a broadcast monitor or editing desk.

The K3G-Box for KONA 4 and 3G offers convenient connector access and additional functionality including simultaneous BNC AES output, 2-channel RCA analog audio monitoring, and looping BNC connection for Genlock reference and LTC timecode. If you're using a digital Betacam deck, HDCAM, DVCPRO HD, D5, D9 or even an HDCAM SR, you'll have the proper connections.

Figure 5. K3G-Box Model Breakout Box (front view)

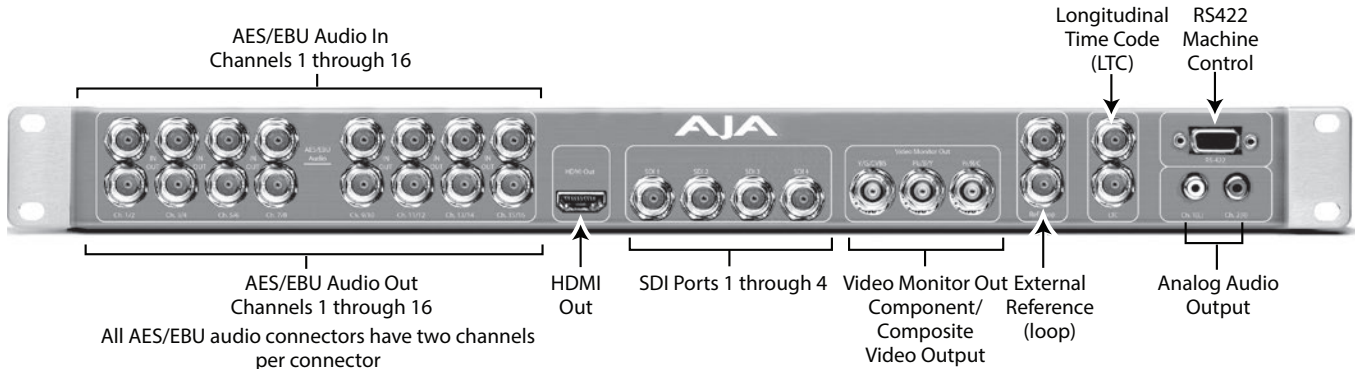
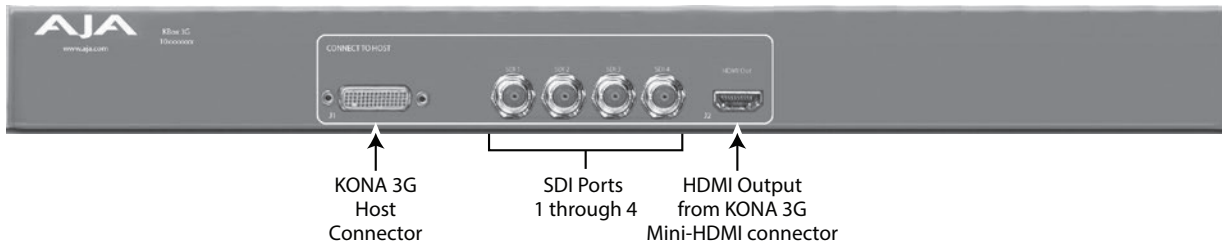

Figure 6. K3G-Box Model Breakout Box (rear view)



KONA 4/3G to K3G-Box Connectors

Connectors on the standard cable set are labeled for their function for easy installation and maintenance. Connectors on the optional K3G-Box (breakout box) are similarly labeled.

8-Channel Digital AES/EBU Audio I/O

When using the standard cables, BNC connections are provided for AES/EBU audio input/output. Four BNC connectors are provided for audio input and four for audio output. Each BNC carries two channels. The connectors are labeled for input/output and channels.

The optional K3G-Box provides BNC audio connections on the front panel for 16-channels of audio input and output.

Unbalanced Audio on K3G-Box

The K3G breakout box has two analog output connectors, one for each channel. These connectors are RCA-style phono jacks.

RS-422 Machine Control

A female DE-9 connector provides connection for VTRs, camcorders, disk media servers, and other devices using RS-422 SMPTE (Sony) protocol. This connector is present on both the general I/O cables and the optional K3G-Box (connector pinout is Sony 9-pin protocol).

SDI Inputs & Outputs

On the KONA 4/3G card, DIN 1.0/2.3 sleeve locking small connectors are provided for bi-directional SDI inputs and outputs for Single Link, Dual Link or 4K/UltraHD I/O. A cable with four DINs on one end and four BNCs on the other end is provided for connecting equipment to the SDI inputs and outputs.

In Standard mode, KONA 4/3G offers four video outputs altogether:

- 2 SDI outputs that are used for both High- and Standard-definition (SD/HD-SDI)
- 2 monitor outputs (discussed later), one component analog and one HDMI 1.4a.

Each of the four outputs is independently switchable between HD and SD. For example, if you are working in HD, you can have simultaneous HD-SDI, SD-SDI, and HD-component analog output.

In 4K Mode, KONA 4/3G offers one 4K/UltraHD input (over 4x 3GSDI) or one 4K/UltraHD output (over 4x 3GSDI), and additional monitoring is also available via HDMI.

SDI inputs and outputs support video and 16-channel embedded 24-bit digital audio.

Use SDI wherever possible for the best quality uncompressed video input, capture, and output. If peripheral equipment has a variety of inputs/outputs, look to see if it has SDI I/O, and use it wherever possible. Most high-end professional broadcast equipment supports SDI (VTRs, cameras, media storage servers, etc.).

HDMI Output

An HDMI mini-connector on the KONA 4/3G endplate (full-size HDMI connectors on the K3G-Box) provides HDMI 1.4 capability, supporting 4K up to p30 on KONA 3G, and UltraHD at up to p60 on KONA 4.

NOTE: KONA 4/3G support SD and HD over HDMI. KONA 4 also supports UltraHD and 4K up to 60over HDMI.

HDMI also supports multi-channel embedded audio (8 channels). HDCP is not supported on the output.

Analog Monitor Outputs

Both the standard I/O cable and the optional K3G-Box feature two groups of three BNC connectors each, for input and output of component, composite and Y/C functions. The signals are labeled on both the cable and K3G-Box connectors.

The analog component output can be switched between SD and HD. KONA 4/3G features 12-bit component video output for both HD and SD. SD can be switched to composite and Y/C. (The same three BNC connectors share component and Y/C functions.) This allows use of an inexpensive analog monitor for both HD and SD work. You can even use a composite video monitor. For Dual Link HD-SDI output, HD or SD can be monitored through the component output. Dual Link HD can be output as 4:4:4 RGB.

Component video signals are generally higher quality than composite, but not as high-quality as serial digital (SDI).

About RGB

Although RGB is used less in today's video systems, KONA 4/3G supports it for A/V Monitor output. However, because the KONA 4/3G (and SMPTE SDI's) native format is YPbPr, AJA recommends using YPbPr when the monitor supports it. The YPbPr format provides headroom for "superwhite" and "superblack", and

these video levels will be clipped when transcoding to RGB. Also, the RGB/YPbPr transcoding involves a level translation that results in mathematical round-off error. RGB can be configured in the Playout setup panel of the specific application you are using with KONA 4/3G.

About YPbPr

KONA 4/3G supports three different types of YPbPr:

- SMPTE/EBU N10
- Betacam (NTSC)
- Betacam (NTSC-J [Japan])

These three formats differ in level only and can be configured in the Playout setup panel of the specific application you are using with KONA 4/3G.

Reference Video

A single BNC on the standard KONA cable—or two BNC connectors on the K3G-Box (looping)—allow you to synchronize KONA outputs to your house analog reference video signal (or black burst). If you have a sync generator or central piece of video equipment to use for synchronizing other video equipment in your studio, connect its analog composite output here. When KONA outputs video, it locks to this reference signal. When connecting a reference video source, the locking signal should be the same format as the Primary format selected in KONA software. It is possible in some circumstances to use an alternate format video signal if the basic frame rate is compatible.

KONA 1 Features

- 3G-SDI formats supported
- Embedded SDI audio in
- Embedded SDI audio out
- Mini PCIe form factor
- Genlock with reference input
- LTC input
- Internal HD/SD Hardware Downstream Keyer
- RS-422 machine control (9-pin)

NOTE: A Low Profile version of the KONA card with the same functionality is available for developers.

KONA 1 Connectors

KONA 1 BNC Connectors on Card

Figure 7. KONA 1 Card

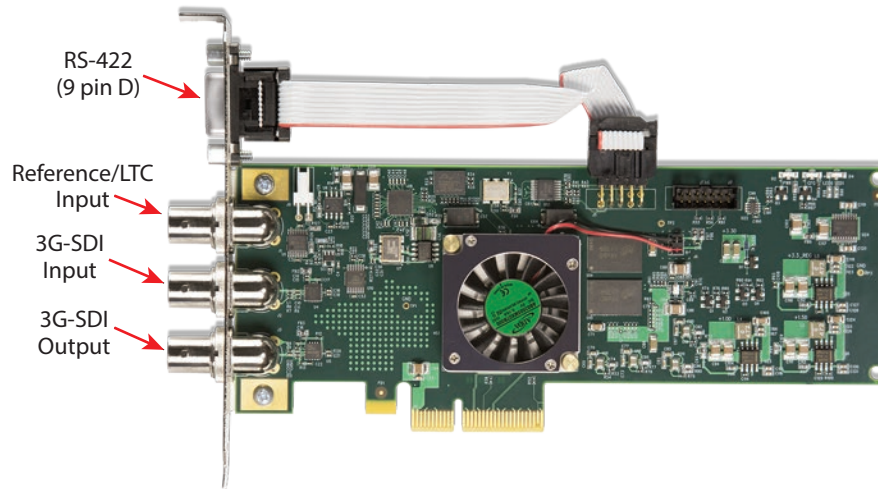

BNC Connectors

The KONA endplate provides three full-size BNCs:

- Reference/LTC input (top)
- 3G-SDI input (middle)
- 3G-SDI output (bottom)

NOTE: KONA 1 uses on-card connectors only. No breakout cable or breakout box is available.

RS-422 Machine Control

A female 9-pin D connector provides connection for VTRs, camcorders, disk media servers, and other devices using RS-422 SMPTE (Sony) protocol.

Chapter 2 – Installation

Installation Overview

The installation and set up of a KONA card is simple, and may vary slightly depending on your system.

For the most up-to-date Mac system requirements for KONA, see the following AJA website:

<https://www.aja.com/en/support/kona-system-configuration/>

For the most up-to-date Windows system requirements for KONA, see the following AJA website:

<https://www.aja.com/en/support/kona-pc-system-configuration/>

AJA System Test Application

AJA System Test is a utility for measuring system performance with AJA KONA Video Capture cards. It is installed with the KONA Driver. The application includes:

- System Disk Test
- AJA Device Test
- Disk + Device Test
- System Report

The application tests Read and Write, Capture and Playback speeds tests in both Megabytes per second and Frames per second. The disk speed tests differ from standard disk I/O performance applications in that they specifically test the system under conditions typically encountered with video capture, playback, and editing.

We suggest the best test is to fill your storage disk to 80% and then test capture at the highest data rate you will use.

Unpacking

As you unpack your shipment, carefully examine the contents. Ensure you received everything and that nothing was damaged during shipping. If you find any damage, immediately notify the shipping service and supply them with a complete description of the damage. AJA will repair or replace damaged items. If you find shipping damage, contact your AJA dealer or distributor for details on how to have your KONA card repaired or replaced.

NOTE: Save packing materials and the shipping box. If you ever require service or move your system use the packaging materials and box for safe shipment.

Shipping Box Contents

Your KONA shipment includes:

- KONA 1, KONA 3G, KONA 4, or KONA 5 PCI-Express card
- Associated cables for the KONA card (see below)

KONA 4/3G Cables

If you purchased the KONA 4 or KONA 3G, you will also receive these cables:

- HDMI mini-to-HDMI output cable
- KONA 4/3G SDI In/Out adapter—small 4x DIN 1.0/2.3 sliding sleeve connectors on the adapter cable are used to connect the KONA card to full-size BNCs for ease of use and compatibility with professional equipment.
- AES BNC digital audio connectors, RS422, and Reference Input.

If you purchased the optional K3G-Box breakout box, it ships with a multi-pin to multi-pin cable for connecting from the KONA 4 or 3G card to the breakout box. The x4 BNC cable to DIN 1.0/2.3 connectors cable that shipped with the card is needed to connect the SDI connectors out of the card to the breakout box. Also, the HDMI cable connects between the KONA 4/3G card and the box rear panel.

NOTE: KONA 5 breakout cables cannot be used with KONA 4/3G cards, and vice versa.

KONA 5 Cables

Provided with the KONA 5 card are:

- 1x multi-pin breakout cable, 6 feet
- 5x HD-BNC (twist lock) to full-size BNC adapter cables

Installing the KONA Card

Figure 8. KONA Card Example



The KONA card can be installed into a PC chassis, legacy Mac Pro chassis with PCIe slots, or into a Thunderbolt PCIe external chassis.

IMPORTANT: The KONA 5 card requires ATX power. For customers who wish to use a Thunderbolt 3 expansion chassis, the chassis must provide ATX connectivity and adequate power.

1. Turn off power to the host chassis.
2. Touch the outside of the chassis to discharge any body static.
3. Remove the power cable from the back of the chassis.
4. Open the chassis.
5. Locate a recommended PCIe slot (see the AJA website for slot selection instructions).
6. Remove the backplate from the PCIe slot.

7. Touch the chassis to discharge any body static.
8. Remove the KONA card from its anti-static bag.
9. Carefully insert the card by rocking it slowly into the slot. Ensure the card aligns properly with the slot opening and is fully seated.
10. (KONA 5 card only). Connect an ATX power cable from the host motherboard to the rear of the KONA 5 card.

Figure 9. KONA 5 ATX Power Connection



11. Secure the card in the chassis.
12. Close the chassis.
13. Power up the chassis.

NOTE: Always put a RAID controller and KONA on separate PCIe buses. This improves performance by reducing bus contention.

Cabling the System

KONA 4/3G Cable Connections

Figure 10. Typical KONA 4/3G System Connections

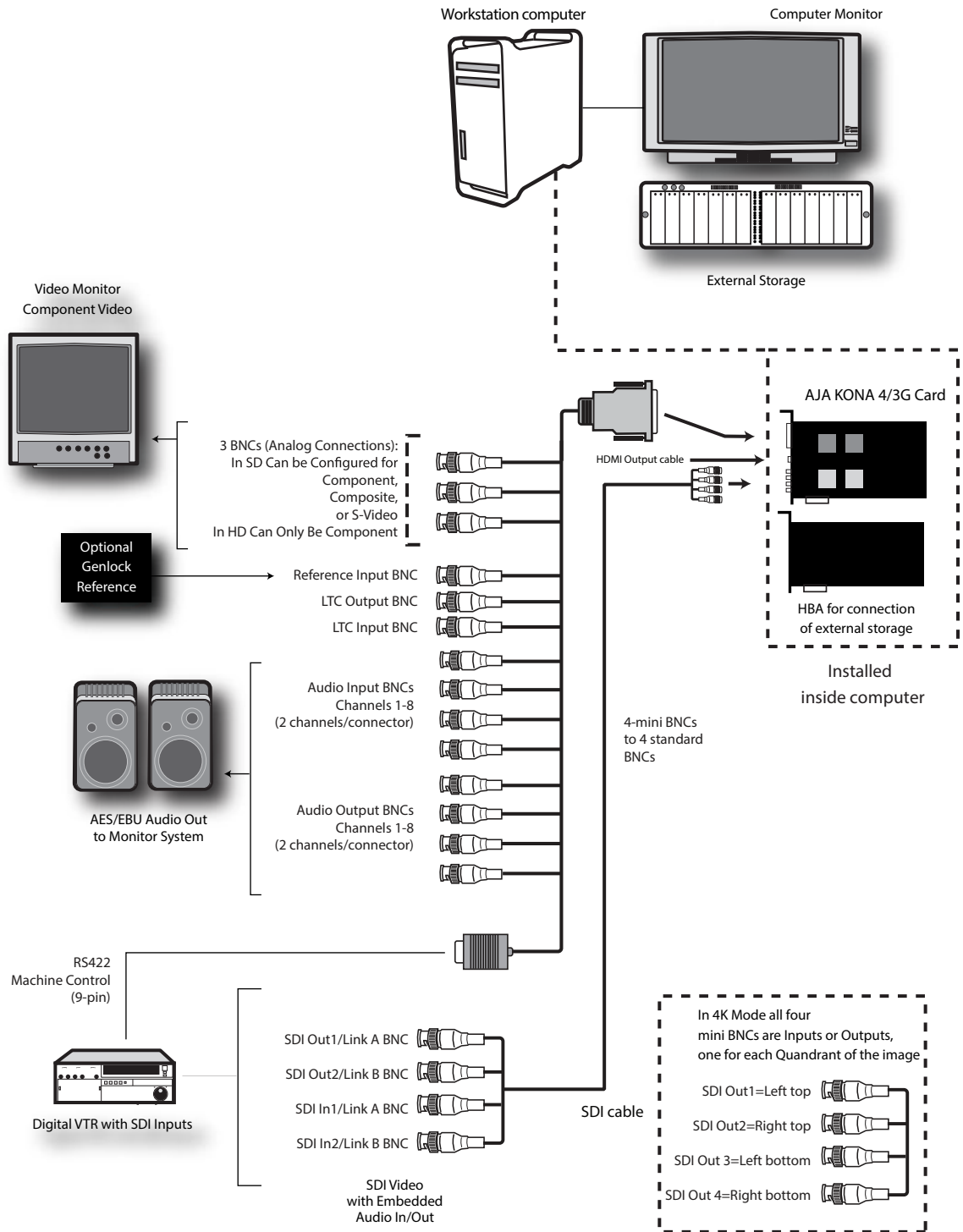

Typical System

Figure 10 on page 20 shows typical system interconnections for a system with digital A/V sources. Your system may differ depending on VTRs, audio monitoring, and video monitoring.

1. If desired, connect your house reference sync to the KONA 4/3G Ref Loop connector (BNC). On the breakout cable this is a terminated reference input. The second KONA 4/3G Ref Loop connector on the optional Breakout Box can be connected to your VTR. If you do not loop through the reference, the second connector should be terminated with a 75-ohm terminator.
2. Connect a Video Monitor to the KONA 4/3G Component Analog Video Out BNC connectors (preferred), or instead connect to a composite monitor. (If you have an SDI or HD-SDI enabled monitor, you may also connect one of the KONA SDI outputs to a monitor as well.)
3. Connect the 9-pin DE9 machine control cable on the supplied breakout cable to your VTR's RS422 control port or connect a 9-pin DE9 cable between the breakout box and the VTR's RS422 serial port.
4. Connect two SDI cables between KONA 4/3G and your digital VTR (Digital Betacam etc.), one from KONA 4/3G SDI In to the VTR SDI Out, and one from KONA 4/3G SDI Out (1 or 2) to the VTR SDI In. The KONA 4/3G SDI connections have embedded audio (16-channels) so the VTR must be configured accordingly. These connections will be made via the small DIN 1.0/2.3 sleeve connectors to full size BNC cable or via the optional K3G-Box.
5. If you have an AES/EBU-ready audio monitoring system, then connect the eight channels of AES/EBU output from KONA 4/3G's BNC connectors: 1/2, 3/4, 5/6, and 7/8, to the monitoring system AES/EBU inputs. If you have an analog audio monitoring system, you can use the two RCA-style unbalanced stereo output jacks on the optional K3G-Box for output.

Installing KONA Software

NOTE: Always uninstall previous versions of KONA software before updating your software.

Download

Go to the AJA website and download the latest KONA driver software containing the AJA Control Panel application:

<https://www.aja.com/en/support/downloads/>

System software updates may occasionally become available to AJA KONA owners on our website (www.aja.com). We recommend checking occasionally for both software updates and additional product information.

NOTE: If your computer has previously had another video capture or multimedia device installed, ensure you uninstall any related software before installing KONA. This will prevent any hardware or software conflicts.

Software Package Installation and Re-installation

Before installing the KONA software package, ensure that your capture/editing application is installed as detailed in its user documentation. You cannot use KONA with a third-party application until the application has been installed and run at least once on your workstation. Next, install the AJA software package.

If you add KONA supported applications at a later date and have not previously installed the appropriate drivers, you must run the install program again selecting the appropriate application support software to be installed.

Firmware Update Procedure

After the AJA Software Package has been installed on a computer with your AJA hardware installed, the firmware on that AJA device can be updated if a newer version of firmware is included with that software package.

1. Open the AJA Control Panel application.
2. If more than one AJA device is connected, choose the device you want to update by selecting its name from the drop-down menu at the top of the screen.
3. Go to the Control Panel Firmware Screen.
4. Select the firmware version (if multiple versions exist) in the Desired dropdown.
5. Click on Install. Messages appear and when finished, firmware update completed messages are shown (*Figure 11*).

Figure 11. Update Completed Messages

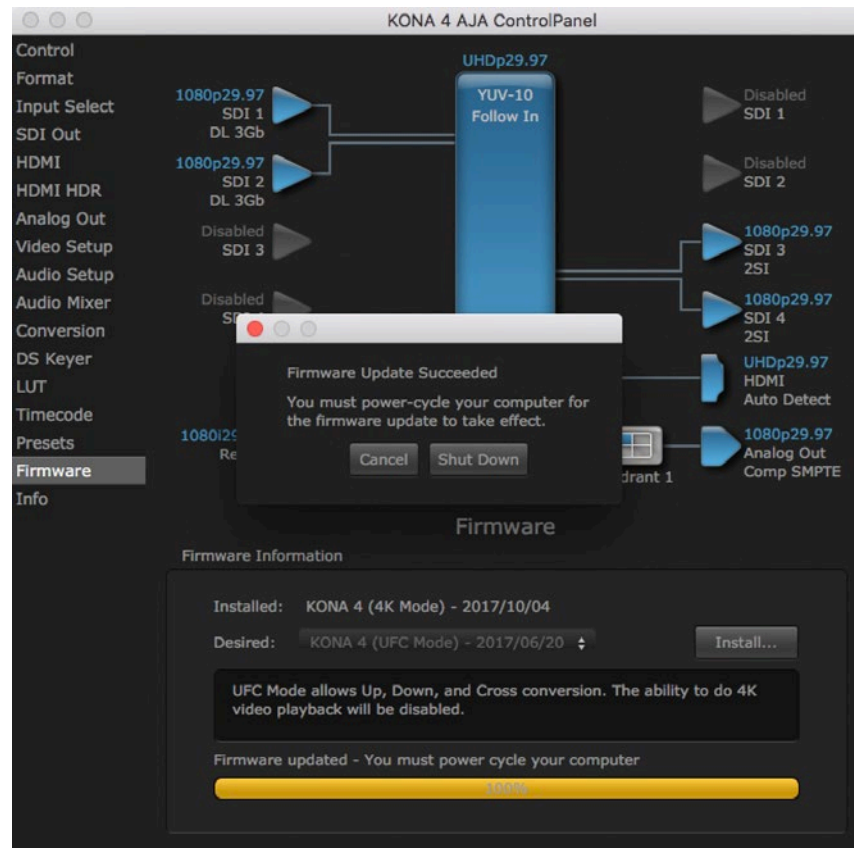

6. Click Shutdown to power down the computer.
7. Restart the computer.
8. Open AJA Control Panel. The AJA hardware with the updated firmware should be recognized by the Control Panel application.

Firmware Versions

KONA 4/3G supports two different versions of firmware that have different capabilities. One version of firmware can be installed at a time.

For KONA 4/3G you can choose to install either:

- Std Mode (KONA 3G) or UFC Mode (KONA 4)—for SD, HD, and 2K formats (allows up/down/cross-conversion).
- 4K Mode—for SD, HD, 2K and UltraHD (3840x2160) and 4K (4096x2160) formats (disables up/down/cross-conversion).

NOTE: KONA 5 and KONA 1 each currently support a single firmware version.

Chapter 3 – Operation



Using KONA with Professional Video /Audio Software

After you install the AJA software package on your computer, you're ready to begin capturing and playing back video and audio using your choice of third-party software. You can go here for AJA software and documentation:

<https://www.aja.com/en/support/downloads/>

For further support information and downloads for third-party software and DirectShow for Developers, go to:

<https://www.aja.com/en/category/edit/compatibility>

Capture Formats

When capturing, you can record data in the following file formats:

- DPX
- TGA
- BMP
- QuickTime

NOTE: Support by KONA of QuickTime for Windows has been discontinued.

- MXF

NOTE: Other file types can be captured using third-party capture applications such as Sienna, Softron, Tools on Air, Drastic, or Quadrus.

AJA Control Panel Overview

The AJA Control Panel is a software application that provides a simple visual showing how the KONA hardware is currently configured and allows you to make changes. You can change signal input and output parameters and define the video processing that will be performed.

The AJA software installer automatically installs the Control Panel application on your computer.

NOTE: KONA 4 and KONA 3G Control Panel functions are virtually the same except for KONA 4's higher frame rates and certain HDMI, Closed Caption, and Analog Out monitoring options for 4K/UltraHD formats. KONA 4 also supports HDR metadata signaling via additional controls within the HDMI tab. KONA 3G Control Panel screen shots are predominately used for this discussion.

AJA Control Panel User Interface

The AJA Control Panel user interface includes a visual block diagram of the unit's current configuration. The current status, input and output settings, and many other details are depicted in the color-coded block diagram. Below this block diagram are various controls for changing operating parameters, which will vary depending on which function screen has been selected.

The left side of the AJA Control Panel provides a navigation list of available function screens. Clicking on a link (or alternatively, a related element in the block diagram) displays a function screen corresponding to that topic.

Figure 12. AJA Control Panel, Block Diagram and Controls

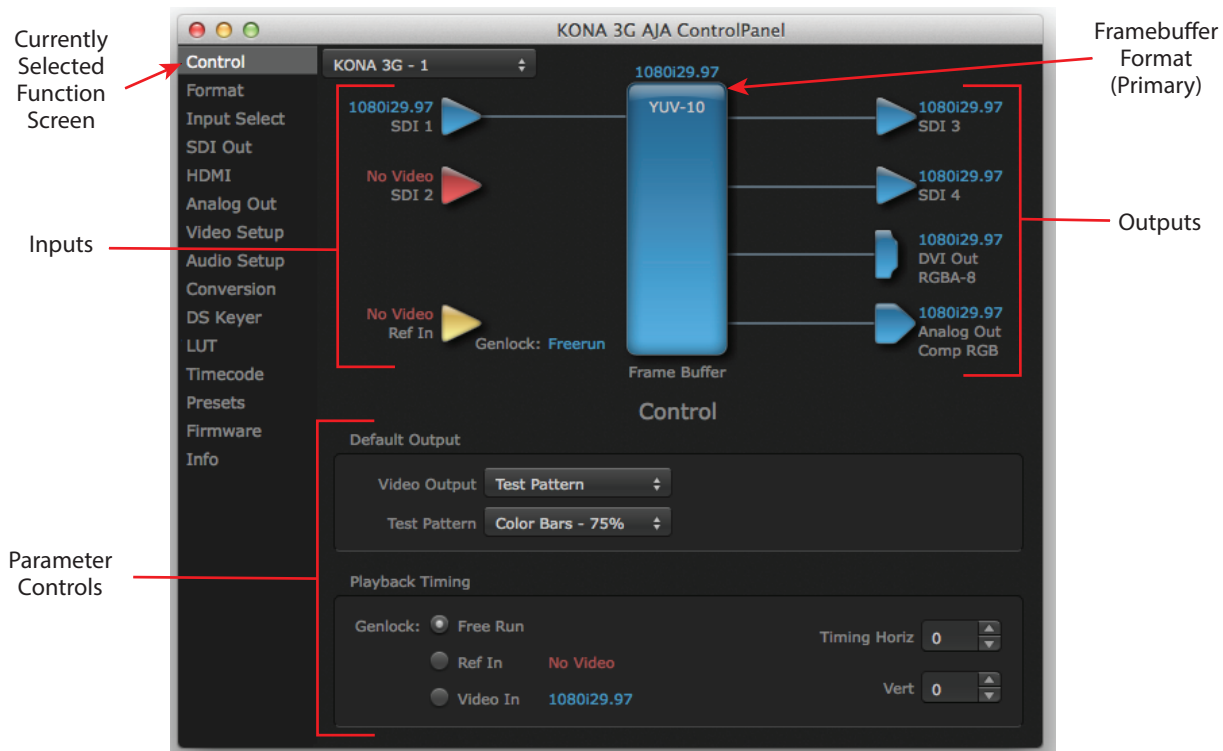

Block Diagram Area

The top block diagram area of the Control Panel screen is a visual representation of the processing, if any, that's currently occurring, including inputs/outputs, reference source, and system status. Lines between inputs, the framebuffer, and outputs, show a video path. Where there are no lines, there is no connection; this can be because an input or output isn't selected in the Input Select menu. The lines will also show whether the outputs are video or video + key.

You can click any of the function screen selection links in the left column to view its current settings or click on an icon to call up its related settings screen. You can also right-click or Control-click to see context-sensitive information and choices.

Figure 13. Context Sensitive Menu

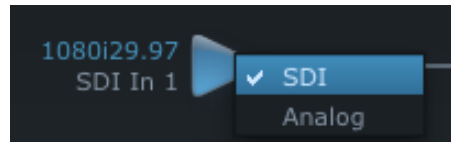

Color Meanings

All items in the AJA Control Panel block diagram are color-coded to show what is happening in real time. This applies to both icons and text. These colors indicate:

Blue

Video is same format as the Primary Format (framebuffer)

Green

Indicates that KONA is performing an active change to the video making it different from the Primary Format (e.g., down-conversion).

Yellow

Reference video (black burst or other reference source)

Red

The selected operation cannot be performed

Input/Output Icons

The input and output icons are triangles that together with their color show all the input and outputs and their status (selected, not selected, input present or not, format, etc.). A complete video path is shown when inputs and outputs are connected with lines going to/from the framebuffer.

Figure 14. Input/Output Icons

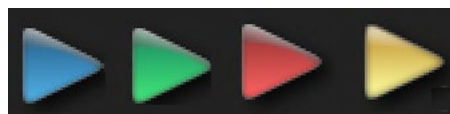

Framebuffer

The framebuffer is the “engine” where your third-party applications interface with the AJA device. The framebuffer has a format (called the “Primary Format”) and color space that it follows, as defined in the linked menu screens or via external application software. The “Secondary Format” is a selection for format conversion.

Primary Format

The Primary Format is the media format written to disk and used in your project. This is the format that the framebuffer will use and is shown in the Control Panel using the color blue. It is the format that the third-party application software will either receive from the AJA hardware, or is sending to the hardware. All icons in blue are the same as the Primary Format used by the framebuffer. Also any text descriptions in the block diagram that appear in blue indicate that something is in the primary format. For example:

- If the input and output icons are blue, you know that the same format is used throughout the video path. No format conversion is being performed.
- If the input or output icon colors differ (blue input and green output icons for example), you know that a format conversion is being performed.

Secondary Format

NOTE: A secondary format is not available on KONA 4/3G operating in 4K Mode or on KONA 1..

Any format other than the currently selected Primary Format, is a secondary format. As described previously, this means that either the Inputs or Outputs are somehow different from the framebuffer's assigned format—the Primary Format. A conversion is readily apparent because of the color change from blue.

In some cases the application you use with the KONA will automatically set the Primary Format, overriding the user's selected primary format in the AJA Control Panel.

Format Screen Conversion

Format function screen conversion allows selection of a format conversion. The choices offered depend on the AJA device present in your system and the Primary and Secondary format selected.

Figure 15. AJA Control Panel, Format Screen

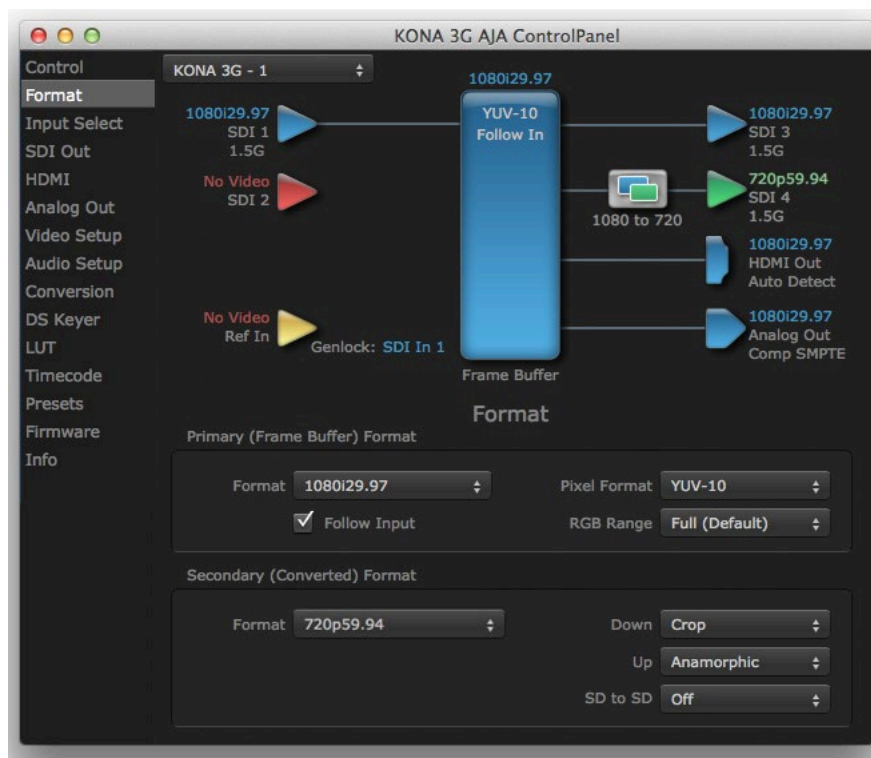

IMPORTANT: Do not confuse this Format function screen conversion, which uses AJA hardware and operates on either Mac or PC, with the separate Conversion function screen, which uses QuickTime for conversion and is only available on Mac.

Conversion Icons

When an input or output is a different standard than the framebuffer, the KONA may be up- down- or cross-converting the signal to the selected standard. This may be automatic, because it's detected an input signal that differs from the standard currently selected, or because you've explicitly told it to convert. In either case, the block diagram will show the conversion by displaying a conversion icon in between the input/output and the framebuffer.

Figure 16. Up, Down, and Cross-convert Icons



Controlling Application

It is important to understand that the computer can contain many applications that can use the AJA device (as you switch from window to window) and it may not always be obvious which currently controls it.

Figure 17. Control Panel In Use Message (in red)

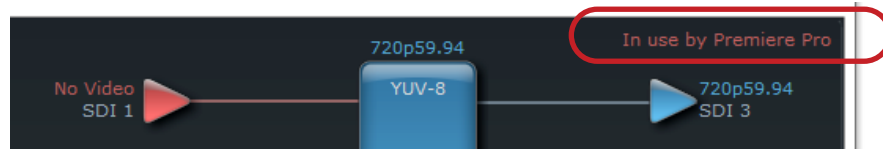

In the top right corner, the Control Panel displays the name of the application controlling the unit. In some cases, applications may not always properly “let go” of the I/O interface as another takes over—you’ll be able to tell by looking at the Control Panel.

Presets

Setups can be named and saved as a snapshot (Preset) for recall at any time. You can save various Control Panel configurations associated with your frequent tasks. You don’t have to spend time resetting interface configurations—just load the previously saved Preset for each task. If you work on multiple systems and want to carry your saved setup to another location, you can copy your saved Presets file on to movable storage and load it into any computer running the AJA Control Panel application. Presets are described in more detail later in this manual.

Single-User & Shared Preferences

When an AJA device starts up, preferences can determine what settings it will have it when it begins to operate. The AJA Control Panel offers preference settings that support both:

- User Preferences— Preferences stored from the last Control Panel State to be used on next startup of AJA Control Panel.
- Shared Preferences— Preferences saved by an Administrator for use as a default start state for AJA Control Panel.

User Preferences

This file exists to immediately, automatically, store preference changes made by a user on a particular AJA device. When any control is changed in the Control Panel, that change is recorded in the preferences file stored in a unique user preferences location dedicated to that particular device and serial number. Then, when AJA control panel is restarted for any reason, it will restart with the same preferences it used when it closed.

However, if a user sets their preferences, and then replaces the AJA device with a different one, the Control Panel will either:

- Start up with the factory defaults, or
- Start up with the “house defaults” dictated by the system administrator (if a Shared Preferences file exists).

The User Preferences file can be found in the following locations.

On Mac:

/Users/<USER_NAME>/Library/Preferences/com.aja.devicesettings

On Windows:

C:\Users\<USER_NAME>\AppData\Local\Aja\com.aja.devicesettings

Shared Preferences

An administrator can establish house standards for the AJA Control Panel by creating the user preferences file (described above) and placing it in a shared location where it will establish a standard default startup state for all users of a given computer system. These settings preempt the initial AJA default settings.

To establish the House Default for every user on every system, a system or network administrator can move this default file to all systems on the network (manually or by pushing it out across the network). All users on the network will then open to the House Defaults when they launch the AJA control panel for the first time.

NOTE: If the user makes changes to the control panel themselves, those changes will be saved in their user preferences, which will take priority over the house default dictated by the shared preferences file.

The Shared Preferences file should be a file created at the User Preferences location described above, and placed by the System Administrator in the following locations.

On Mac:

/Users/Shared/Library/Preferences/com.aja.devicesettings

On Windows:

C:\Users\All Users\Aja\com.aja.devicesettings

Function Screens

Listed below are the function screens for KONA and what they are used for.

Table 1. KONA Function Screens

Screen	Functions
Control	Configure some basic KONA operation options and output timing.
Format	Select the framebuffer primary video format and any secondary formats for conversion of inputs/outputs.
Input Select	View and edit input selections and audio mapping.
SDI Output	Select output format.
HDMI	Configure the HDMI I/O (not KONA 1).
HDMI HDR	(KONA 5 and KONA 4 in 4K Mode) Configure High Dynamic Range settings for HDMI output.
Analog Out	Configure the component format and audio monitor setup (not KONA 1, KONA 5).
Video Setup	Configure Video such as composite black level, progressive format and ancillary data (Closed Caption) option.
Audio Setup	Configures Audio options such as analog audio monitor level.
Audio Mixer	(KONA 5 and KONA 4 in 4K Mode) Select and mix audio sources for playback and capture.
Conversion	(Mac platform only) Select codec options such as whether paused video is full frame or single field, pulldown settings, and color space conversion.
DS Keyer	Setup and control the insertion of keyed video from the frame buffer or graphics files with alpha channel.
LUT	Load a lookup table (LUT) file to adjust the calibration of color for any source.
Timecode	Monitors SMPTE 12M-2 timecode and configure timecode window burn output.
Presets	Add or delete saved preset configurations (handy for quick and easy recall of different KONA settings for varied workflows).
Firmware	Install firmware from your currently installed AJA software package.
Info	Display status information and the firmware version number. This information is generally intended for troubleshooting/support.

About KONA Modal Operation

The KONA 4 and KONA 3G cards support modal operation. Functionality depends on what firmware has been installed on that card.

For KONA 4/3G you can choose to install either:

- Std Mode (KONA 3G) or UFC Mode (KONA 4)—for SD, HD, and 2K formats (allows up/down/cross-conversion).
- 4K Mode—for SD, HD, 2K and UltraHD (3840x2160) and 4K (4096x2160) formats (disables up/down/cross-conversion).

Most Std and UFC Mode functionality is also present in 4K Mode, with some exceptions. Refer to "[Control Panel Operation in 4K Mode](#)" on page 57 for information about these differences.

NOTE: KONA 5 and KONA 1 currently supports one firmware version.

Control Panel Operation in Standard or UFC Mode

Control Screen

Figure 18. AJA Control Panel, Control Screen

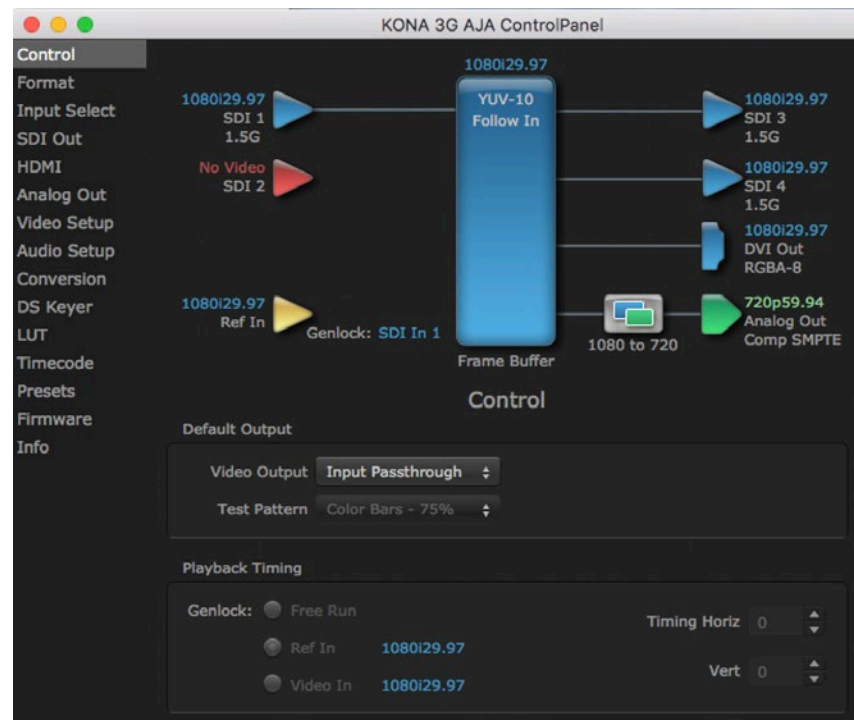

The KONA card can be controlled by various software applications running on a host computer. The Control screen is where you select how the KONA directs video and is used by application software. This screen also provides control for configuring output timing with regard to external reference video and horizontal/vertical delay. The top of the Control Screen shows the currently selected AJA device if more than one is available in your system.

Default Output

This is where you select what the KONA card will output as a default when no application has control of the board, such as when the Mac Finder or Windows Navigation Pane is active. Since KONA can be controlled by software applications as well as its own control panel, the output can change dynamically. When you select many video applications, they will take control of the KONA inputs and outputs. However, when an application that doesn't take control is active, these settings determine what KONA will output.

Input Passthrough

This selection directs KONA to route video from its selected input through the card for processing and output. When this selection is chosen, all Primary/Secondary Format selections are available for selection in controlling the output. This in effect makes the KONA card a converter. No applications other than the AJA Control Panel need be open to convert audio and video from one format to another. For example, if you have KONA 3G and need to dub an SD source tape needs to be HD, the signal can be routed from the SD VTR to the KONA card configured for up-conversion in the AJA Control Panel and then passed through to the HD VTR for recording.

Test Pattern

This selection directs the KONA card to output a choice of preset pattern when no other application is using the KONA card. You can choose from:

- Black, Color bars (75% or 100%), Ramp, Multiburst, Line Sweep, Multi Pattern, or Flat Field.

In addition to the preset test pattern choices, a “Load File...” selection at the bottom of the menu allows you to load any standard RGB graphics file (.tif,.psd, etc.) into the frame buffer for display.

While in Test Pattern mode, you can select RGB or YUV output via a pulldown menu.

NOTE: The graphic file will not be scaled to fit. If it's smaller than the current frame buffer format, KONA will center it in the frame. If it's larger than the current frame buffer format, it will be cropped on the right and bottom. Also some graphics formats and bit depths may not be supported. Once a graphic file is loaded into the frame buffer it will be retained until it is overwritten by another graphic or test pattern, or when power is turned off. Graphic file names are only “remembered” in the menu until the AJA Control Panel application closed.

Hold Last App

This selection directs KONA to hold and output the last frame of video from the last application to control KONA. This can be helpful when operating in an environment where you're switching back and forth between multiple application windows.

Playback Timing

Use these controls to set Genlock and Timing adjustment.

Genlock

Selects how KONA will synchronize program video:

- Freerun: In this mode, KONA generates sync without an external reference source
- Ref In: Directs KONA to use the Ref Video source for sync (usually an analog black burst video signal)
- Video In: Directs KONA to use whichever video input source has been selected in the Inputs Screen for sync

NOTE: For best results when capturing using Avid Media Composer or AJA Control Room, set Ref In to Video In with AJA KONA, AJA Io products and Avid DNxIV, DNxIP.

Timing (Horiz and Vert):

These two pull-downs allow output timing adjustment with reference to the Ref Video source selected:

- Horizontal selects a number of pixels (clocks) to offset
- Vertical specifies a number of lines to offset

Format Screen

Figure 19. AJA Control Panel, Format Screen

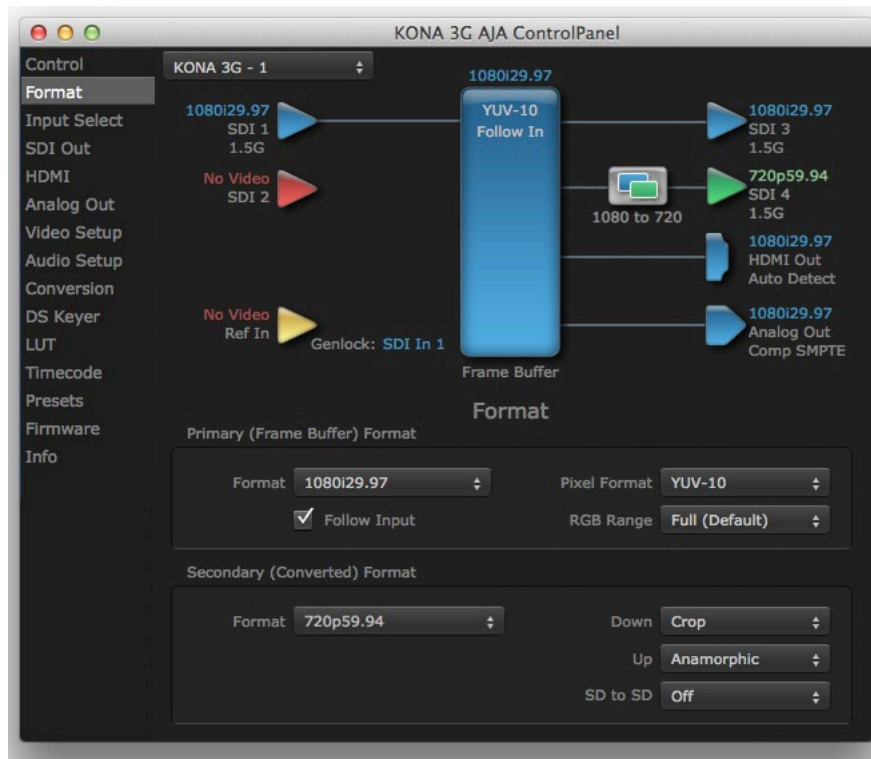

The Format Screen shows the video format currently in use by the KONA framebuffer (called the Primary Format) and allows you to change it. The KONA 4/3G Format Screen in Std or UHD mode also displays a Secondary Format for hardware conversion (not available on KONA 1).

IMPORTANT: Do not confuse this Format function screen conversion, which uses AJA hardware and operates on either Mac or PC, with the separate Conversion function screen, which uses QuickTime for conversion and is only available on Mac.

Video Format (Primary and Secondary)

These pull-down menus show the currently selected formats. If you select an alternate value in the Primary Format using the pull-down, it will change the format used by KONA's framebuffer.

When a change is made via the Video Format pull-down or by clicking an icon and selecting a new format via a contextual menu, the block diagram will change to reflect the new format. In the case of a Secondary Format, the formats available can vary based on what the Primary Format is and the input signal (frame rates of input sources limits the to/from conversion choices).

The "Secondary Video Format" pull-down menu lists all compatible formats for selection (incompatible formats are not shown). This allows you to see what you've chosen, and also see those formats that are compatible with the selected Primary format.

Pixel Format

Use this pulldown menu to choose: YUV-10, YUV-8, RGB-10, or ARGB-8 or RGB-12.

RGB Range

The RGB Range pulldown menu allows you to select either Full-range (0-1023) or SMPTE range (typically 64-940) for RGB color output.

NOTE: The AJA Control Panel software uses the abbreviation “sf” instead of “PsF” when referring to “progressive segmented frame” formats. In the manual and in other literature you may see either of these acronyms used interchangeably. Visually, it is easier to recognize:

- “sf” for progressively segmented frame formats
- “p” for progressive frame formats

Follow Input

Enabling the Follow Input checkbox allows the Control Panel Buffer to auto-switch to whatever is the detected input format. This feature works only if the controlling application supports input-based capture—AJA Control Room for example.

Format Conversions

NOTE: Video format conversions are not available on KONA 1.

Cross-Conversion

If you have an HD format as your primary and then select a secondary HD format with a different frame size, the KONA 4/3G will perform a cross-conversion where necessary (input or output) for “like Hz” formats. “Like Hz” means that 720P 59.94 may be converted to 1080i 29.97 (59.94Hz). Converting from disparate Hz is not supported on the KONA 4/3G for cross-conversions. The example below shows 1080i to 720p.

Up Conversion

The Up and Down pull-down menus are available when conversion has been selected for the video path to/from the framebuffer and like Hz formats are selected (the one exception is 1080PsF 23.98 which can be down-converted to 525i 29.97.) Different choices will be available depending on the type of conversion and formats being converted. SD to SD conversions are essentially aspect ratio conversions to accommodate transforming anamorphic images to letterbox or vice versa.

For up-conversion the following choices are available:

- Anamorphic: full-screen “stretched” image
- Pillar box 4:3: results in a 4:3 image in center of screen with black sidebars
- Zoom 14:9: results in a 4:3 image zoomed slightly to fill a 14:9 image with black sidebars
- Zoom Letterbox: results in image zoomed to fill full screen
- Zoom Wide: results in a combination of zoom and horizontal stretch to fill a 16:9 screen; this setting can introduce a small aspect ratio change

Down Conversion

For down-conversion the following choices are available:

- Letterbox: image is reduced with black top and bottom added to image area with the aspect ratio preserved
- Crop: image is cropped to fit new screen size
- Anamorphic: full-screen “stretched” image

Figure 20. AJA Control Panel, Format Screen (example cross-conversion)

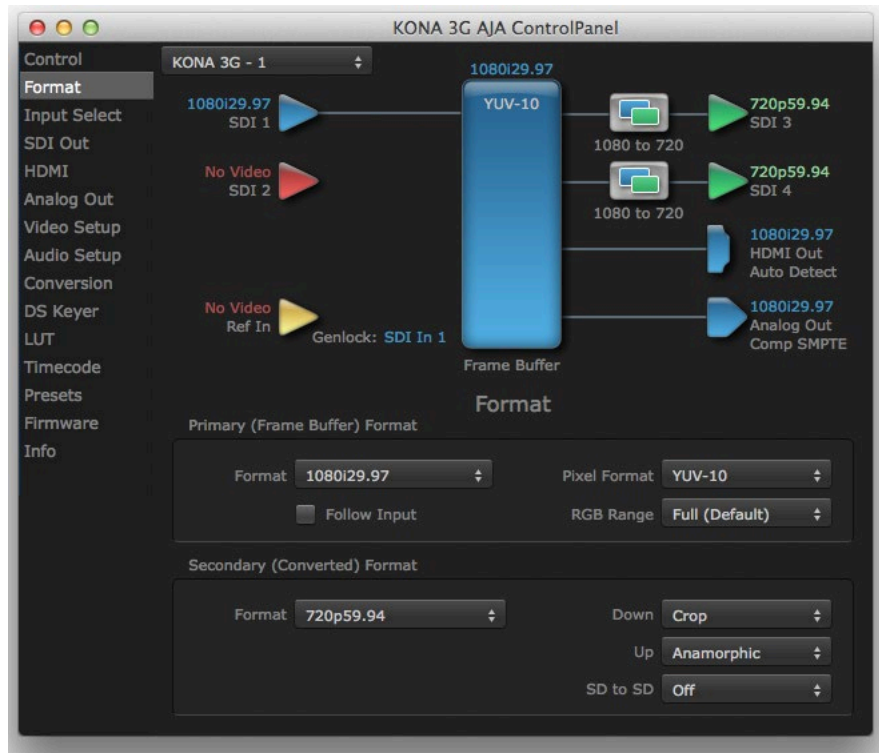

SD to SD

This pulldown is for SD to SD aspect ratio conversion.

- Letterbox: this transforms SD anamorphic material to a letterboxed image
- H Crop: will produce a horizontally stretched effect on the image; transforms anamorphic SD to full frame SD
- Pillarbox: will produce an image in the center of the screen with black borders on the left and right sides and an anamorphized image in the center
- V Crop: will transform SD letterbox material to an anamorphic image

Input Select Screen

Figure 21. AJA Control Panel, Input Select Screen



On the Input Select Screen, you can view the currently selected video and audio input sources and map audio sources to the channels supported by your editing application. Two information panes in the screen are provided: Video Input and Audio Input.

Video Input

Source

The pulldown menu allows you to see and change the currently selected video format that KONA has detected (if any). In the KONA 3G example shown above, video is selected at the SDI1 input and the format is 1080i with a frame rate of 29,97. Since this text is shown in blue, you can tell that it matches the framebuffer's primary format selected in the "Formats" screen. By looking at the input source, you can determine how the primary format should likely be set (unless you want to perform a conversion on the input). If you wish to select a different input, use the pulldown to select either SDI 1, 2, or Dual Link for two-wire 4:4:4 RGB, or Stereo 3D. For 3G single-link, choose the SDI Source used and select Stereo 3D from the SDI pulldown menu.

SDI

Select from YUV, RGB-SMPTE, RGB-Full, or Stereo 3D.

Audio Input

This pulldown menu allows you to pick where the audio comes from. KONA supports up to 8 channels of embedded audio. You can choose from the 16 channels embedded in the SDI, which 8 to bring in (1-8 or 9-16). Here, if only two channels were selected in the third-party application you are using, you can select which two channels from the eight embedded will be mapped to that application.

SDI Out Screen

Figure 22. AJA Control Panel, SDI Out Screen

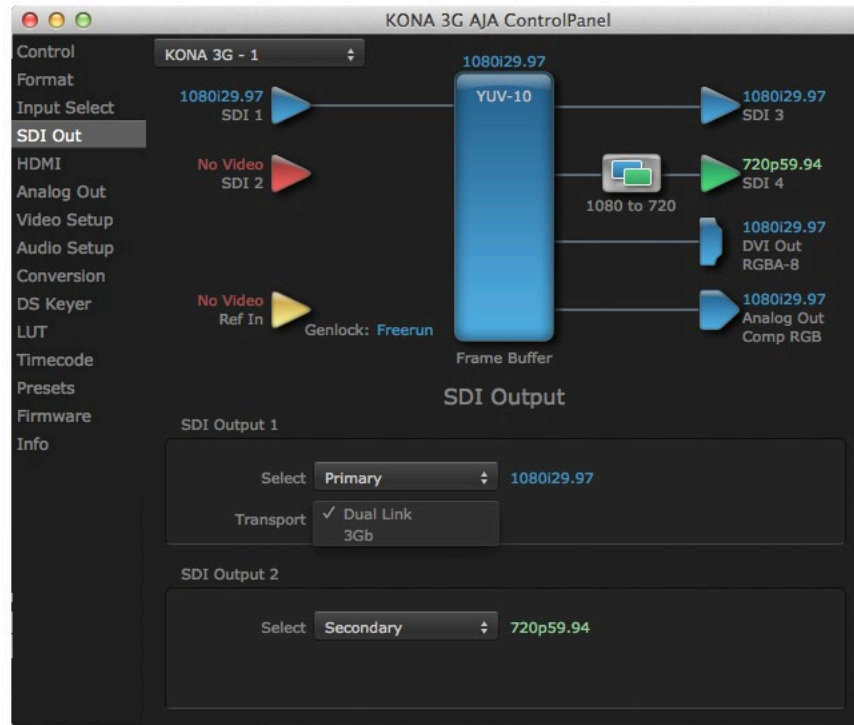

The SDI Out Screen shows the current settings for the SDI outputs.

- KONA 1 has one SDI output.
- KONA 4/3G has two SDI outputs.
- KONA 5 has up to four 3G-SDI output connectors able to carry a 4K/UltraHD signal, or a single connector can carry a 12G-SDI output.

Because the KONA 4/3G outputs can be configured independently, one output may be the Primary format and the other output may be the Secondary format. If an input/output has no video, it will be indicated on the block diagram (“No Video”).

Select SDI Output 1

Primary-YUV

When selected, this indicates that the SDI output is set to the same format as the framebuffer. That value will be listed in blue.

Secondary

When selected, this indicates that the SDI output is set to a format different from the framebuffer (Primary Format). That secondary format value will be listed in green. This shows that active processing of the video is taking place (format change and possibly up- or down-conversion).

RGB-SMPTE and RGB-Full

Selects RGB color output, an alternative to Primary-YUV above.

Video+Key

When selected, this indicates that the SDI 3 video is set to the same format as the framebuffer. SDI 4 is set to a video key signal associated with SDI 3 (the shape to be cut out from the video - this will appear as a black and white image/matte). Using the second KONA output as an Alpha Channel key, with the video output, may be useful for feeding production switchers, DVEs or other professional video equipment. If Video+Key has been selected as an output, the block diagram will indicate the SDI outputs with video in blue and the key in red.

Stereo

When selected, this indicates that SDI 1 represents the left eye output and SDI 2 represents the right eye output of stereoscopic material. KONA 4/3G also offers single link 3Gb output of multiplexed Stereo 3D.

Transport Options

- Dual Link - Output (SMPTE 372M) using dual-link transport.
- 3Gb - Output (SMPTE 424M) using a single-link transport.

Select SDI Output 2

Same as SDI Output 1, except no transport selection.

HDMI Screen

Figure 23. AJA Control Panel, HDMI Screen



Select HDMI Output

The Select pulldown menu allows you to select either the primary video format (framebuffer) or a secondary one (up/down/cross-conversion).

Stereo 3D

A pulldown menu for 3D output allows you to select either Side-by-Side or Top-Bottom (Stacked) output of left-eye and right-eye signals.

NOTE: This selection must agree with format selection in the third-party CineForm Codec (NOT included with AJA KONA 4/3G) pulldown menu.

Audio Ch

This pulldown allows you to select the number of embedded audio channels for the HDMI output. Two or eight channels can be chosen. Select from:

- 2 Ch 1-2 through 15-16
- 8 Ch 1-8
- 8 Ch 9-16

Protocol

The Protocol pulldown allows you to choose Auto Detect, HDMI or DVI protocol—use DVI if you're outputting to a DVI monitor using an HDMI to DVI adapter.

Color Space

Selects the HDMI output color space and depth. These are the choices:

- Auto—UDC automatically selects the mode based on getting the attached HDMI device's EDID information. This is the recommended setting. The selected mode is shown to the right of the pull-down control.
- RGB 8Bit—UDC uses 8-bit RGB mode regardless of the attached device's EDID.
- RGB 10Bit—UDC uses 10-bit RGB mode regardless of the attached device's EDID.
- YCbCr 10Bit—UDC uses 10-bit YCbCr mode regardless of the attached device's EDID.

RGB Range

The RGB Range pulldown menu allows you to select the type of RGB color output.

- SMPTE— (typically 64-940)
- Full—(0-1023)

Analog Out Screen

Figure 24. AJA Control Panel, Analog Out Screen

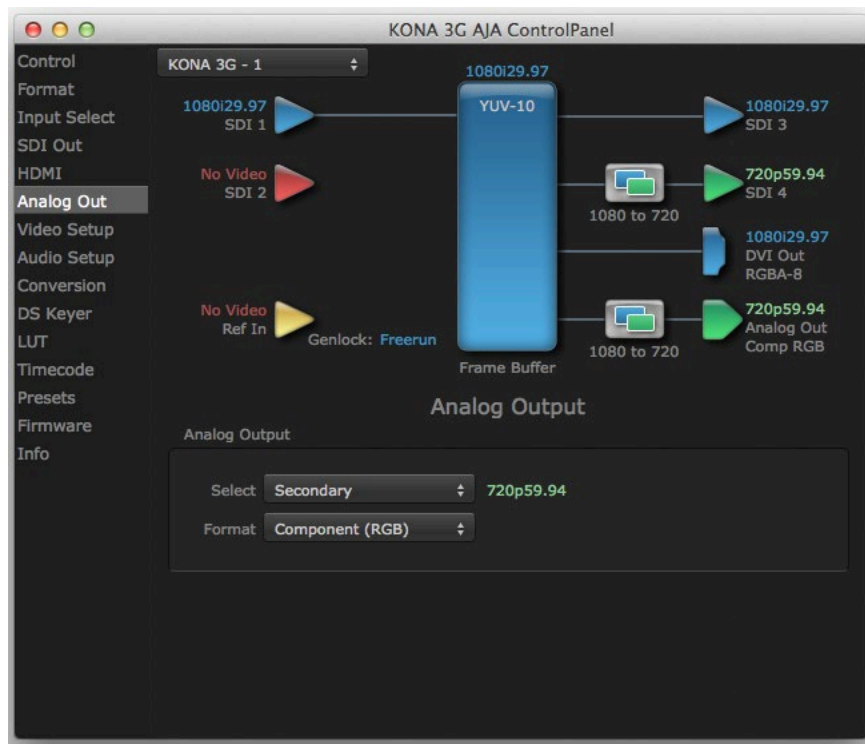

NOTE: This screen is not available on KONA 5 OR KONA 1.

KONA 4/3G provides a high-quality analog component or composite + Y/C output, generally used for monitoring. This screen shows the current settings for that analog output, and allows you to re-configure it when desired (format and black-level).

Select Analog Output

Select Primary or Secondary (any conversion applied) for the analog output; if a conversion is applied, you'll see the conversion icon appear on the block diagram.

Format

Select the video format from the Format pulldown.

- Composite + Y/C
- Component (SMPTE)
- Component (Beta)
- Component (RGB)

NOTE: Component Video, or YPbPr, has been given several names over time. YUV, Y/R-Y/B-Y, and YCbCr, are some examples. KONA uses the modern YPbPr terminology. The three different types of YPbPr (SMPTE/EBU N10, Betacam [NTSC], Betacam [NTSC Japan]) differ in level only.

Video Setup Screen

Figure 25. AJA Control Panel, Video Setup Screen

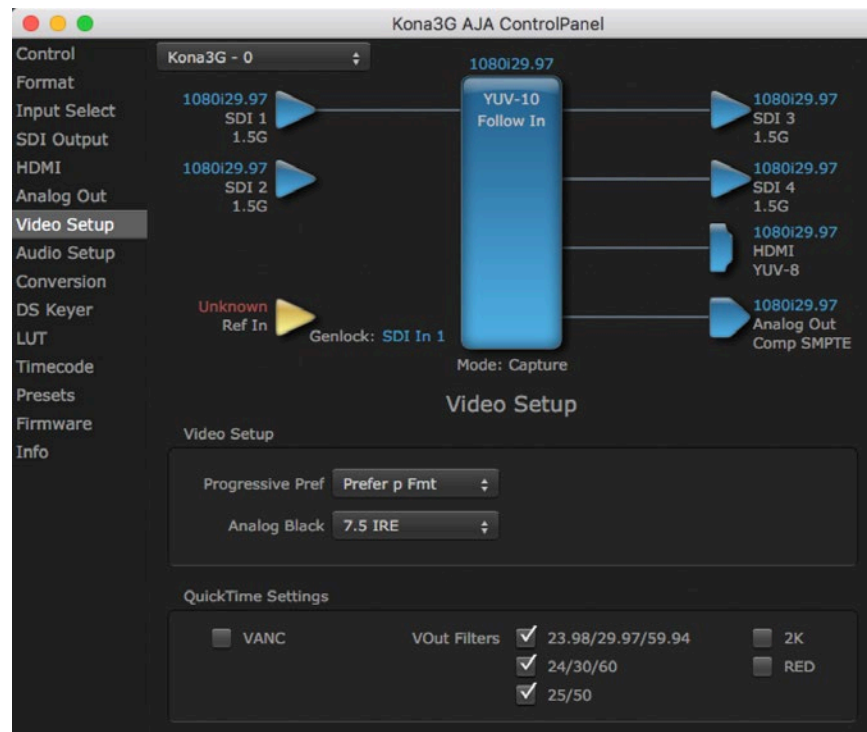

The Video Setup screen shows various other settings which will affect how video inputs and outputs behave, and how KONA interacts with some software applications.

Video Setup

Progressive Pref

Allows you to choose to prefer p (progressive frames) or PsF (progressive segmented frames) on non-interlaced output. This feature is used to default the hardware to use either p or PsF output over SDI when it has not been specified by the application.

Analog Black

Choices available for Black Level are the two Composite analog formats. Choices presented are for US or Japan:

- 7.5 IRE (NTSC US)
- 0 IRE (NTSC Japan)

SDI Input Quad Swap

- When checked (default setting is Off), changes the input Quad to SDI quadrant mapping from 1 to 1 to:
 - Quad1 - SDI3
 - Quad2 - SDI4
 - Quad3 - SDI1
 - Quad4 - SDI2.

SDI Output Quad Swap

- When checked (default setting is Off), changes the output Quad to SDI quadrant mapping from 1 to 1 to the mapping shown above.

Application Settings

VANC Checkbox

When checked ON, the VANC checkbox tells the KONA cards (previous to KONA 4) to capture and process any ancillary data in the SDI stream. This can include Closed Captioning data, and other types of metadata. Applications such as Premiere Pro and Final Cut Pro will not capture or output this data through the KONA, if this box is not checked on.

NOTE: KONA 4 does not require enabling the VANC checkbox for Closed Captioning.

VOut Filters

These controls enable/disable output capabilities in the QuickTime VOut filter. This filter is used by older applications that are built on legacy QuickTime architecture such as FCP7, AJA TV, VTR Exchange, and older versions of After Effects. Boxes that are checked will define what framerate and resolution types will appear in the list of available formats in the AJA hardware. For example, if 25/50 is unchecked, then all resolution/framerate combinations with 25 or 50 fps will not appear in the list of capabilities for the installed AJA hardware, when using software that relies on the QuickTime VOut filter.

Geometry Checkboxes

The 2K or RED checkbox needs to be enabled for that format to be presented and selectable in applications like AJA VTR Xchange and AJA TV.

Audio Setup Screen

Figure 26. AJA Control Panel, Audio Setup Screen, KONA 3G



The Audio Setup Screen shows the current settings for the analog audio output, allowing you to re-configure it when desired. Different screens are displayed depending on the KONA product.

Audio Monitor

Use the drop-down menu to select which two audio channels to monitor. Select from Ch 1-2 through Ch 15-16.

NOTE: This setting only applies to dual channel monitoring environments.

Figure 27. AJA Control Panel, Audio Setup Screen, KONA 4



In addition to the Audio Monitor control described above, KONA 4 has the following Audio Setup controls.

Analog Monitor Level

Allows adjustment of the analog monitor level, to match the audio to your operating levels. Select from:

- +24 dBu FSD
- +18 dBu FSD (default)
- +15 dBu FSD
- +12 dBu FSD

Audio Delay

(Not available for KONA 3G) Here you can set up to 6 frames (in tenths of a frame) of delay for KONA audio input and output. The AJA Control Panel delays all audio outputs—SDI, HDMI, and Analog.

IMPORTANT: If you use this Control Panel delay, do not use other delay settings in your applications. They can conflict.

Audio Mixer Screen

Figure 28. Audio Mixer Screen Example

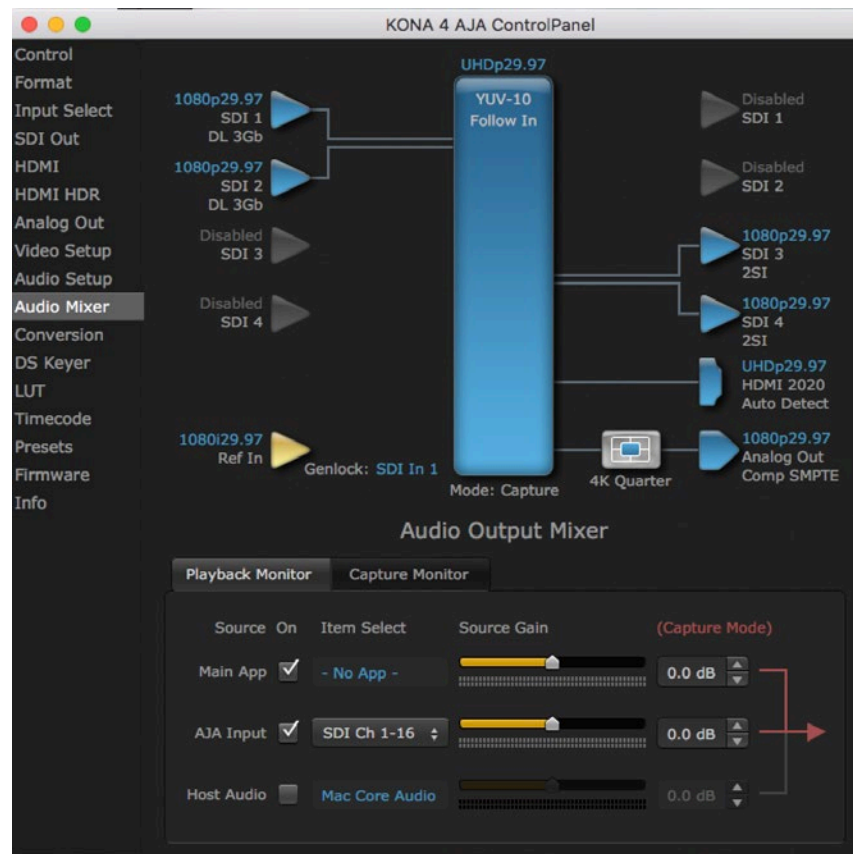

The Audio Mixer screen is available on KONA 1 and KONA 4/3G in 4K mode. See ["Audio Mixer Screens \(KONA 4 in 4K Mode and KONA 1\)"](#) on page 66 for specific information.

Conversion Screen (Mac OS only)

Figure 29. AJA Control Panel, Conversion Screen

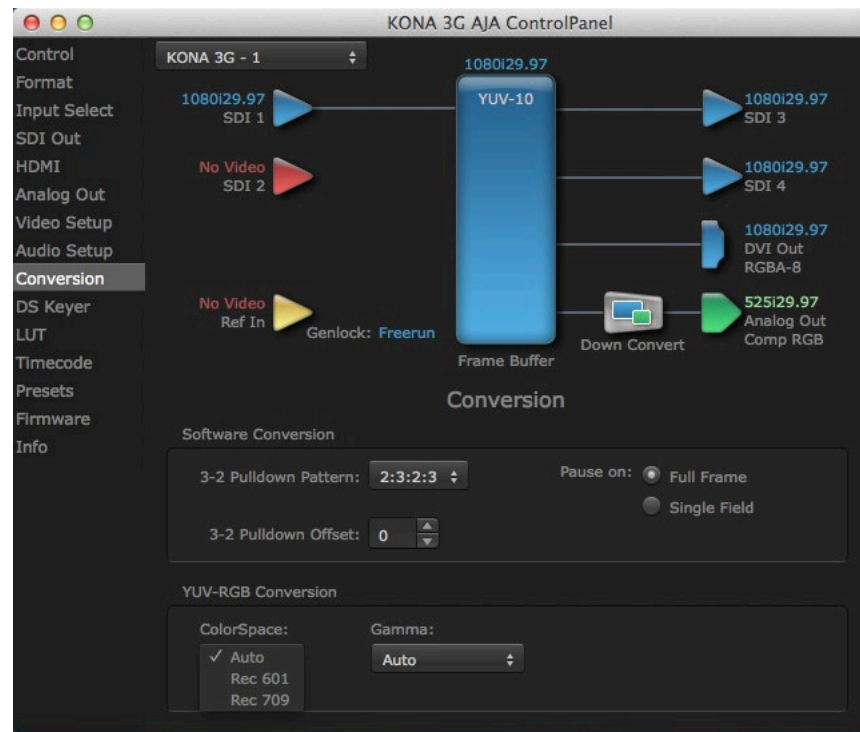

In the Mac OS version of the AJA Control Panel, this screen offers controls that determine how the card behaves with 3rd-party applications.

IMPORTANT: Do not confuse this Conversion function screen, which uses QuickTime for conversion and is only available on Mac, with the Format function screen which uses AJA hardware for conversion and operates on either Mac or PC.

Software Conversion

These parameters can affect pulldown and pause behavior. This group of software conversion parameters apply ONLY when using legacy QuickTime based applications on Mac OS. These applications include things like FCP7, VTR Exchange, and AJA TV. Applications like FCPX, Premiere Pro, Media Composer and Control Room, no longer use these legacy QuickTime Components.

3:2 Pulldown Pattern

The value selected from this list is used whenever, due to format selection, you've chosen to do 24 frames-per-second to 30 conversion where extra fields will be added to pad the existing ones. Depending on video content, selection of different field patterns may be useful in reducing jitter due to the content of adjacent fields. The numbers in the pattern choices specify the frequency with which inserted fields will be repeated. For example, "2:3:2:3" means duplicate a field twice, then the next field three times, then the next twice, and then back to three times.

3:2 Pulldown Offset

The 3-2 Pulldown offset is used if the 3-2 pulldown feature is removing the wrong frames. This setting lets you adjust when the pulldown begins in a sequence of frames.

Figure 30. AJA Control Panel, Codec Screen, Frame-padding Pattern Choices

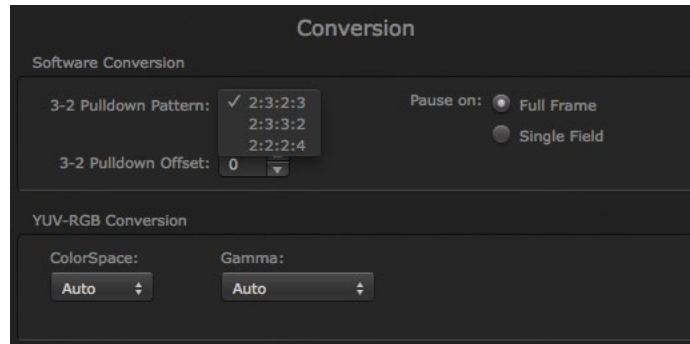

Pause On

These two choices determine what happens when the editing application is paused in stop mode:

- Full Frame: both fields are displayed resulting in some jitter while paused
- Single Field: a single field is displayed, showing no flicker (useful when color correcting or whenever the flickering would be a distraction).

YUV-RGB Conversion

These pulldowns select industry standard color space and gamma transfer functions for the YUV-RGB conversion, or allow you to direct the KONA card to automatically determine it for you.

Colorspace

Choose from:

- Rec 601
- Rec 709
- Auto

Gamma

Choose from the following:

- Linear (1.8)
- Rec 601 (2.20)
- Rec 709 (2.22)
- Auto

Downstream Keyer Screen

Figure 31. AJA Control Panel, DS Keyer Screen

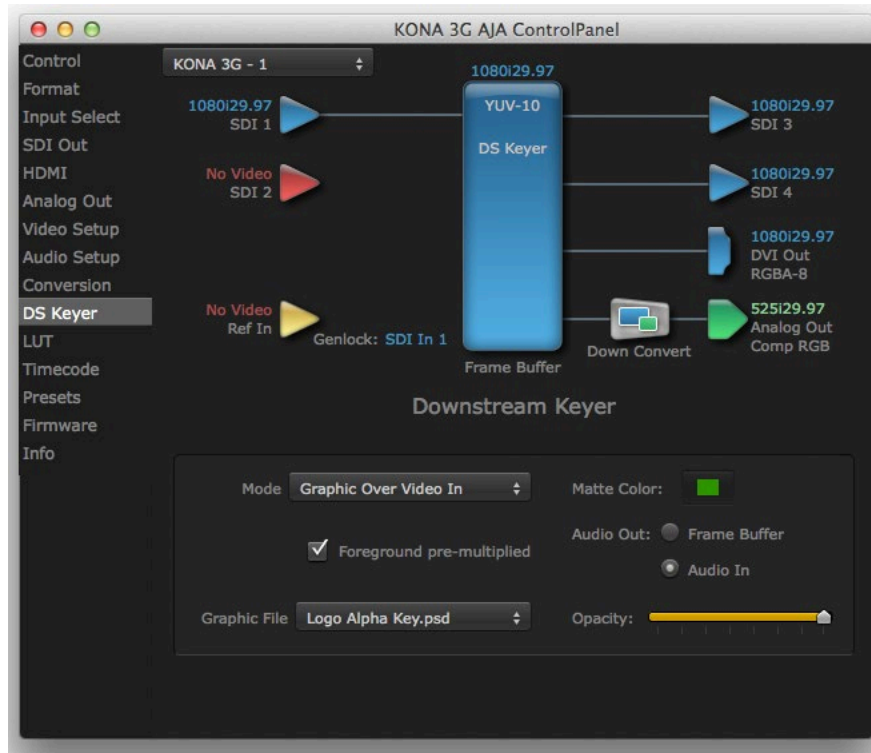

KONA 4/3G/IP have a hardware-based downstream keyer that is ideal for putting logos, “bugs” or other video material with an alpha channel on top of video being played out or printed to tape. A typical application would be putting a television station’s call letters or channel over program video content. Keyed video can be from the KONA’s internal Frame Buffer (from storage, video In, KONA TV, etc.) or from a graphics file that has an alpha channel (PhotoShop etc.).

Settings in the DS Keyer Screen provide control over how the keyer operates and whether it’s turned on or off. Controls and their meanings in the screen are as follows:

Downstream Keyer Mode

Downstream Keyer Off

When this pulldown menu item is selected the downstream keyer will be turned off.

Frame Buffer over Matte

Places the keyed video with alpha channel currently in the Frame Buffer over a fixed color matte determined by the “Matte Color” setting set separately.

Frame Buffer over Video In

Places the keyed video currently in the Frame Buffer over the video input for playback or print-to-tape.

Graphic over Matte

Places a graphics file having an alpha channel (chosen in “Graphic File” pulldown) over a fixed color matte determined by the “Matte Color” setting set separately.

Graphic over Video In

Places a graphics file having an alpha channel (chosen in “Graphic File” pulldown) over the video input for playout or print-to-tape.

Graphic over Frame Buffer

Places a graphics file having an alpha channel (chosen in “Graphic File” pulldown) over the current contents of the KONA card’s Frame Buffer (which might be from storage, video In, KONA TV, etc.).

Matte Color

Only available when the pulldown “Frame Buffer over Matte” or “Graphic over Matte” are selected—pressing this button brings up a color selection dialog. The dialog provides a variety of ways to select a matte color including a color wheel, color picker (choose from a location anywhere on the computer screen), numeric sliders, swatches, “crayons”, and spectrums. The matte chosen will be used as a video background under the keyed video.

Foreground pre-multiplied (checkbox)

Use to avoid “matte lines” and improve the appearance of the foreground (key) being composited over the background.

Audio Out

Frame Buffer

Select audio out to be routed from the contents of the Frame Buffer.

Audio In

Select audio out to be routed from KONA’s currently selected input(s).

Opacity

This slider controls the transparency of the keyed video (over the background) from translucent to completely opaque.

Graphic File Load

This pulldown allows you to choose from any recently accessed file or select a new file (“Load File...”), which then brings up a file dialogue. Remember that the file raster (pixel x pixel count) should match the primary format in the frame buffer or the secondary format if upconverting. Example: you wish to key a logo on top of your 1920x1080 footage, the still image with alpha channel that you load should be 1920x1080.

Figure 32. Downstream Keyer Graphic Selection

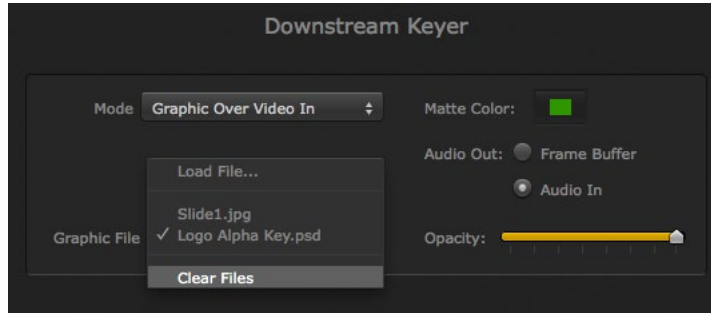

Figure 33. DS Keyer Screen, Loading a Graphic Over Framebuffer

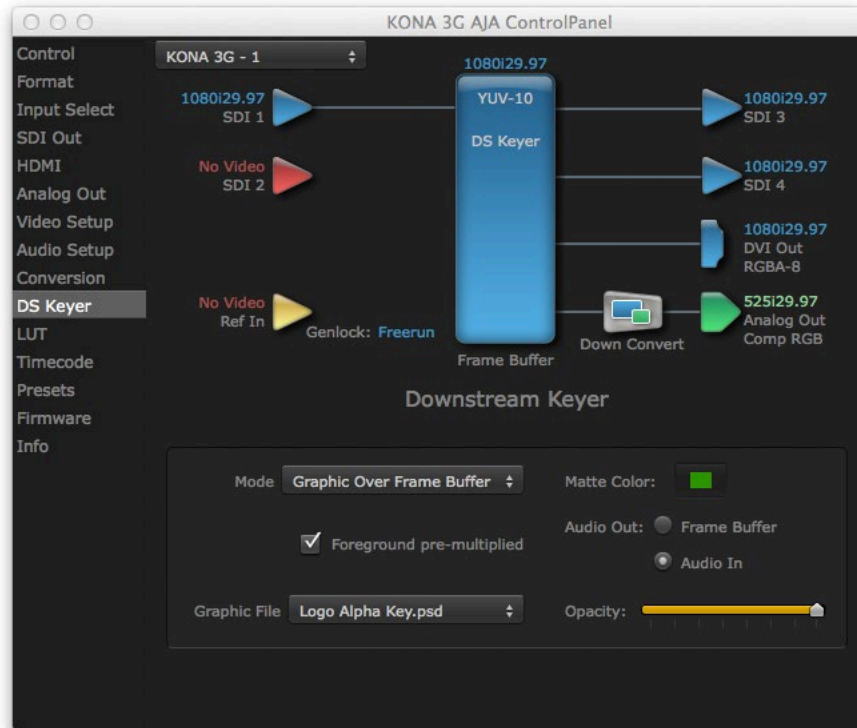
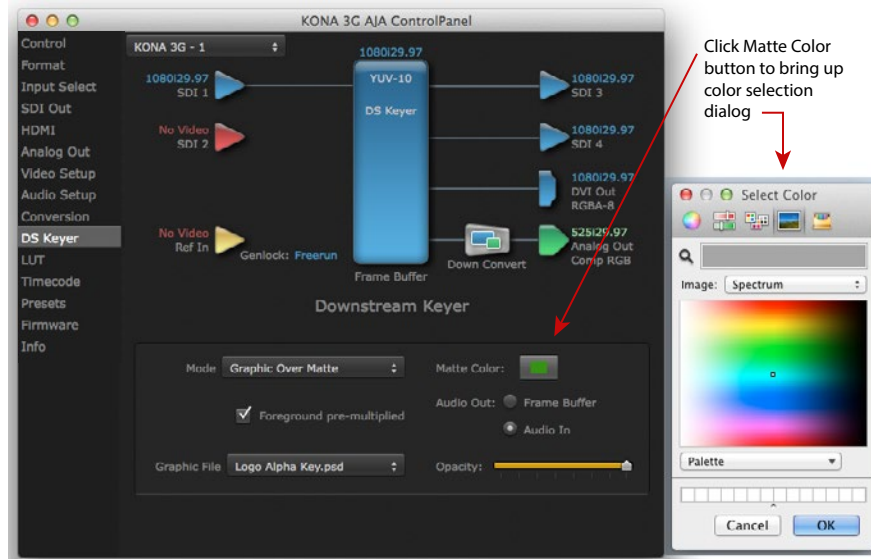
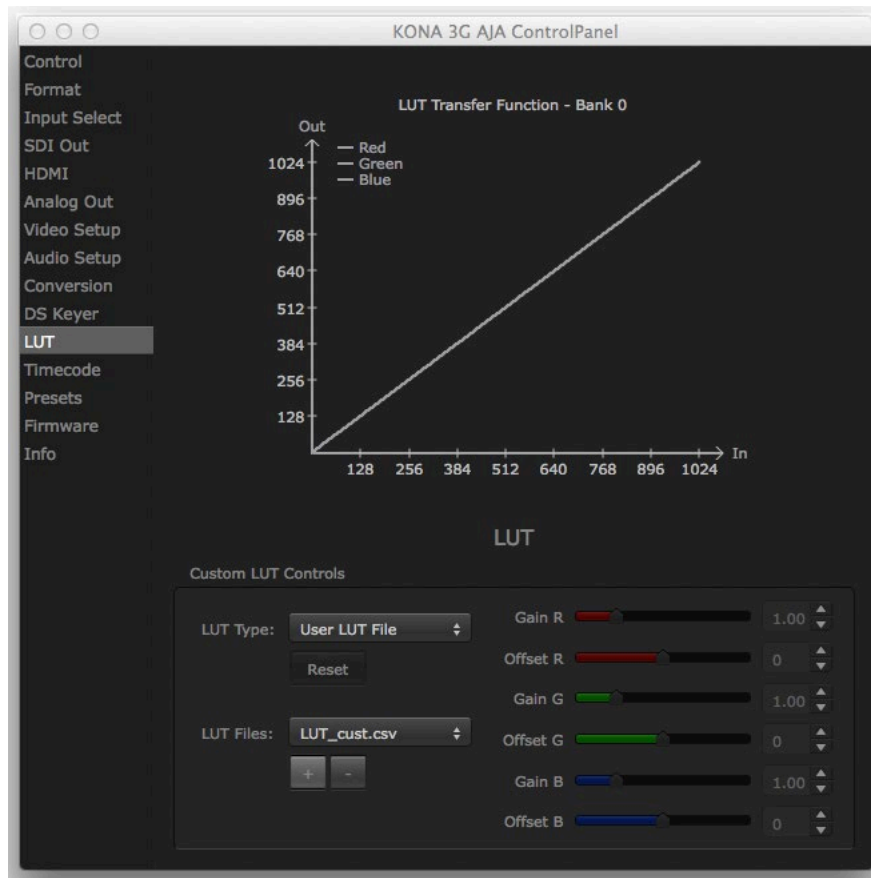

Figure 34. DS Keyer Screen, Loading a Graphic File Over a Matte



LUT Screen

Figure 35. AJA Control Panel, LUT Screen



The LUT screen controls allow you to create a custom color look up table (LUT) on the output, for matching a production "look" on a specific display.

Users can also specify their own custom LUTs by creating a LUT file and uploading it to an AJA Video Device using the LUT (lookup table) screen in the Control Panel.

Custom LUT Controls

The LUT Transfer Function screen displays an approximate representation of the effect of the current LUT settings. When the controls are activated by selecting a User LUT Type, Red, Blue, and Green curves show the transfer functions of each color.

NOTE: The displayed curves are approximate. Curves for some extreme settings may diverge significantly from the actual transfer functions.

LUT Type

Selects the type of LUT. Choose from

- Auto - LUT will be automatically selected. This setting intelligently applies the type of LUT required in the majority of use cases. For example, if the Frame Buffer is set to SD 608 and the Output set to HD 709, then an industry standard curve for changing 608 to 709 color space is applied.
- Linear - A linear 1:1 LUT is applied, resulting in no color change (every value for source is mapped to the same value for output).
- SMPTE-FullRange - A conversion LUT from SMPTE to Full Range is applied.
- FullRange-SMPTE - A conversion LUT from Full Range to SMPTE is applied.

- User Linear - Activates the Gain and Offset controls, allowing the manual creation of a custom LUT. Initial default setting is linear.

Figure 36. Example LUT Transfer Function Curves



- User Film Stream - Activates the Gain and Offset controls with a default curve matching Grass Valley FilmStream cameras, and also allowing manual creation of a custom LUT.
- User LUT File - See "[LUT Files](#)" below.

Gain and Offset Controls

When activated, the controls on the right allow adjustment of Gain and Offset for Red, Blue and Green.

- Sliders - The sliders on the right can be used to change the values for each color.
- Numeric Entry - You also enter a numeric value by clicking on the displayed number, and can increase or decrease the values clicking on the up/down arrow boxes.
- Cut and Paste - Right clicking on a displayed number opens a Cut, Copy, Paste dropdown menu for convenient numeric entry.

Reset

Clicking on the Reset button resets the currently selected LUT Type to its default values (not active for a User LUT file).

LUT Files

The User LUT File setting above activates the LUT Files dropdown, allowing the selection of a previously saved LUT file. You can create a custom LUT file using most text editors or spread sheets, provided the data is arranged according to the LUT File Format Specification that follows (see "[LUT File Format Specification](#)" on [page 53](#)).

Uploading Custom User LUT file

Once the LUT file is created, you can upload it with the following steps:

1. Before loading a LUT, make sure you are using an RGB/RGBA frame buffer format, and that you have a AJA Video Device that supports LUTs.
2. Open AJA Control Panel and select the "LUT" pane.
3. Click the "LUT Type" popup and choose "User LUT File" menu item. Note "LUT Files" options become enabled.
4. Click the "+" button and use the navigation dialog to choose a custom LUT file. The LUT is now loaded.

LUT File Format Specification

LUT files are normal text files that contain 1025 lines (numbered 0 - 1024). Each line contains 3 integer values in the range 0 - 1023, representing 10 bit R, G, B component output values. Component values may be separated by one or more commas, spaces, or tabs. The example below show LUT File contents for Line 0, Line 1, Line 2, and Line 1024, with several valid ways to separate the numbers in a line.

- 16, 17, 17
- 17 18 18
- 19 19 21
- ...
- 1000, 1022, 1023

In the example above, the first line (Line 0) represents the output values for the case where R=0, G=0, or B=0. In other words, if the R component of a pixel is set to 0, then set R component value to 16. Likewise, if G is set to 0, then set G to 17. The second line (Line 1) does a similar thing for input component values equal to 1.

A simple way to construct a LUT file is to use a Spreadsheet like Excel. Simply fill 3 columns and 1025 rows with LUT data, and save the result as a "CSV" file.

Timecode Screen

Figure 37. AJA Control Panel, Timecode Screen

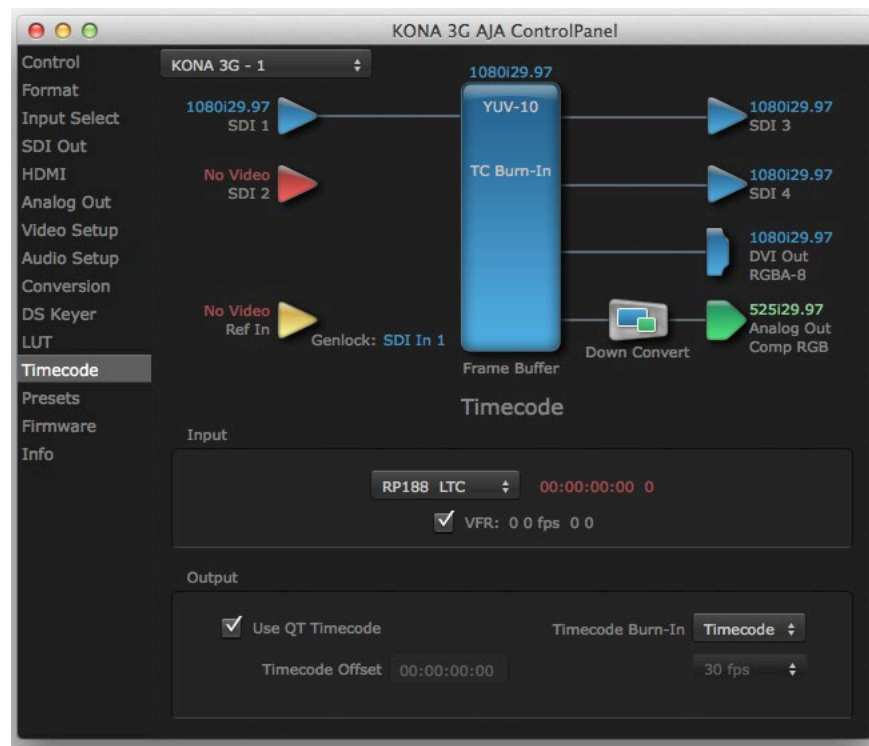

The Timecode Screen selects the timecode stream read for applications that use it (for example, when the timecode source is set to "Use control panel setting," AJA Control Room will read the selected stream). It is also used for monitoring the RP-188 timecode embedded in the digital data stream, and can be used for selecting a timecode offset (if required).

Timecode Input Settings

RP-188 Timecode <n>

In RP-188 timecode (SMPTE 12M-2) there can be multiple timecode types in the data stream. Use this pull-down to select the one you wish to monitor:

- RP188 LTC (Linear timecode)
- RP188 VITC 1 (Vertical Interval timecode)
- RP188 VITC 2
- LTC Port input

The selection will be displayed in the timecode value to the right of the pull-down.

User Bits

For monitoring a variable framerate (VFR) timecode (such as Varicam), you may wish to check the User-bits box. If you set this checkbox, KONA will detect and interpret the user-bits and display them next to the checkbox. You will see the original framerate (30 fps in the figure below) followed by the adjusted frame padding (two digits reporting discarded and retained frame padding).

NOTE: SMPTE 12M-2 is the updated name and specification for what was RP-188.

Timecode Output Settings

Use QT Timecode (Mac OS Only)

This feature is for Final Cut Pro 7 (or earlier), AJA Control Room, and AJA TV only. When checked, it directs KONA to output timecode from the QuickTime timecode track.

Timecode Burn-in

This pulldown selects whether the timecode value is displayed in a “burned-in” window in video output. If set to “OFF”, timecode will not be keyed over the video. If set to “Timecode”, then the timecode value will be keyed over the output video for all of the KONA outputs. This can be useful for synchronizing, choosing edit points, dailies, and many other purposes.

Timecode Offset (entry field and FPS pull-down)

When QuickTime timecode is disabled, this text entry field allows you to generate a timecode based on the offset entry. You can select a framerate from the pulldown menu at the right side of the pane. Use that same value here as the source video to ensure the timecode is synchronized.

NOTE: SMPTE RP 188 defines a standard for the transmission of time code and control code in the ancillary data space of a digital television data stream. Time code information is transmitted in the ancillary data space as defined in ANSI/SMPTE 291M. Multiple codes can be transmitted within a single digital video data stream. Other time information, such as real time clock, DTTR tape timer information, and other user-defined information, may also be carried in the ancillary time code packet instead of time code. The actual information transmitted through the interface is identified by the coding of a distributed binary bit. Equipment manufacturers can use the meta data for different purposes.

Presets Screen

Figure 38. AJA Control Panel, Presets Screen

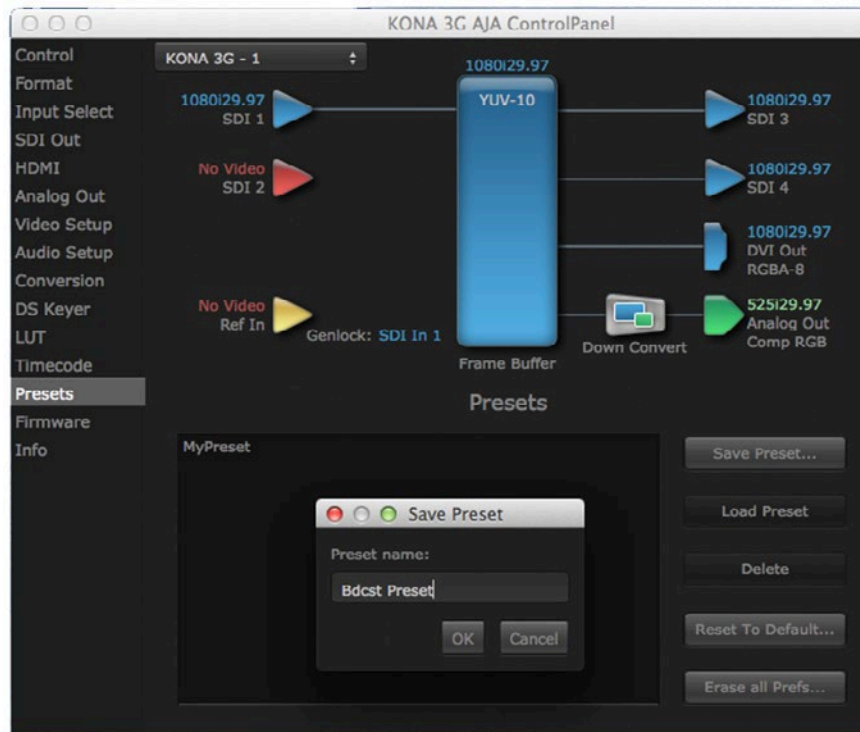

After configuring the AJA Control Panel screens, you can then save all your settings as a snapshot for later recall—called a preset. In this way, you can organize presets for all your typical tasks, eliminating time-robbing manual reconfiguration each time. To save a preset, go to the Presets screen and click “Save Preset.” A dialog will be presented asking you for a name; enter a meaningful name and click “OK”. Thereafter the preset will be available under the Control Panel “Presets” list.

From the Presets Screen you can manage your collection of presets easily. To Load or Delete a stored preset, just select it with your mouse and then click the “Load Preset” or “Delete” button respectively.

Transferring Saved Presets

If you want to use a saved Preset on another workstation, you can simply copy the file on removable storage and install it at the new location. The Preset file is always stored at:

- ~/Library/Application Support/AJA/<device name> Presets/ [on Mac]
- c:\Users\<username>\AppData\Local\AJA\Control Panel\<device name> Presets\ [Windows 8]

Reset to Default

When you click the ‘Reset to default’ button the control panel will delete the User’s preference file and do one of the following:

- If “Shared” preferences exist, they are reloaded and the device is set to this state.
- If the “Shared” preferences file does not exist, “factory defaults” are loaded and the device is set to this state.

Erase all Prefs

For technical support purposes you may be required to remove Preference settings. This button automates that function. If activated, all your preference setting will be lost.

For more information on Preset preferences see ["Single-User & Shared Preferences" on page 28.](#)

Firmware Screen

Figure 39. AJA Control Panel, Firmware Screen (Changeover to 4K)



Use the Firmware link to access the firmware update/changeover screen. For the KONA 4/3G, the Desired pulldown menu allows you to select either:

- Std Mode (KONA 3G)—for SD, HD, and 2K formats (allows up/down/cross-conversion).
- UFC Mode (KONA 4)—for SD, HD, and 2K formats (allows up/down/cross-conversion).
- 4K Mode—for SD, HD, 2K and UltraHD (3840x2160) and 4K (4096x2160) formats (disables up/down/cross-conversion)

Click **Install** to erase the current firmware and load the desired firmware.

You will be required to power-cycle your computer to finish the changeover.

See ["Firmware Update Procedure" on page 22](#) for details.

Info Screen

Figure 40. AJA Control Panel, Information Screen (Standard Mode)

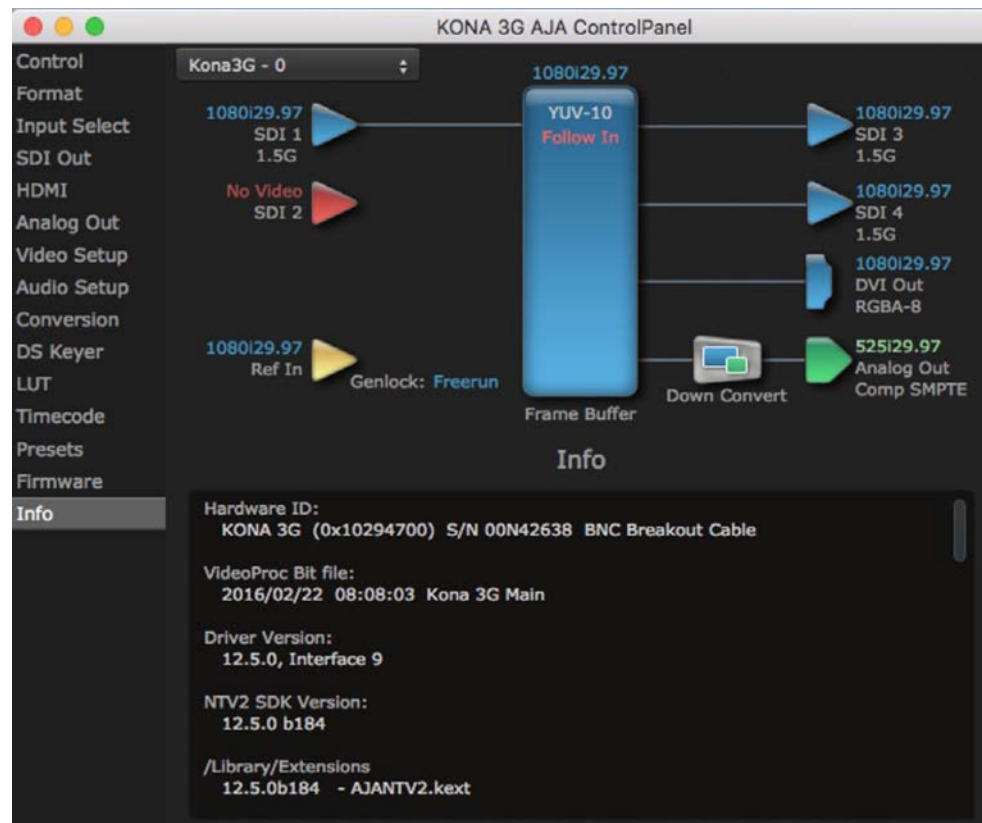

This screen shows the KONA software files that have been installed on your system. This information may be needed if you talk to an AJA Customer Service representative to determine if files are missing or need updating.

Control Panel Operation in 4K Mode

This section describes the AJA Control Panel operations specific to KONA 5, and available on KONA 4/3G models in 4K Mode. Note that in 4K Mode, you can still capture and playback SD, HD, and 2K formats, though there are no up/down/cross conversions available.

4K Transport Modes

The 4K and UltraHD SDI formats can use different transport modes, associated with the number of links used to transport the signal, the data rates involved, and the way the image data is organized. KONA 4K mode supports both Quadrant and Two Sample Interleave (2SI) transport standards. Many different combinations of modes and data organization exist. In 4K mode, besides single link transport SD, HD and 2K signals, KONA also supports the following transport modes for UltraHD and 4K:

- Quadrant 4-wire (transported on four links), available on KONA 4 and KONA 3G
- Quadrant 2-wire (transported on two links), available on KONA 4 and KONA 3G
- 2SI (two or four links automatically selected), available on KONA 4

The amount of data in the signal affects the number of links and data rates necessary to carry that signal.

Quadrant Mode

In Quadrant Mode (KONA4/3G), you can input (for capture) or output four channels of SDI HD 1080 or 2K video at 30 fps or less, representing individual quadrants of the higher definition UltraHD 3840x2160 or 4K 4096x2160 4K formats. Physical connections of the quadrants will be mapped to the SDI connectors as shown. Monitoring one of these HD signals on a standard SDI monitor will display one quadrant of the picture.

Figure 41. Mapping of Quad SDI Outputs



For UltraHD and 4K frame rates higher than 30, the same mechanism can be used to transport four 3G signals.

2SI Mode

Two Sample Interleave is an alternative method to organize the data of SDI UltraHD and 4K formats. Instead of dividing the picture raster into quadrants, this method samples pixels to create four lower resolution versions of the entire picture. These are combined later to create the full resolution image.

Figure 42. Mapping of 2SI Outputs



For 2SI UltraHD or 4K SDI video at 30 fps or less, monitoring one of these four signals on a standard SDI monitor displays the entire picture, but at a lower resolution. Above 30 fps, 3G bandwidth is required, so this type of signal cannot be monitored on a standard SDI monitor using only one connector.

NOTE: In some versions of AJA Control Panel, the 2SI method is referred to as '425' which is a reference to the SMPTE 425 standard which defines this method.

2-Wire and 4-Wire Modes

Using higher data rates, it is possible to carry UltraHD and 4K signals on two SDI links, instead of four. In this situation, half (two quarters) of the image data is carried on one link, with the other half carried on the other link. These types of signals also cannot be viewed on a standard SDI monitor using one connector.

You can choose 2-wire or 4-wire input and output (depending on the type of signal). If the number of links selected is not sufficient, the number of links is automatically increased to accommodate the signal. UltraHD or 4K SDI signals 30 fps and below can be input and output simultaneously, using two connectors in

each direction. However, all four connectors are required above 30 fps. You will be able to either input or output a high frame rate SDI signal, not both at the same time. In this situation, you can use the HDMI output or a down-converted Analog output to monitor the input signal.

Specifying the number of wires for output forces Quadrant mode. You cannot specify the number of links when 2SI output is selected (the lowest number of links will be set automatically).

Control Screen in 4K Mode

Figure 43. AJA Control Panel, Control Screen with UltraHD 4 Link Input

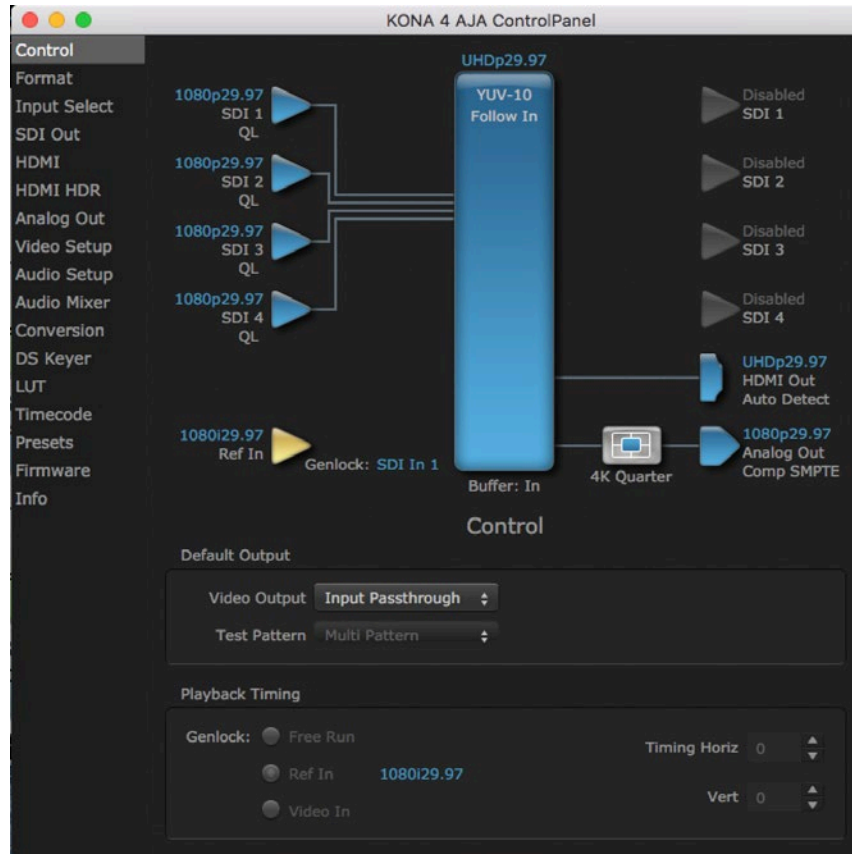

Besides SD and HD input and output, 4K mode permits UltraHD or 4K input and/or output over 2 or 4 links.

For example, setting the Control Screen Default Video Output to Input Passthrough with a UltraHD 29.97 four link input connected, and selecting UltraHD/4K 4-wire Source on the Input Select menu, four connectors are used receive the signal to process. UltraHD signals report their links as 1080. No SDI BNC output connectors are available for use.

If a 4K 29.97 two link input is connected and a UltraHD/4K 24-wire Source is selected on the Input Select menu, two BNC connectors are used for input, allowing the other two to be used for SD output. 4K signals report their links as 2K.

Figure 44. Control Screen with 4K 2 Link Input and Output

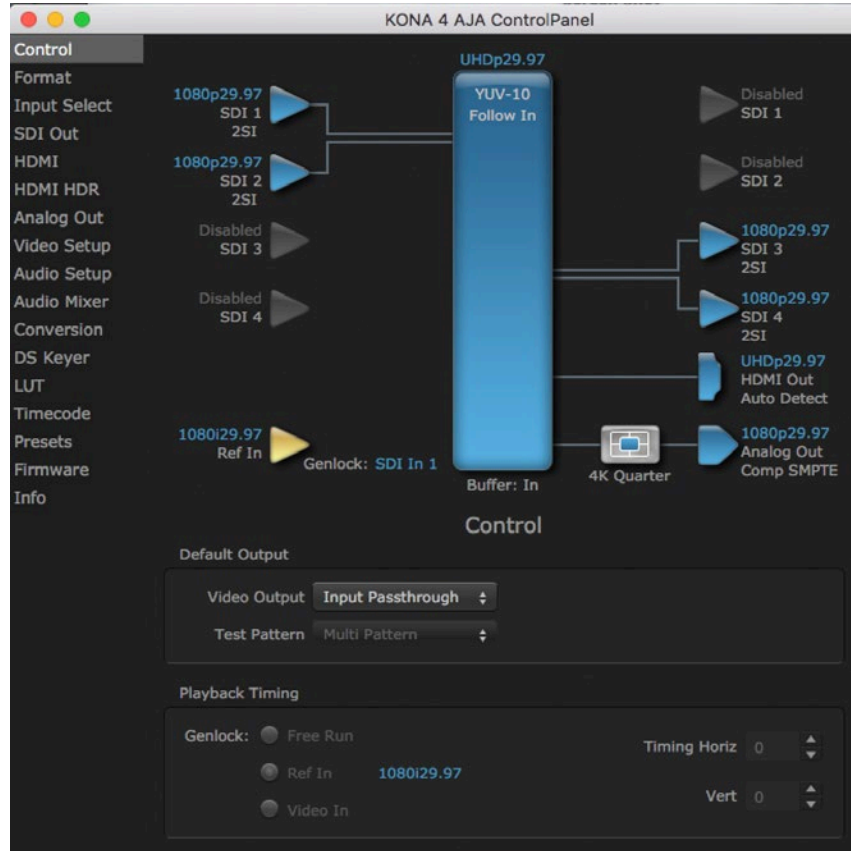

4K Controlled Mode

Alternatively, if you launch an appropriate control application (such as AJA Control Room), the SDI input and output ports will be mapped automatically. If you connect a UltraHD or 4K input signal higher than 30 fps, all four BNCs are required for SDI input or output. You can use the HDMI output to monitor an input signal.

Figure 45. Control Screen with a Controlling Application

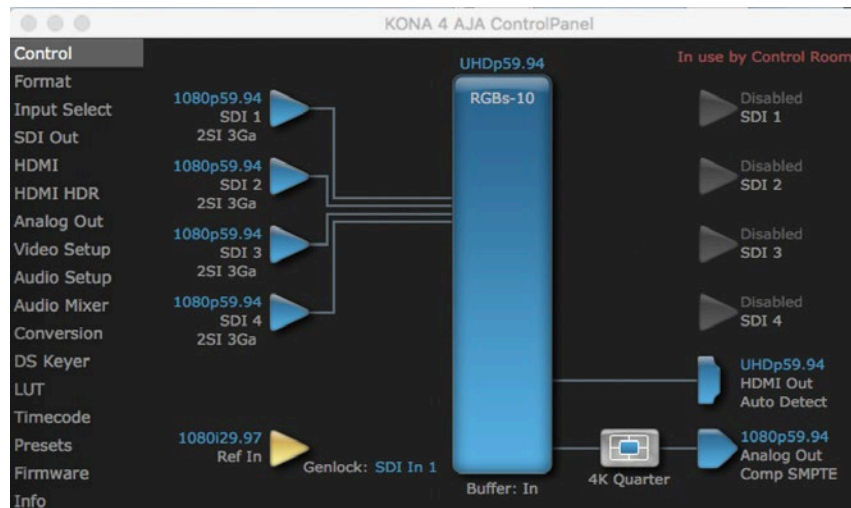

SDI Out Screen in 4K Mode

Figure 46. SDI Out Screen with 4K Format

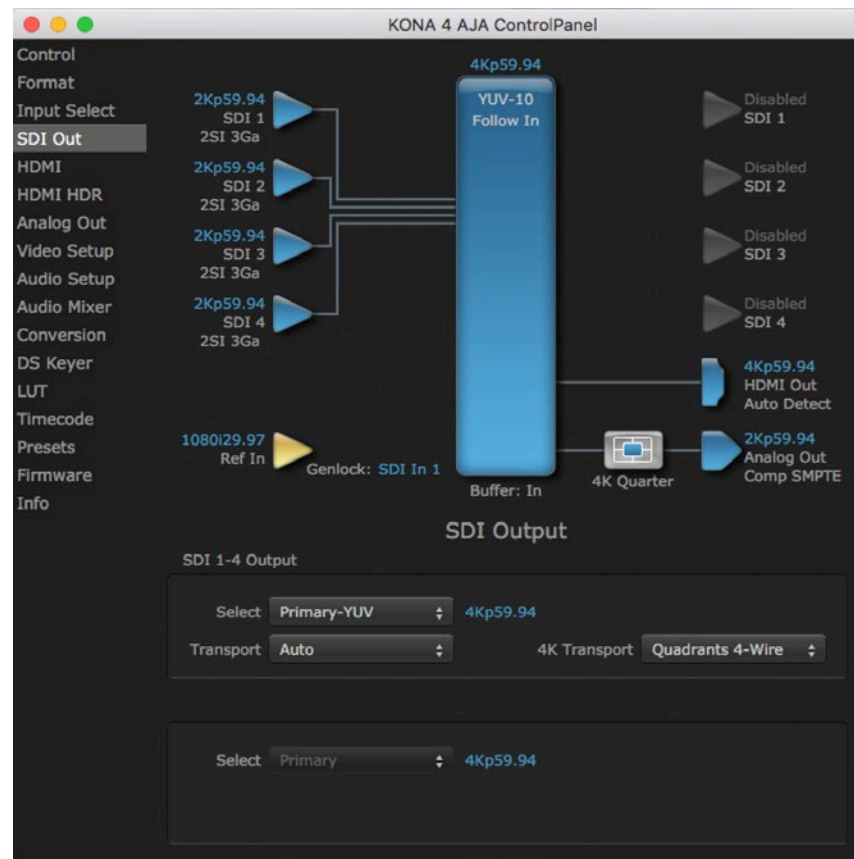

The SDI Out Screen allows you to select the Primary format or RGB for 4K output, same as Std or UFC Mode. Video+Key and Stereo 3D are only available for SD, HD, or 2K formats.

Additional 4K related settings are available in 4K mode.

Transport

Select from:

- Auto - Set automatically based on input.
- Dual Link - Output (SMPTE 372M) using SDI 1 and SDI 1 in concert.
- 3Gb - Output (SMPTE 424M) using a single-link transport.

4K Transport

Select from:

- Quadrants 4-Wire
- Quadrants 2-Wire
- 2SI (Two Sample Interleave)
- 4K Quarter 1-Wire - Real-time playback downconversion to HD on the SDI 3 output.

NOTE: The 4K Transport setting also affects the KONA HDMI output signal, even if the SDI inputs are not being used. A SMPTE 2Si setting is required for UltraHD/4K HDMI output. Other 4K Transport settings will downconvert HDMI output to HD or 2K.

HDMI Screen in 4K Mode

Figure 47. AJA Control Panel, HDMI Screen with Quad HD Output



The HDMI screen allows you to make the same selections previously described for when an SD, HD, or 2K format is selected (refer to ["HDMI Screen" on page 39](#)), except a Secondary format cannot be selected.

Select

For UltraHD/4K formats, this pulldown lets you choose:

- Primary – the full 4K or UltraHD format
- 4K Quarter - Down converts 4K to 2K, and UltraHD to HD.

NOTE: The 4K Transport setting on the SDI Out screen also affects the KONA HDMI output signal, even if the SDI inputs are not being used. A SMPTE 2Si setting is required for UltraHD/4K HDMI output. Other 4K Transport settings will downconvert HDMI output to HD or 2K.

HDMI HDR Screen (KONA 4 in 4K Mode)

Figure 48. HDMI HDR Screen with 4K Primary Format

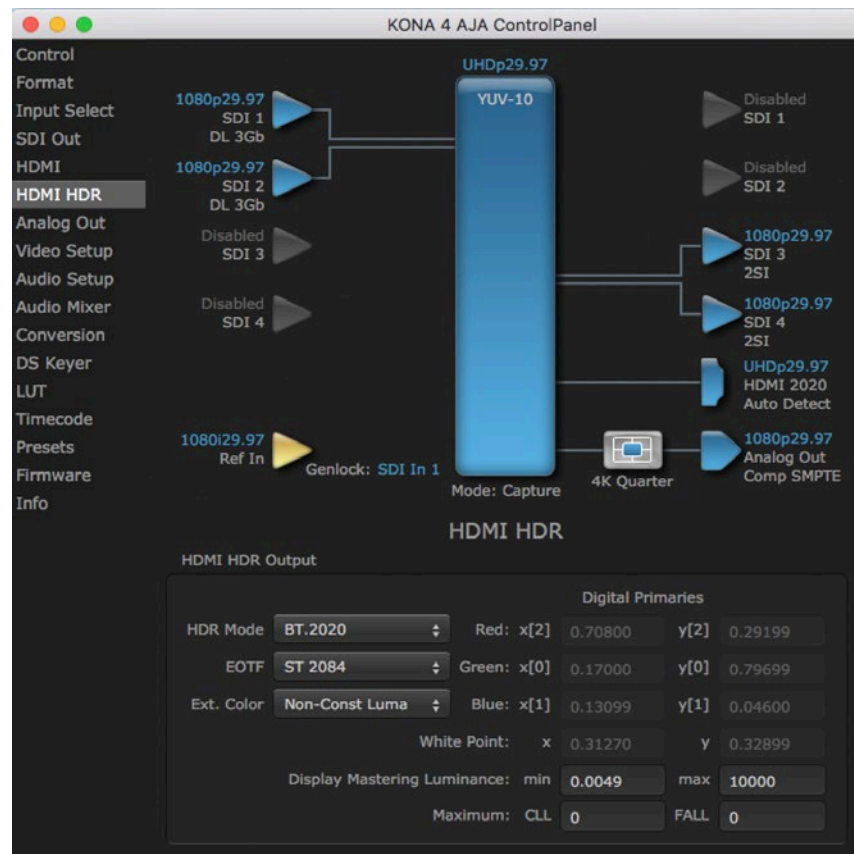

The HDMI-HDR screen, available in the 4K mode of KONA4/3G, provides a mechanism to inform an HDMI display device (such as a TV or monitor) that the video content is HDR. This includes generation of the Dynamic Range and Mastering Infoframe and the static metadata descriptors as defined in CTA-861.3 and HDMI v2.0a. Included are pre-defined primaries values for BT.2020 and DCI P3 color gamuts.

HDR Mode

- Off - HDR Mode disabled (default).
- DCI-P3 D65 - Only Display Mastering Luminance available for Digital Primaries.
- BT.2020 - Typically used with HDR.
- Custom - Allows custom values for the Digital Primaries.

EOTF

The Electrical Optical Transfer Function metadata bit tells the HDMI display which EOTF to use. Most TV's will require this to be set to ST 2084 for their HDR modes.

- Trad Gamma SD
- Trad Gamma HD
- ST 2084 (HDR-10)
- HLG (Hybrid Log Gamma) - No meta-data for Digital Primaries.

Ext. Color

Most TV's require this be set to Non-Const Luma to go into their HDR modes.

Digital Primaries

Selecting Custom HDR Mode allows the editing of digital primaries information that is passed as metadata accompanying the video signal. However, when HLG selected as the EOTF digital primaries information cannot be edited, because HLG does not use metadata.

Display Mastering Luminance

Represents the minimum and maximum Display Mastering Luminance.

- **Minimum:** Defines the floor of the SMPTE ST 2086 color volume (in the case of HDR) and is determined by the mastering environment.
 - Range: 0.0000 cd/m² to 1.0000 cd/m².
 - Step size: 0.0002 cd/m².
- **Maximum:** Defines the ceiling of the SMPTE ST 2086 color volume (in the case of HDR) and is determined by the mastering environment.
 - Range: 1 cd/m² to 65535 cd/m².
 - Step size: 1 cd/m².

Maximum Content Light Level (CLL)

Represents the highest-value pixel component in an entire scene. It is determined by analyzing each frame of video, and can be determined in the post environment.

- Range: 1 cd/m² to 65535 cd/m².
- Step size: 1 cd/m².

Maximum Frame Average Light Level (FALL)

Represents the maximum of frame-based average light levels taken over an entire scene, and can be determined in the post environment.

- Range: 1 cd/m² to 65535 cd/m².
- Step size: 1 cd/m².

Analog Out Screen in 4K Mode

Figure 49. AJA Control Panel, Analog Out Screen with 4K Primary Format

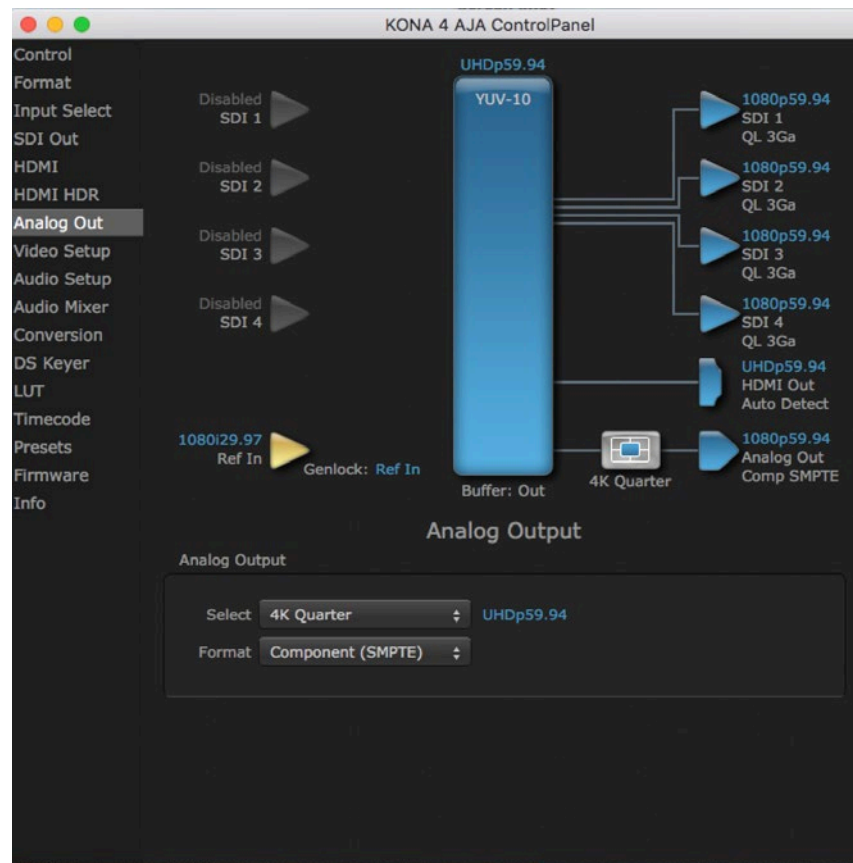

The Analog Out screen allows you to make the same selections previously described for Standard Mode when an SD, HD, or 2K format is selected (refer to ["Analog Out Screen" on page 40](#)).

For UltraHD/4K formats, an Analog Output Select menu is available to choose:

- 4K Quarter – (KONA 4) a downconversion to 2K x 1080 in 4K or 1920 x 1080 for UltraHD.
- Quadrant 1, 2, 3, or 4 of the 4K or UltraHD signal (see the discussion on 4K quadrant mapping at the beginning of this section).

Video Setup Screen in 4K Mode

Figure 50. AJA Control Panel, Video Setup Screen (4K checkbox)

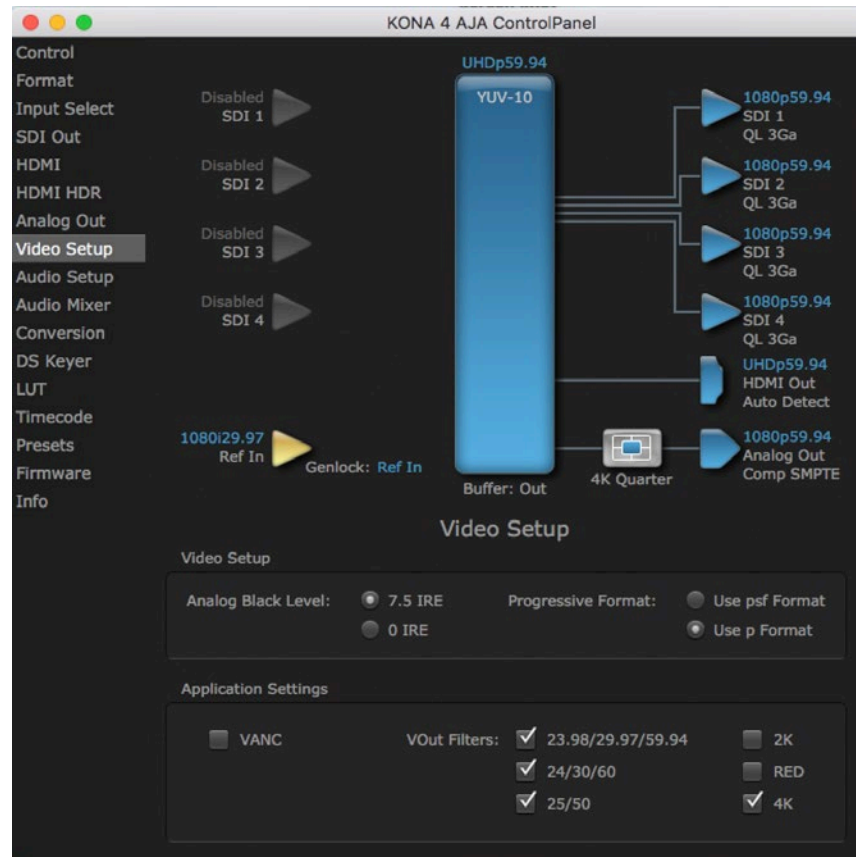

4K Mode adds the 4K Geometry selection (checkbox). Like other raster sizes, the Geometries checkbox for 4K needs to be enabled for the format to be presented and selectable in applications like AJA VTR Xchange and AJA TV.

Audio Mixer Screens (KONA 4 in 4K Mode and KONA 1)

The Audio Mixer screen has two tabs; Playback and Capture. These tabs display what sources are available for monitoring / mixing via the AJA hardware when in either of those two modes (if applicable). The controls on this screen are dedicated only to monitoring adjustments, and do not affect the level at which inbound audio signals are captured to storage.

The selection check boxes and screen slider controls affect the following KONA outputs:

- SDI Embedded Audio Out
- HDMI Embedded Audio Out.

IMPORTANT: *Even though you can hear changes in the signals and levels adjusted with the Audio Mixer screen, these changes are NOT recorded to disk during NLE Capture or Audio Punch In / Voice Over to Timeline. In addition, muting or activating sources on this screen will not affect audio signals being recorded. The Audio Mixer screen is dedicated for monitoring only, not program mixing.*

The branching arrow on the lower right indicates which sources are being routed for monitoring in that operating mode, and is colored blue when active and red when disabled.

Figure 51. Audio Mixer Screen Example

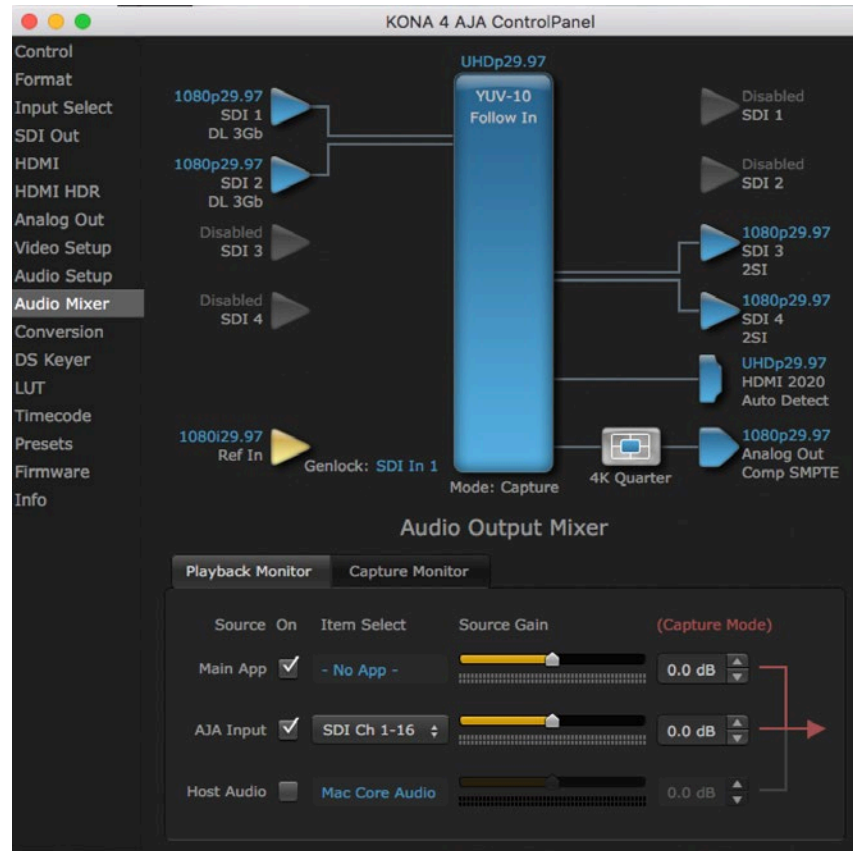

Each source has a confidence meter, which enables you to tell immediately if you have a source arriving correctly at the AJA hardware (without having to launch any other software). The level sliders allow a simple plus or minus adjustment to the Source level being monitored. This is to allow for fine-tuning of your listening environment (on occasions the host system audio can be unexpectedly loud, or an incoming feed may be very loud or very quiet).

Two different Audio Mixer screens are available, selected by clicking on the Playback Monitor or Capture Monitor tabs. During regular editing, the Playback tab is used to control your monitoring experience. During capture operations, the Capture tab is used for your monitoring experience.

Controls in each tab are only in effect when KONA is in the correct operating mode, as determined by the controlling application or the Control Panel application's Default Output setting. When the mode doesn't match, the mode indicator on the right goes red (see [Figure 51](#)). However, settings can be adjusted while in that disabled mode, and will be applied when you return to that operating mode.

Audio Mixer Playback Monitor Mode Screen

Figure 52. Audio Mixer Screen, Playback Monitor Mode

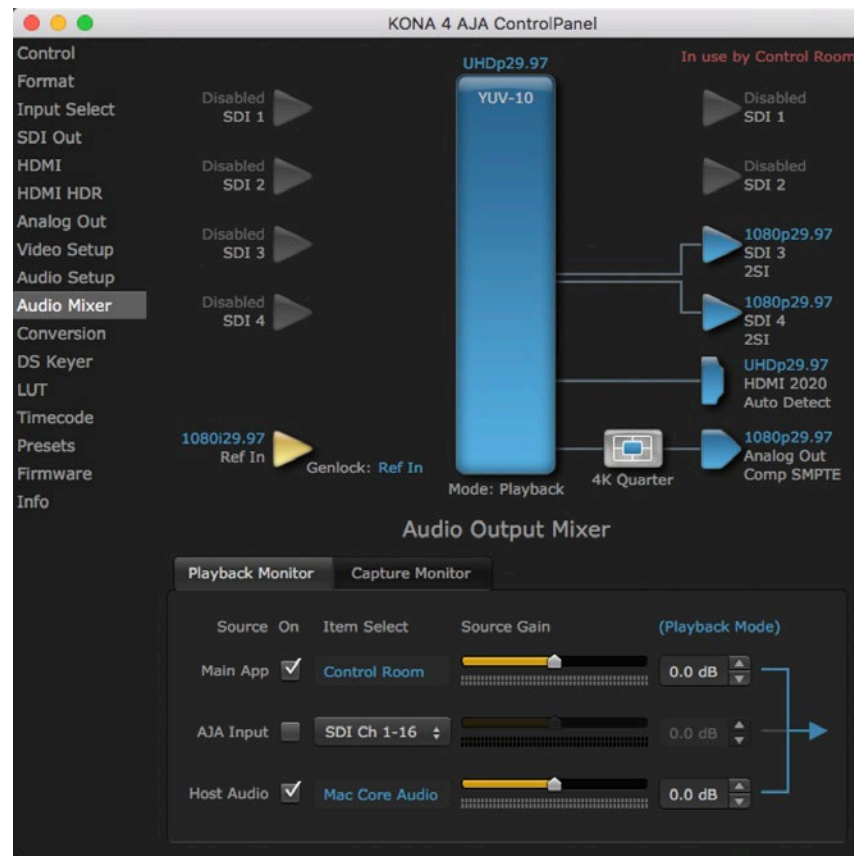

Playback Source Selection

Clicking the **On** checkbox selects the audio for that item for playback to the audio monitor outputs. Multiple sources can be selected simultaneously.

Main App

If an external application is controlling the KONA, it will be displayed in the **Item Select** column and its audio can be selected for playback with the checkbox.

AJA Input

Selects for monitoring the audio being input to KONA.

NOTE: The AJA Input Item Select dropdown selection is linked to the Input Select screen's Audio Input Select dropdown. Changing the setting on one screen will also change the setting on the other screen.

In the **Item Select** column, click on the dropdown and choose from:

- Auto - Automatically selects audio as detected.
- AES/EBU - Digital audio being received on the breakout cable BNCs or breakout box (not KONA 1).
- SDI Ch 1-16 - The embedded audio being received on the KONA SDI In connectors.

Host Audio

Selects the audio from the host computer, thus enabling the AJA hardware to monitor anything that would normally be presented via the host laptop, CPU or computer monitor. For example, an editor could sample music from an online library, while concurrently playing back their NLE timeline. Or, a producer and editor could be communicating live during an editing session, using Skype or some other video calling tool.

Source Gain

Meters display the input audio levels of the source, colored green when that source is On, and gray when that source is not selected. The levels shown do not change when the gain is adjusted, because the input levels are being monitored, not the output levels.

When activated, the source gain controls can be used to adjust the monitoring output gain of that source, from +6dB to - infinity (mute). Adjustment methods include:

- Sliders - The sliders on the right can be used to change the values for each color.
- Numeric Entry - You also enter a numeric value by clicking on the displayed number, and can increase or decrease the values clicking on the up/down arrow boxes.
- Cut and Paste - Right clicking on a displayed number opens a Cut, Copy, Paste dropdown menu for convenient numeric entry.

As mentioned before, these controls are for monitoring only, and do not change the audio recorded to a NLE file. Any actual recording level adjustments to Capture or Audio Punch In / Voice Over to Timeline operations will either need to be made upstream of the AJA input, or else via adjustments within the main NLE application (e.g. via a pass through mix tool).

Audio Mixer Capture Monitor Mode Screen

Figure 53. Audio Mixer Screen, Capture Monitor Mode

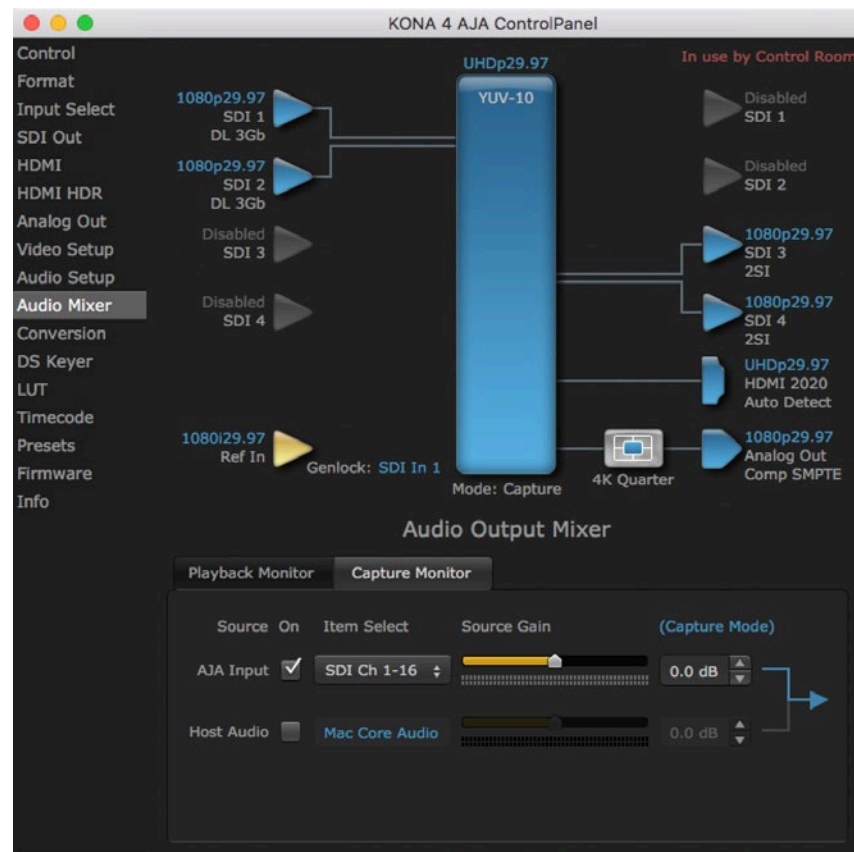

The Capture Monitor Mode screen is used to select and mix audio to be monitored during capture operations.

IMPORTANT: Even though you can hear changes in the signals and levels adjusted with the Audio Mixer screen, these changes are NOT recorded to disk during NLE Capture or Audio Punch In / Voice Over to Timeline. In addition, muting or activating sources on this screen will not affect audio signals being recorded. The Audio Mixer screen is dedicated for monitoring only, not program mixing.

The controls on this screen are similar to those on the Playback Monitor Mode screen, except the Main App is not available for selection (you cannot capture from the application that is capturing). See ["Audio Mixer Playback Monitor Mode Screen" on page 68](#) for more information.

NOTE: If you want different behavior when the Capture tab is triggered; i.e. for host system audio to be muted, then simply check the host system audio in the Capture tab only. This way when you exit NLE Capture and return to regular editing, the Playback tab settings will be applied and your host system audio monitoring will resume.

Downstream Keyer Screen in 4K Mode

Figure 54. AJA Control Panel, DS Keyer Screen with Unsupported Message

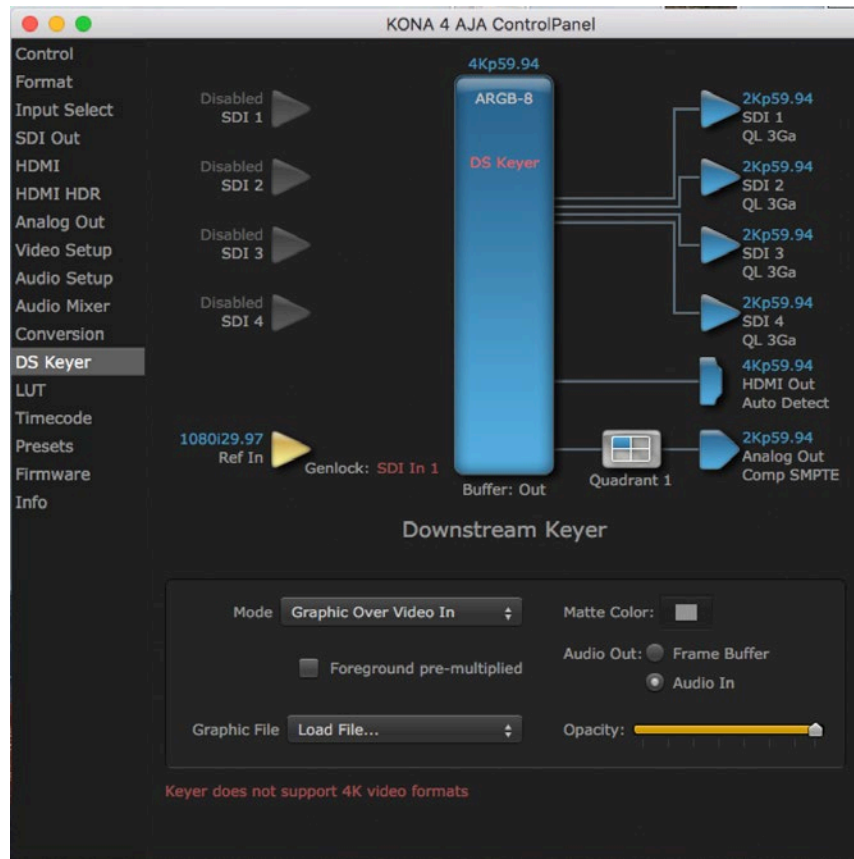

The KONA Downstream Keyer does not support UltraHD/4K formats, but is available for use with other video formats. If this screen is selected with a UltraHD/4K format configured, a “Keyer does not support 4K video formats” message will be displayed.

Who is Controlling KONA?

There are times when you might have several applications open at one time, and each of these might want to output their video through the KONA video output. KONA is very flexible and most applications perform the necessary housekeeping so they work correctly when they’re active and when they’re not. This means that the application that is “active” (in front) will be granted control of the KONA video output. Generally, when you switch to a different application, the previous application lets go of the video output and the new application gets control.

Figure 55. AJA Control Panel Control Message

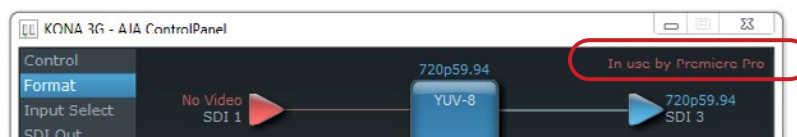

The AJA Control Panel in-use message will tell you the “active” application that has control of KONA (see in-use message above) and what the format selections are. If you click on another supported application that is running (such as Adobe Premiere Pro or AJA TV), the AJA Control Panel in-use message

will report the change by displaying the new “In use” application. If no in-use message is displayed, the AJA Control Panel is in control of KONA. If no QuickTime applications are running, the board’s state is determined by the AJA Control Panel application’s settings.

QuickTime Application Format Selection

If a running QuickTime application uses KONA for capture or output, it controls the Primary format via its own menus and settings. For example, when the Third-party editing application is active (it’s the front-most application) and has KONA as its “A/V Device”, the KONA’s Primary format is determined by the application’s “Video Playback” settings. These format selections are reported in the AJA Control Panel block diagram.

QuickTime applications can start and stop and change modes—even while they are running. And the behavior of different QuickTime applications can vary: some applications take control of the interface as soon as they are launched and don’t give it up until they quit, while other applications take control of the interface only when they are the “front-most” running application and then relinquish control when they’re not. Even these QuickTime applications may not relinquish control until capture or output operations are completed.

Control Recommendations

We recommend you have the Control Panel running and visible at all times. When the Control Panel is running in the background (not front-most) you can see what the interface is doing and who has control of it.

Using Multiple AJA Products

Starting with the v7.5 drivers, more than one AJA product can be used with your host computer. Using the AJA Control Panel application, you can choose which installed product an application uses for input/output. In the upper left corner of the AJA Control Panel application, you will see a board name, such as KONA 3G-0 and the pane heading will read “AJA Control Panel” if you have more than one product and the associated drivers installed (if only one product is installed, you’ll see no product or pulldown and the product name will appear in the header). To “target” a specific installed product for use, click on the text in the upper left hand side of the UI and select from the list of available products that appear in the pulldown.

Figure 56. Control Panel Screen Showing Multiple AJA Devices

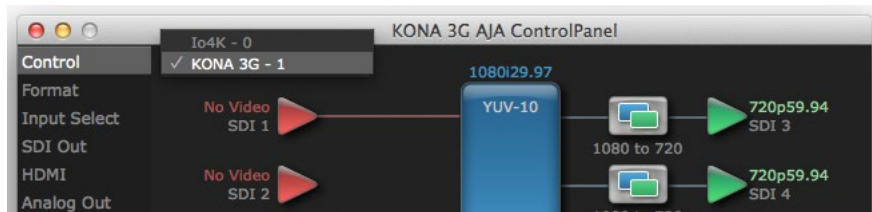

When you launch an application, or AJA TV, the application will use the product that is currently selected in the AJA Control Panel for its input/output. When an application is running, you can change the “targeted” product selection using the Control Panel pulldown menu. The running application will retain its connection to the product. If you change the “targeted” product and launch a different application, that application will use the new product for its input/output, while the first application you launched will continue to use the other AJA product.

Example: if you select a KONA card as the targeted product in the AJA Control Panel application and launch an Adobe video editing application, that application is now using the KONA card for its input/output. Go back to the AJA Control Panel application and select an Io Express as the “targeted” product. Launch the AJA TV application. AJA TV will now use the Io Express for its output. If you switch back to the Adobe application, you will see that it is still using the KONA 3G for its input/output. Note that some applications, like AJA TV, have a provision for playing in the background, so playback on one product could even continue when switching the targeted device for use with another application. In such cases, you can even feed the output from one AJA product to another AJA product on the same system.

Figure 57. AJA TV Preferences, Continue Playback when AJA TV is in background

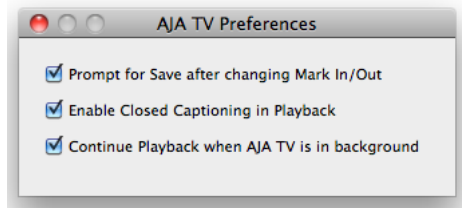

AJA TV optionally supports playback in the background; checkbox “Continue Playback when AJA TV is in background.”

Notes on Using Multiple AJA Products:

Performance of multi-product use depends on a variety of factors: CPU usage, RAM, disk IOPS/ bandwidth for streams of video, etc. and therefore performance may vary. Also be aware that multiple input/output streams are only supported by software that is explicitly designed for a multi-product environment.

Using 8-bit Versus 10-bit Video

While both 8- and 10-bit uncompressed video are capable of providing excellent quality broadcast video, 10-bit represents a significantly higher quality and is preferable in many situations.

Because 10-bit video has four times the numerical precision when compared to 8-bit, it has a signal-to-noise ratio 12 db higher than 8-bit video.

Visually, in 8-bit video compared to 10-bit video, you will notice a substantial difference. In 8-bit video there will be “contour lines” or “striations” visible, particularly noticeable in scenes having soft gradients like a ramp or sunset. For example, if a sky region is mostly the same color but varies by only a few digital numbers from one side of the picture to another, you may see contour lines where the signal passes from one digital value to the next higher value.

Since each numerical value in a 10-bit system is only one fourth as large as an 8-bit system’s, these contours become invisible and the sky varies smoothly.

10-bit video is often used when the source and output video (or “master”) is also 10-bit. Even if the input and/or output video is 8-bit, a 10-bit “project” will still maintain a higher quality when there is a significant amount of effects rendering involved.

Industry standard professional mastering formats—Sony Digital Betacam for Standard Definition and Panasonic D5 for High Definition—are both true 10-bit formats.

Appendix A – Specifications

KONA 5 Tech Specs

Video Formats

- (4K) 4096 x 2160P 23.98, 24, 25, 29.97, 30, 47.95, 48, 50, 59.94, 60
- (UltraHD) 3840 x 2160P 23.98, 24, 25, 29.97, 30, 47.95, 48, 50, 59.94, 60
- (2K) 2048 x 1080p 23.98, 24, 25, 29.97, 30, 47.95, 48, 50, 59.94, 60
- (2K) 2048 x 1080PsF 23.98, 24, 25, 29.97, 30
- (HD) 1080p 23.98, 24, 25, 29.97, 30, 47.95, 48, 50, 59.94, 60
- (HD) 1080PsF 23.98, 24, 25, 29.97, 30
- (HD) 1080i 50, 59.94, 60
- (HD) 720p 50, 59.94, 60
- (SD) 625i 50
- (SD) 525i 59.94

Note: High Frame Rate capabilities are dependent on host system attributes. Not all systems and configurations will support all frame rates.

Video Inputs Digital

- 12G-SDI*, SMPTE-2082, 12-bit**, 10-bit and 8-bit
- 6G-SDI*, SMPTE-2081, 10-bit and 8-bit
- 3G-SDI, SMPTE-259/292/296/424/425, 12-bit*, 10-bit and 8-bit
- 4K/UltraHD 4:4:4 (4x BNC)
- 1.5G-SDI, SMPTE 372M, Dual Link HD 4:4:4 (2x BNC), 12-bit**, 10-bit and 8-bit
- 1.5G-SDI, SMPTE 292M, Single Link 4:2:2 (1x BNC), 10-bit and 8-bit

*SDI connections are bidirectional. For 2K/HD, capture and monitoring can be simultaneous. For 4K/UltraHD with 12G-SDI, capture and monitoring can also be simultaneous. For 4K/UltraHD with 3G-SDI, all four connections must be used for either Input or Output. Additionally, 12G-SDI, 6G-SDI configured inputs support UltraHD / 4K only.

**Bit depth support is application dependent. Check with your software manufacturer for compatibility.

Video Outputs Digital

- 12G-SDI*, SMPTE-2082, 12-bit**, 10-bit and 8-bit
- 6G-SDI*, SMPTE-2081, 10-bit and 8-bit
- 3G-SDI, SMPTE-259/292/296/424, 12-bit*, 10-bit and 8-bit
- 4K/UltraHD 4:4:4 (4x BNC)
- 1.5G-SDI, SMPTE 372M, Dual Link HD 4:4:4 (2x BNC), 12-bit**, 10-bit and 8-bit
- 1.5G-SDI, SMPTE 292M, Single Link 4:2:2 (1x BNC), 10-bit and 8-bit
- HDMI v2.0
- 30/36 bits/pixel, RGB or YUV, 6 Gbps per color component
- 4K, UltraHD, 2K, HD and SD with HFR support up to 60p (4:2:2), 10-bit and 8-bit
- HDR10 Support - HDR Infoframe metadata, compatible with HDMI 2.0a/CTA-861.3
- HLG Support - compatible with HDMI 2.0b/CTA-861-G***

*SDI connections are bidirectional. For 2K/HD, capture and monitoring can be simultaneous. For 4K/UltraHD with 12G-SDI, capture and monitoring can also be simultaneous. For 4K/UltraHD with 3G-SDI, all four connections must be used for either Input or Output. Additionally, 12G-SDI, 6G-SDI configured outputs support UltraHD / 4K only.

**Bit depth support is application dependent. Check with your software manufacturer for compatibility.

***HLG support is application dependent. Check with your software manufacturer for compatibility.

Audio Inputs Digital

- 16-Channel, 24 and 16-bit SDI embedded audio, 48 kHz sample rate, synchronous
- 8-Channel, 24 and 16-bit HDMI embedded audio, 48 kHz sample rate, synchronous
- 8-Channel, 16 and 24-bit AES/EBU audio, 48 kHz sample rate, synchronous or nonsynchronous, internal sample rate conversion (via 4x BNC on breakout cable)

Audio Outputs Digital

- 16-Channel, 24-bit SDI embedded audio, 48 kHz sample rate, synchronous
- 8-Channel, 24-bit HDMI embedded audio, 48 kHz sample rate, synchronous
- 8-Channel, 16 and 24-bit AES/EBU audio, 48 kHz sample rate, synchronous or nonsynchronous, internal sample rate conversion (via 4x BNC on breakout cable)

Downstream Keyer

- Supports graphics with alpha channel over video, matte or framebuffer, or framebuffer content over incoming video or matte

Reference

- Analog Color Black (1V) or Composite Sync (2 or 4V) or HD Tri-Level Sync (1V) (via 1x HD-BNC at PCIe bracket)
- Reference input is terminated into 75 ohms when Genlock is set to Ref In

Timecode

- LTC timecode input and output (via 2x BNC on breakout cable)
- LTC timecode input (via 2-pin header on PCIe card)
- LTC timecode input (via HD-BNC at PCIe bracket)

Electrical Interface

- 8-lane PCIe 3.0

Machine Control

- 9-pin D-connector pinout is as follows:
 - 1 GND
 - 2 RX-
 - 3 TX+
 - 4 GND
 - 5 No Connection
 - 6 GND
 - 7 RX+
 - 8 TX-
 - 9 GND
- Shell GND

Noise

- <50dBA (A-weighted at 1m in free air)

Size (w x d x h)

- 0.75" x 6.9" x 5.0" (19.05 x 175.26 x 127.00 mm)

Weight

- PCIe Card: 0.6 lbs (0.3 kg)
- Cables (all combined): 1.3 lbs (0.6 kg)

Power

- 28W typical, 35W maximum

Environment

- Safe Operating Temperature: 0 to 40 C (32 to 104 F)
- Safe Storage Temperature (Power OFF): -40 to 60 C (-40 to 140 F)
- Operating Relative Humidity: 10-90% noncondensing
- Operating Altitude: <3,000 meters (<10,000 feet)

KONA 4 Tech Specs

Video Formats

- (4K) 4096 x 2160p 23.98, 24, 25, 50, 59.94, 60
- (UltraHD) 3840 x 2160p 23.98, 24, 25, 29.97, 50, 59.94, 60
- (2K) 2048 x 1556p 15, 14.98
- (2K) 2048 x 1556PsF 15, 23.98, 24
- (2K) 2048 x 1080p 23.98, 24, 25, 29.97, 30, 50, 59.94, 60
- (2K) 2048 x 1080PsF 23.98, 24, 25
- (HD) 1080i 50, 59.94, 60
- (HD) 1080PsF 23.98, 24, 25, 29.97, 30
- (HD) 1080p 23.98, 24, 25, 29.97, 30, 50, 59.94, 60
- (HD) 720p 23.98*, 24*, 25*, 29.97*, 30*, 50, 59.94, 60
- (SD) 625i 50
- (SD) 525i 23.98*, 59.94

*These formats are dependent on specific software functionality and are not normal over the wire formats.

Video Input Digital

- 3G-SDI, SMPTE-259/292/296/424/425, 8-bit, 10-bit and 12-bit*
- 4K/UltraHD 4:2:2 and 4:4:4 up to 50/60 fps
- 2K HSDL (High Speed Data Link) 4:4:4, (2x BNC)
- Dual Link HD 4:4:4 (2x BNC)
- Single Link 4:2:2 or 4:4:4 (1x BNC)
- 1D LUT support

*Bit depth support is application dependent. Check with your software manufacturer for compatibility.

Video Output Digital

- 3G-SDI, SMPTE-259/292/296/424, 8-bit, 10-bit and 12-bit*
- 4K/UltraHD 4:2:2 and 4:4:4 up to 50/60 fps
- 2K HSDL (High Speed Data Link) 4:4:4, (2x BNC)
- Dual Link HD 4:4:4, (2x BNC)
- Single Link 4:2:2 or 4:4:4 (1x BNC)
- HDMI v1.4b
 - 30/36 bits/pixel, RGB or YUV, 2.25 Gbps
 - 2K, HD, and SD, UltraHD with HFR support up to 60p 4:2:0
 - HDR 10 Support - HDR Infoframe metadata, in accordance with HDMI 2.0a/CTA-861.3
 - HLG Support - in accordance with HDMI 2.0b/CTA-861-G**

*Bit depth support is application dependent. Check with your software manufacturer for compatibility.

**HLG support is application dependent. Check with your software manufacturer for compatibility.

Video Output Analog

- Composite/S-Video (Y/C) (1x BNC/2x BNC+adapter)
- NTSC, NTSCJ, PAL
- Component (3x BNC)
- HD: YPbPr, RGB
- SD: YPbPr, RGB (component mode)
- SMPTE/EBU N10, Betacam 525 line, Betacam 525J, RGB
- 12-bit D/A, 8x oversampling
- +/- .2 dB to 5.0 MHz Y frequency response
- +/- .2 dB to 1 MHz C frequency response
- 5% 2T pulse response
- <1% Diff Phase
- <1% Diff Gain
- <1% ns Y/C delay inequity

Audio Input Digital

- 16-Channel, 16- and 24-bit SDI embedded audio, 48 kHz sample rate, synchronous
- 16-Channel, 16- and 24-bit AES/EBU audio, 48 kHz sample rate, synchronous (via 8 x BNC on optional K3G-Box)
- 8-Channel, 16- and 24-bit AES/EBU audio, 48 kHz sample rate, synchronous or nonsynchronous, internal sample rate conversion (via 4x BNC on breakout cable)

Audio Output Digital

- 16-Channel, 16- and 24-bit SDI embedded audio, 48 kHz sample rate, synchronous
- 16-Channel, 16- and 24-bit AES/EBU audio, 48 kHz sample rate, synchronous (via 8 x BNC on optional K3G-Box)
- 8-Channel, 16- and 24-bit HDMI embedded audio, 48 kHz sample rate, synchronous
- 8-Channel, 16- and 24-bit AES/EBU audio, 48 kHz sample rate, synchronous or nonsynchronous, internal sample rate conversion (via 4x BNC on breakout cable)

Downstream Keyer

- Supports graphics with alpha channel over video, matte or framebuffer, or framebuffer content over incoming video or matte

SD to SD Aspect Ratio Conversion

- Letterbox: This transforms SD anamorphic material to a letterboxed image
- H Crop: Will produce a horizontally stretched effect on the image; transforms anamorphic SD to full frame
- SD Pillarbox: Will produce an image in the center of the screen with black borders on the left and right sides and an anamorphized image in the center
- V Crop: Will transform SD letterbox material to an anamorphic image

Timecode

- LTC timecode input and output (via 1x BNC each)

Reference Input

- Analog color black (1V) or composite sync (2 or 4V)
- Looping
- 75 ohms on optional K3G-Box, terminated on supplied breakout cable

Electrical Interface

- 8-lane PCIe 2.0

Machine Control

- RS-422, Sony 9-pin protocol (via breakout cable or optional K3G-Box)
- 9-pin D-connector pinout is as follows:
 - 1 GND
 - 2 RX-
 - 3 TX+
 - 4 GND
 - 5 No Connection
 - 6 GND
 - 7 RX+
 - 8 TX-
 - 9 GND
- Shell GND

Size (w x d x h)

- .75" x 6.9" x 5.0" (19.05mm x 175.26mm x 127mm)

Weight

- 0.7 lb (0.4 kg)

Power

- 22W typical, 24W maximum

Environment

- Safe Operating Temperature: 0 to 40 degrees C (32 to 104 degrees F)
- Safe Storage Temperature (Power OFF): -40 to 60 degrees C (-40 to 140 degrees F)
- Operating Relative Humidity: 10-90% noncondensing
- Operating Altitude: <3,000 meters (<10,000 feet)

KONA 3G Tech Specs

Video Formats

- (4K) 4096 x 2160p 23.98, 24, 25, 29.97, 30
- (UltraHD) 3840 x 2160p 23.98, 24, 25, 29.97, 30
- (2K) 2048 x 1080p 23.98, 24, 25, 29.97, 30, 50 and 60
- (2K) 2048 x 1080PsF 23.98, 24, 25
- (2K) 2048 x 1556p 15, 14.98
- (2K) 2048 x 1556PsF 15, 23.98, 24
- (HD) 1080i 50, 59.94, 60
- (HD) 1080PsF 23.98, 24, 25, 29.97, 30
- (HD) 1080p 23.98, 24, 25, 29.97, 30, 50, 59.94, 60
- (HD) 720p 23.98*, 24*, 25*, 29.97*, 30*, 50, 59.94, 60
- (SD) 625i 50
- (SD) 525i 23.98*, 59.94

* These formats are dependent on specific software functionality and are not normal over the wire formats.

Video Input Digital

- 4K/UltraHD 422 and 444 (4x BNC)
- 2K HSDL (High Speed Data Link) 4:4:4, (2x BNC)
- 3G/SD/HD SDI, SMPTE-259/292/296/424, 8 or 10-bits
- Dual Link HD 4:4:4 (2x BNC)
- Single Link 4:2:2 or 4:4:4 (1x BNC)
- 1D LUT Support

Video Output Digital

- 4K/UltraHD 422 and 444 (4x BNC)
- 2K HSDL (High Speed Data Link) 4:4:4, (2x BNC)
- 3G/SD/HD SDI, SMPTE-259/292/296/424
- Dual Link HD 4:4:4, (2x BNC)
- Single Link 4:2:2 or 4:4:4 (1x BNC)
- HDMI v1.4, 30/36 bits/pixel, RGB or YUV, 2.25Gbps, SD, HD, 1080p-50/60 (1x mini-HDMI)

Video Output Analog

- Composite/S-Video (Y/C) (1x BNC/2x BNC+Adapter)
- NTSC, NTSCJ, PAL
- Component (3x BNC)
- HD: YPbPr, RGB
- SD: YPbPr, RGB (component mode)
- SMPTE/EBU N10, Betacam 525 line, Betacam 525J, RGB
- 12-bit D/A, 8 x oversampling
- +/- .2 dB to 5.0 MHz Y frequency response
- +/- .2 dB to 1 MHz C frequency response
- .5% 2T pulse response
- <1% Diff Phase
- <1% Diff Gain
- <1 ns Y/C delay inequity

Audio Input Digital

- 16-Channel, 16- and 24-bit SMPTE-259 SDI embedded audio, 48 kHz sample rate, synchronous
- 16-Channel, 16- and 24-bit AES/EBU audio, 48 kHz sample rate, synchronous (via 8 x BNC on optional K3G-Box)
- 8-Channel, 16- and 24-bit AES/EBU audio, 48 kHz sample rate, synchronous or nonsynchronous, internal sample rate conversion (via 4 x BNC on breakout cable)

Audio Output Digital

- 16-Channel, 16- and 24-bit SMPTE-259 SDI embedded audio, 48 kHz sample rate, synchronous
- 16-Channel, 16- and 24-bit AES/EBU audio, 48 kHz sample rate, synchronous (via 8x BNC on optional K3G-Box)
- 8-Channel, 16- and 24-bit HDMI embedded audio, 48 kHz sample rate, synchronous
- 8-Channel, 16- and 24-bit AES/EBU audio, 48 kHz sample rate, synchronous or nonsynchronous, internal sample rate conversion (via 4x BNC on breakout cable)

Audio Output Analog

- 2-Channel unbalanced output (via 2x RCA jacks on optional K3G-Box)

Downstream Keyer

- Supports graphics with alpha channel over video, matte or framebuffer, or framebuffer content over incoming video or matte.

Up-Conversion

- Hardware 10-bit
- Anamorphic: fullscreen
- Pillarbox 4:3: results in a 4:3 image in center of screen with black sidebars
- Zoom 14:9: results in a 4:3 image zoomed slightly to fill a 14:9 image with black side bars
- Zoom Letterbox: results in image zoomed to fill full screen
- Zoom Wide: results in a combination of zoom and horizontal stretch to fill a 16:9 screen; this setting can introduce a small aspect ratio change

Down-Conversion

- Hardware 10-bit
- Anamorphic: fullscreen
- Letterbox: image is reduced with black top and bottom added to image area with the aspect ratio preserved
- Crop: image is cropped to fit new screen size

Cross-Conversion

- Hardware 10-bit
- 1080i to 720p
- 720p to 1080i
- 720p to 1080PsF

SD to SD aspect ratio conversion

- Letterbox: This transforms SD anamorphic material to a letterboxed image
- H Crop: Will produce a horizontally stretched effect on the image; transforms anamorphic SD to full frame
- SD Pillarbox: Will produce an image in the center of the screen with black borders on the left and right sides and an anamorphized image in the center
- V Crop: Will transform SD letterbox material to an anamorphic image

Timecode

- LTC timecode input and output (via 1x BNC each)

Reference Input

- Analog Color Black (1V) or Composite Sync (2 or 4V)
- Looping
- 75 ohm on optional K3G-Box, terminated on supplied breakout cable

Electrical Interface

- 4-lane PCIe 2.0

Machine Control

- RS-422, Sony 9-pin protocol (via breakout cable or optional K3G-Box)
- 9-pin D-connector pinout is as follows:
 - 1 GND
 - 2 RX-
 - 3 TX+
 - 4 GND
 - 5 No Connection
 - 6 GND
 - 7 RX+
 - 8 TX-
 - 9 GND
- Shell GND

Size (w x d x h)

- .75" x 8.25" x 5.0" (19.05mm x 209.55mm x 127mm)

Weight

- 0.7 lb (0.4 kg)

Power

- 19W typical, 21W maximum

Environment

- Safe Operating Temperature: 0 to 40 degrees C (32 to 104 degrees F)
- Safe Storage Temperature (Power OFF): -40 to 60 degrees C (-40 to 140 degrees F)
- Operating Relative Humidity: 10-90% noncondensing
- Operating Altitude: <3,000 meters (<10,000 feet)

KONA 1 Tech Specs

Video Formats

- (2K) 2048 x 1080p 23.98, 24, 25, 29.97, 30, 50, 59.94, 60
- (2K) 2048 x 1080PsF 23.98, 24, 25
- (HD) 1080i 50, 59.94, 60
- (HD) 1080PsF 23.98, 24, 25, 29.97, 30
- (HD) 1080p 23.98, 24, 25, 29.97, 30, 50, 59.94, 60
- (HD) 720p 50, 59.94, 60
- (SD) 625i 50
- (SD) 525i 59.94

Video Input Digital

- 3G-SDI, SMPTE-259/292/296/424

Video Output Digital

- 3G-SDI, SMPTE-259/292/296/424

Audio Input Digital

- 16-Channel 24-bit SDI embedded, 48 kHz synchronous

Audio Output Digital

- 16-Channel 24-bit SDI embedded, 48 kHz synchronous

Reference / LTC Input

- Analog Color Black or HD Tri-level sync
- LTC

Electrical Interface

- 2-lane PCIe 2.0

Machine Control

- RS-422, Sony 9-pin protocol
- 9-pin D-connector pinout is as follows:
 - 1 GND
 - 2 RX-
 - 3 TX+
 - 4 GND
 - 5 No Connection
 - 6 GND
 - 7 RX+
 - 8 TX-
 - 9 GNDShell GND

Size (w x d x h)

- 0.55" x 6.61" x 2.16" (13.97 x 167.89 x 54.86 mm)

Weight

- 0.3 lb (0.3 kg)

Environment

- Safe Operating Temperature: 0 to 40 C (32 to 104 F)
- Safe Storage Temperature (Power OFF): -40 to 60 C (-40 to 140 F)
- Operating Relative Humidity: 10-90% noncondensing
- Operating Altitude: <3,000 meters (<10,000 feet)

Appendix B – Safety & Compliance

Federal Communications Commission (FCC) Compliance Notices

Class B Interference Statement

This equipment has been tested and found to comply with the limits for a Class B digital device, pursuant to Part 15, Subpart B of the FCC Rules. These limits are designed to provide reasonable protection against harmful interference in a residential installation. This equipment generates, uses, and can radiate radio frequency energy and, if not installed and used in accordance with the instructions, may cause harmful interference to radio communications. However, there is no guarantee that interference will not occur in a particular installation. If this equipment does cause harmful interference to radio or television reception, which can be determined by turning the equipment off and on, the user is encouraged to try to correct the interference by one or more of the following measures:

- Reorient or relocate the receiving antenna.
- Increase the separation between the equipment and receiver.
- Connect the equipment into an outlet on a circuit different from that to which the receiver is connected.
- Consult the dealer or an experienced radio/TV technician for help.

FCC Caution

This device complies with Part 15 of the FCC Rules. Operation is subject to the following two conditions: (1) This device may not cause harmful interference, and (2) this device must accept any interference received, including interference that may cause undesired operation.

Canadian ICES Statement

Canadian Department of Communications Radio Interference Regulations

This digital apparatus does not exceed the Class B limits for radio-noise emissions from a digital apparatus as set out in the Radio Interference Regulations of the Canadian Department of Communications. This Class B digital apparatus complies with Canadian ICES-003.

Règlement sur le brouillage radioélectrique du ministère des Communications

Cet appareil numérique respecte les limites de bruits radioélectriques visant les appareils numériques de classe B prescrites dans le Règlement sur le brouillage radioélectrique du ministère des Communications du Canada. Cet appareil numérique de la Classe B est conforme à la norme NMB-003 du Canada.

European Union and European Free Trade Association (EFTA) Regulatory Compliance

This equipment may be operated in the countries that comprise the member countries of the European Union and the European Free Trade Association. These countries, listed in the following paragraph, are referred to as The European Community throughout this document:

AUSTRIA, BELGIUM, BULGARIA, CYPRUS, CZECH REPUBLIC, DENMARK, ESTONIA, FINLAND, FRANCE, GERMANY, GREECE, HUNGARY, IRELAND, ITALY, LATVIA, LITHUANIA, LUXEMBOURG, MALTA, NETHERLANDS, POLAND, PORTUGAL, ROMANIA, SLOVAKIA, SLOVENIA, SPAIN, SWEDEN, UNITED KINGDOM, ICELAND, LICHTENSTEIN, NORWAY, SWITZERLAND

Declaration of Conformity

Marking by this symbol indicates compliance with the Essential Requirements of the EMC Directive of the European Union 2014/30/EU.



This equipment meets the following conformance standards:

Safety

EN 60065: 2014 (T-Mark License),

IEC 60065: 2014, (CB Scheme Report/Certificate)

Additional licenses issued for specific countries available on request.

Emissions

EN 55032: 2012 + AC: 2013, CISPR 32: 2015

EN 61000-3-2: 2014, EN 61000-3-3: 2013

Immunity

EN 55103-2: 2009, EN 61000-4-2:2009, EN 61000-4-3:2006 +A1:2008 +A2:2010,

EN 61000-4-4:2004+ A1:2010, EN 61000-4-5:2006, EN 61000-4-6:2009,

EN 61000-4-11:2004

Environments: E2, E3 and E4

The product is also licensed for additional country specific standards as required for the International Marketplace.



Warning! This is a Class B product. In a domestic environment, this product may cause radio interference, in which case, the user may be required to take appropriate measures.

Achtung! Dieses ist ein Gerät der Funkstörgrenzwertklasse B. In Wohnbereichen können bei Betrieb dieses Gerätes Rundfunkstörungen auftreten, in welchen Fällen der Benutzer für entsprechende Gegenmaßnahmen verantwortlich ist.

Attention! Ceci est un produit de Classe B. Dans un environnement domestique, ce produit risque de créer des interférences radioélectriques, il appartiendra alors à l'utilisateur de prendre les mesures spécifiques appropriées.

Recycling Notice



This symbol on the product or its packaging indicates that this product must not be disposed of with your other household waste. Instead, it is your responsibility to dispose of your waste equipment by handing it over to a designated collection point for the recycling of waste electrical and electronic equipment. The separate collection and recycling of your waste equipment at the time of disposal will help conserve natural resources and ensure that it is recycled in a manner that protects human health and the environment. For more information about where you can drop off your waste for recycling, please contact your local authority, or where you purchased your product.

Korea KCC Compliance Statement

<p>B급 기기 (가정용 방송통신기자재)</p> <p>Class B (Broadcasting Communication Equipment for Home Use)</p>	<p>이 기기는 가정용(B급) 전자파적합기기로서 주로 가정에서 사용하는 것을 목적으로 하며, 모든 지역에서 사용할 수 있습니다.</p> <p>As an electromagnetic wave equipment for home use (Class B), this equipment is intended to use mainly for home use and may be used in all areas.</p>
---	---

Taiwan Compliance Statement

警告使用者：
這是甲類的資訊產品，在居住的環境中使用時，可能會造成射頻干擾，在這種情況下，使用者會被要求採取某些適當的對策。

This is a Class B product based on the standard of the Bureau of Standards, Metrology and Inspection (BSMI) CNS 13438, Class B. In a domestic environment this product may cause radio interference in which case the user may be required to take adequate measures.

Japan Compliance Statement

この装置は、クラスB情報技術装置です。この装置は、家庭環境で使用することを目的としていますが、この装置がラジオやテレビジョン受信機に近接して使用されると、受信障害を引き起こすことがあります。
取扱説明書に従って正しい取り扱いをして下さい。 VCCI-B

This is a Class B product based on the standard of the VCCI Council (VCCI 32: 2016). If this is used near a radio or television receiver in a domestic environment, it may cause radio interference. Install and use the equipment according to the instruction manual.

Translated Warning and Caution Messages

The following caution statements, warning conventions, and warning messages apply to this product and manual.



Warning Symbol



Caution Symbol

Before Operation Please Read These Instructions



Warning! Read and follow all warning notices and instructions marked on the product or included in the documentation.

Avertissement! Lisez et conformez-vous à tous les avis et instructions d'avertissement indiqués sur le produit ou dans la documentation.

Warnung! Lesen und befolgen Sie die Warnhinweise und Anweisungen, die auf dem Produkt angebracht oder in der Dokumentation enthalten sind.

¡Advertencia! Lea y siga todas las instrucciones y advertencias marcadas en el producto o incluidas en la documentación.

Aviso! Leia e siga todos os avisos e instruções assinalados no produto ou incluídos na documentação.

Avviso! Leggere e seguire tutti gli avvisi e le istruzioni presenti sul prodotto o inclusi nella documentazione.



Warning! Do not use this device near water and clean only with a dry cloth.

Avertissement! N'utilisez pas cet appareil près de l'eau et nettoyez-le seulement avec un tissu sec.

Warnung! Das Gerät nicht in der Nähe von Wasser verwenden und nur mit einem trockenen Tuch säubern.

¡Advertencia! No utilice este dispositivo cerca del agua y límpielo solamente con un paño seco.

Aviso! Não utilize este dispositivo perto da água e limpe-o somente com um pano seco.

Avviso! Non utilizzare questo dispositivo vicino all'acqua e pulirlo soltanto con un panno asciutto.



Warning! Do not block any ventilation openings. Install in accordance with the manufacturer's instructions.

Avertissement! Ne bloquez aucune ouverture de ventilation. Suivez les instructions du fabricant lors de l'installation.

Warnung! Die Lüftungsöffnungen dürfen nicht blockiert werden. Nur gemäß den Anweisungen des Herstellers installieren.

¡Advertencia! No bloquee ninguna de las aberturas de la ventilación. Instale de acuerdo con las instrucciones del fabricante.

Aviso! Não obstrua nenhuma das aberturas de ventilação. Instale de acordo com as instruções do fabricante.

Avviso! Non ostruire le aperture di ventilazione. Installare in conformità con le istruzioni del fornitore.



Warning! Do not install near any heat sources such as radiators, heat registers, stoves, or other apparatus (including amplifiers) that produce heat.

Avertissement! N'installez pas l'appareil près d'une source de chaleur telle que des radiateurs, des bouches d'air de chauffage, des fourneaux ou d'autres appareils (amplificateurs compris) qui produisent de la chaleur.

Warnung! Nicht in der Nähe von Wärmequellen wie Heizkörpern, Heizregistern, Öfen oder anderen Wärme erzeugenden Geräten (einschließlich Verstärkern) aufstellen.

¡Advertencia! No instale cerca de fuentes de calor tales como radiadores, registros de calor, estufas u otros aparatos (incluidos amplificadores) que generan calor.

Aviso! Não instale perto de nenhuma fonte de calor tal como radiadores, saídas de calor, fogões ou outros aparelhos (incluindo amplificadores) que produzam calor.

Avviso! Non installare vicino a fonti di calore come termosifoni, diffusori di aria calda, stufe o altri apparecchi (amplificatori compresi) che emettono calore



Warning! Unplug this device during lightning storms or when unused for long periods of time.

Avertissement! Débranchez cet appareil pendant les orages avec éclairs ou s'il est inutilisé pendant de longues périodes.

Warnung! Das Gerät ist bei Gewitterstürmen oder wenn es über lange Zeiträume ungenutzt bleibt vom Netz zu trennen.

¡Advertencia! Desenchufe este dispositivo durante tormentas eléctricas o cuando no se lo utilice por largos periodos del tiempo.

Aviso! Desconecte este dispositivo da tomada durante trovoadas ou quando não é utilizado durante longos períodos de tempo.

Avviso! Utilizzare soltanto i collegamenti e gli accessori specificati e/o venduti dal produttore, quali il treppiedi e l'esoscheletro.



Warning! Only use attachments and accessories specified and/or sold by the manufacturer.

Avertissement! Utilisez seulement les attaches et accessoires spécifiés et/ou vendus par le fabricant.

Warnung! Verwenden Sie nur Zusatzgeräte und Zubehör angegeben und / oder verkauft wurde durch den Hersteller.

¡Advertencia! Utilice solamente los accesorios y conexiones especificados y/o vendidos por el fabricante.

Aviso! Utilize apenas equipamentos/acessórios especificados e/ou vendidos pelo fabricante.

Avviso! Utilizzare soltanto i collegamenti e gli accessori specificati e/o venduti dal produttore.



Warning! Refer all servicing to qualified service personnel. Servicing is required when the device has been damaged in any way, such as power-supply cord or plug is damaged, liquid has been spilled or objects have fallen into the device, the device has been exposed to rain or moisture, does not operate normally, or has been dropped.

Avertissement! Référez-vous au personnel de service qualifié pour tout entretien. L'entretien est exigé quand l'appareil a été endommagé de quelque manière que ce soit, par exemple lorsque le cordon d'alimentation ou la prise sont endommagés, que du liquide a été versé ou des objets sont tombés dans l'appareil, que l'appareil a été exposé à la pluie ou à l'humidité, ne fonctionne pas normalement ou est tombé.

Warnung! Das Gerät sollte nur von qualifizierten Fachkräften gewartet werden. Eine Wartung ist fällig, wenn das Gerät in irgendeiner Weise beschädigt wurde, wie bei beschädigtem Netzkabel oder Netzstecker, falls Flüssigkeiten oder Objekte in das Gerät gelangen, das Gerät Regen oder Feuchtigkeit ausgesetzt wurde, nicht ordnungsgemäß funktioniert oder fallen gelassen wurde.

¡Advertencia! Consulte al personal calificado por cuestiones de reparación. El servicio de reparación se requiere cuando el dispositivo ha recibido cualquier tipo de daño, por ejemplo cable o espigas dañadas, se ha derramado líquido o se han caído objetos dentro del dispositivo, el dispositivo ha sido expuesto a la lluvia o humedad, o no funciona de modo normal, o se ha caído.

Aviso! Remeta todos os serviços de manutenção para o pessoal de assistência qualificado. A prestação de serviços de manutenção é exigida quando o dispositivo foi danificado mediante qualquer forma, como um cabo de alimentação ou ficha que se encontra danificado/a, quando foi derramado líquido ou caíram objectos sobre o dispositivo, quando o dispositivo foi exposto à chuva ou à humidade, quando não funciona normalmente ou quando foi deixado cair.

Avviso! Fare riferimento al personale qualificato per tutti gli interventi di assistenza. L'assistenza è necessaria quando il dispositivo è stato danneggiato in qualche modo, ad esempio se il cavo di alimentazione o la spina sono danneggiati, è stato rovesciato del liquido è stato rovesciato o qualche oggetto è caduto nel dispositivo, il dispositivo è stato esposto a pioggia o umidità, non funziona correttamente o è caduto



Warning! Do not defeat the safety purpose of the polarized or grounding-type plug. A polarized plug has two blades with one wider than the other. A grounding type plug has two blades and a third grounding prong. The wide blade or the third prong are provided for your safety. If the provided plug does not fit into your outlet, consult an electrician for replacement of the obsolete outlet.

Avertissement! La sécurité de la prise polarisée ou de la prise de type mise à la terre ne doit en aucun cas être empêchée de fonctionner. Une prise polarisée a deux broches, l'une étant plus large que l'autre. Une prise de type mise à la terre a deux broches et une troisième broche pour la mise à la terre. La broche large ou la troisième broche sont fournies pour votre sécurité. Si la prise fournie ne s'insère pas dans votre prise femelle, consultez un électricien pour le remplacement de la prise femelle obsolète.

Warnung! Der Sicherheitszweck des gepolten bzw. Schukosteckers ist zu berücksichtigen. Ein gepolter Stecker verfügt über zwei Pole, von denen einer breiter als der andere ist. Ein Schukostecker verfügt neben den zwei Polen noch über einen dritten Pol zur Erdung. Der breite Pol bzw. der Erdungspol dienen der Sicherheit. Wenn der zur Verfügung gestellte Stecker nicht in Ihren Anschluss passt, konsultieren Sie einen Elektriker, um den veralteten Anschluss zu ersetzen.

¡Advertencia! No eche por tierra la finalidad del tipo de enchufe polarizado con conexión a tierra. Un enchufe polarizado tiene dos espigas, una más ancha que la otra. Un enchufe con conexión a tierra tiene dos espigas iguales y una tercera espiga que sirve para la conexión a tierra. La espiga ancha, o la tercera espiga, sirven para su seguridad. Si el enchufe suministrado no encaja en el tomacorriente, consulte con un electricista para reemplazar el tomacorriente obsoleto.

Aviso! Não anule a finalidade da segurança da ficha polarizada ou do tipo ligação terra. Uma ficha polarizada tem duas lâminas sendo uma mais larga do que a outra. Uma ficha do tipo de ligação à terra tem duas lâminas e um terceiro terminal de ligação à terra. A lâmina larga ou o terceiro terminal são fornecidos para sua segurança. Se a ficha fornecida não couber na sua tomada, consulte um electricista para a substituição da tomada obsoleta.

Avviso! Non compromettere la sicurezza della spina polarizzata o con messa a terra. Una spina polarizzata ha due spinotti, di cui uno più largo. Una spina con messa a terra ha due spinotti e un terzo polo per la messa a terra. Lo spinotto largo o il terzo polo sono forniti per motivi di sicurezza. Se la spina fornita non si inserisce nella presa di corrente, contattare un elettricista per la sostituzione della presa obsoleta.



Warning! Since the Mains plug is used as the disconnection for the device, it must remain readily accessible and operable.

Avertissement! Puisque la prise principale est utilisée pour débrancher l'appareil, elle doit rester aisément accessible et fonctionnelle.

Warnung! Da der Netzstecker als Trennvorrichtung dient, muss er stets zugänglich und funktionsfähig sein.

¡Advertencia! Puesto que el enchufe de la red eléctrica se utiliza como dispositivo de desconexión, debe seguir siendo fácilmente accesible y operable.

Aviso! Dado que a ficha principal é utilizada como a desconexão para o dispositivo, esta deve manter-se prontamente acessível e funcional.

Avviso! Poiché il cavo di alimentazione viene usato come dispositivo di sconnessione, deve rimanere prontamente accessibile e operabile.



Warning! Protect the power cord from being walked on or pinched particularly at plugs, convenience receptacles, and the point where they exit from the device.

Avertissement! Protégez le cordon d'alimentation pour que l'on ne marche pas dessus ou qu'on le pince, en particulier au niveau des prises mâles, des réceptacles de convenance, et à l'endroit où il sort de l'appareil.

Warnung! Vermeiden Sie, dass auf das Netzkabel getreten oder das Kabel geknickt wird, insbesondere an den Steckern, den Steckdosen und am Kabelausgang am Gerät.

¡Advertencia! Proteja el cable de energía para que no se le pise ni apriete, en especial cerca del enchufe, los receptáculos de conveniencia y el punto del que salen del equipo.

Aviso! Proteja o cabo de alimentação de ser pisado ou de ser comprimido particularmente nas fichas, em tomadas de parede de conveniência e no ponto de onde sai do dispositivo.

Avviso! Proteggere il cavo di alimentazione in modo che nessuno ci cammini sopra e che non venga schiacciato soprattutto in corrispondenza delle spine e del punto in cui esce dal dispositivo.



Warning! Disconnect the external AC power supply line cord(s) from the mains power before moving the unit.

Avertissement! Retirez le ou les cordons d'alimentation en CA de la source d'alimentation principale lorsque vous déplacez l'appareil.

Warnung! Trennen Sie die Wechselstrom-Versorgungskabel vom Netzstrom, bevor Sie das Gerät verschieben.

¡Advertencia! Cuando mueva la unidad desenchufe de la red eléctrica el/los cable(s) de la fuente de alimentación CA tipo brick.

Advertência! Remova os cabos CA de alimentação brick da rede elétrica ao mover a unidade.

Avvertenza! Scollegare il cavo dell'alimentatore quando si sposta l'unità.

Warranty and Liability Information

AJA VIDEO SYSTEMS, INC.

Limited Warranty on Hardware

AJA Video Systems, Inc. (AJA Video) warrants that the hardware product, not including storage modules or software components, will be free from defects in materials and workmanship for a period of three (3) years from the date of purchase. AJA Video warrants that the storage modules provided as part of the hardware product will be free from defects in materials and workmanship for a period of one year from the date of purchase. AJA Video provides a separate software warranty as part of the license agreement applicable to software components.

If a hardware product or storage module (hereafter, a “product”) proves to be defective during the applicable warranty period, AJA Video, at its option, will either repair the defective product without charge for parts and labor, or will provide a replacement in exchange for the defective product.

To obtain service under this warranty, the Customer must notify AJA Video of the defect before expiration of the warranty period and make suitable arrangements for the performance of service by contacting AJA Video support through the channels set forth on the support contacts web page at <http://www.aja.com/support>. Except as stated, the Customer shall bear all shipping, packing, insurance and other costs, excluding parts and labor, to effectuate repair. Customer shall pack and ship the defective product to a service center designated by AJA Video, with shipping charges prepaid. AJA Video shall pay to return the product to Customer but only if to a location within the country in which the AJA Video service center is located.

This warranty shall not apply to any defect, failure or damage caused by negligent, inadequate or improper use, handling or maintenance. Without limiting the foregoing, AJA Video shall not be obligated to furnish service under this warranty or repair any damage or malfunction a) resulting from attempts by personnel other than AJA Video representatives to install, repair or service the product, b) resulting from improper use or connection to incompatible equipment, c) caused by the use of non-AJA Video parts or supplies, d) if the product has been modified or integrated with other products when the effect of such a modification or integration increases the time or difficulty of servicing the product, or e) resulting from being dropped or otherwise subjected to undue force, exposure to moisture or other corrosive or conductive substances, exposure to strong magnetic fields, use with improperly regulated power supplies, exposure to electric shock, use in temperatures outside the specified operating range, or otherwise failing to treat the product in accordance with the standard of care appropriate to sensitive and delicate electronic equipment.

EXCEPT AS STATED ABOVE, AJA VIDEO AND ITS VENDORS DISCLAIM IN THEIR ENTIRETY ALL OTHER WARRANTIES, EXPRESS OR IMPLIED, INCLUDING WITHOUT LIMITATION ALL WARRANTIES OF MERCHANTABILITY OR FITNESS FOR A PARTICULAR PURPOSE. AJA VIDEO'S RESPONSIBILITY TO REPAIR OR REPLACE TIMELY REPORTED DEFECTIVE PRODUCTS IS THE WHOLE AND EXCLUSIVE REMEDY CUSTOMER IS PROVIDED WITH RESPECT TO HARDWARE PRODUCTS AND THEIR STORAGE MODULES. SOME JURISDICTIONS DO NOT ALLOW THE EXCLUSION OF IMPLIED WARRANTIES OR LIMITATIONS ON APPLICABLE STATUTORY RIGHTS OF A CONSUMER, SO SOME OR ALL OF THE TERMS OF THIS PARAGRAPH MAY NOT APPLY TO YOU.

THE PRODUCT IS NOT INTENDED, STATED, OR WARRANTED TO OPERATE UNINTERRUPTED OR ERROR-FREE. YOU UNDERSTAND AND ACKNOWLEDGE THAT THE PRODUCT IS NOT INTENDED TO BE USED AS THE SOLE OR PRIMARY DATA SOURCE OR TARGET FOR CRITICAL DATA, AND THAT IT IS YOUR RESPONSIBILITY TO IMPLEMENT REDUNDANT CAPTURE AND BACKUP SYSTEMS AS APPROPRIATE.

Limitation of Liability

Under no circumstances shall AJA video BE LIABLE IN ANY WAY FOR ANY LOST, CORRUPTED OR DESTROYED DATA, FOOTAGE OR WORK, OR FOR ANY OTHER INDIRECT, SPECIAL, INCIDENTAL OR CONSEQUENTIAL DAMAGES OR LOST PROFITS, OR FOR ANY THIRD PARTY CLAIM, IN CONNECTION WITH THE PRODUCT, WHETHER RESULTING FROM DEFECTS IN THE PRODUCT, SOFTWARE OR HARDWARE FAILURE, OR ANY OTHER CAUSE WHATSOEVER, EVEN IF AJA VIDEO HAS BEEN ADVISED OF THE POSSIBILITY OF SUCH DAMAGES. AJA VIDEO'S LIABILITY IN CONNECTION WITH THE PRODUCT SHALL UNDER NO CIRCUMSTANCES EXCEED THE PURCHASE PRICE PAID FOR THE PRODUCT. The foregoing limitations apply even if any remedy set forth in this LIMITED WARRANTY fails of its essential purpose. SOME JURISDICTIONS DO NOT ALLOW THE LIMITATION OF LIABILITY FOR PERSONAL INJURY, OR OF INCIDENTAL OR CONSEQUENTIAL DAMAGES, SO SOME OR ALL OF THE TERMS OF THIS PARAGRAPH MAY NOT APPLY TO YOU.

Governing Law and Language; Your Rights.

This limited warranty is the only warranty provided by AJA Video on the hardware product. It supersedes all prior or contemporaneous understandings regarding such subject matter. No amendment to or modification of this warranty will be binding unless in writing and signed by AJA Video. The laws of the State of California, USA will govern this warranty and any dispute arising from it. Any translation of this Agreement is intended for convenience and to meet local requirements and in the event of a dispute between the English and any non-English versions, the English version of this warranty will govern. This limited warranty gives you specific legal rights and you may have other rights that vary from jurisdiction to jurisdiction, some of which are noted above.

Index

Symbols

- 2K Checkbox 42
- 2SI 57
- 2SI Mode 58
- 2-Wire Mode 58
- 3:2 Pulldown Offset 46
- 3:2 Pulldown Pattern 46
- 3Gb 38
- 3rd-Party Plugins 6
- 4K Checkbox 66
- 4K Controlled Mode 60
- 4K Mode 30
- 4K Mode Operation 57
- 4K Transport Mode 57
- 4-Wire Mode 58
- 8-Bit Video 73
- 10-Bit Video 73

A

- AES/EBU Audio I/O 13
- AJA Control Panel 6
- AJA Control Room 6
- AJA Input 68
- AJA Software & Utilities 5
- AJA Support 2
- AJA System Test 6, 17
- Analog Black 42
- Analog Monitor Level 44
- Analog Monitor Outputs 14
- Analog Output
 - Select 40
- Analog Output Connectors 13
- Analog Out Screen
 - 4K Mode 65
 - Standard Mode 40
- Application
 - Controlling KONA 28
- Audio Ch 39
- Audio Delay 44
- Audio Input 37
- Audio Mixer Screen
 - Capture Monitor Mode 70
 - Playback Monitor Mode 68
- Audio Mixer Screen Example 45, 67
- Audio Out 49
- Audio Setup 43
- Audio Setup Screen 43, 44

B

- Block Diagram Area 25
- BMP Format 24
- BNC adapter cable 8
- Breakout Cable
 - KONA 3G 12
 - KONA 4 12
- Breakout Cable Connections 12

C

- Capture Formats 24
- Colorspace 47
- Color Space 40
- Connectors
 - KONA 1 16
 - KONA 5 Card 8
- Connectors On Card
 - KONA 3G 11
 - KONA 4 11
- Controlling Application 28
- Control Panel 6, 24
 - Block Diagram Area 25
 - Conversion Icon 28
 - Framebuffer 26
 - Input/Output Icon 26
 - Preset 28
 - Primary Format 27
 - Secondary Format 27
 - UI Colors 26
 - User Interface 25
- Control Panel Control Message 71
- Control Room 6
- Control Screen
 - 4K Mode 59
 - Standard Mode 31
- Conversion Icon 28
- Conversion Screen 46
- Cross-Conversion 34
- Custom LUT Controls 51

D

- Damage in Shipping 17
- Default Output 31
- Disk Storage Methods 7
- Down Conversion 34
- Downstream Keyer Mode 48
- Downstream Keyer Screen
 - 4K Mode 71
 - Standard Mode 48
- DPX Format 24
- Dual Link 38

E

- EOTF 63
- Erase All Prefs 56
- Ext. Color 63

F

- Features
 - KONA 1 15
 - KONA 3G 10
 - KONA 4 10
 - KONA 4 Only 11
 - KONA 5 7
- Firmware Screen 56

- Firmware Update Procedure 22
- Firmware Versions 23
- Follow Input 34
- Foreground Pre-Multiplied 49
- Format Conversions 34
- Format Screen
 - 33
- Format Screen Conversion 27
- Framebuffer
 - Control Panel UI 26

G

- Gamma 47
- Genlock 32
- Geometry Checkbox 42
- Graphic File Load 49

H

- HDMI HDR Screen
 - 4K Mode, IP 63
- HDMI Output 14
 - Select 39
- HDMI Screen
 - 4K Mode 62
 - Standard Mode 39
- HDR Mode 63
- Hold Last App 32
- Host Audio 69

I

- Information Screen
 - Standard Mode 57
- Input/Output Icon 26
- Input Passthrough 31
- Input Select Screen
 - 36
- Installation
 - KONA Card 18

K

- K3G-Box 13
- KONA 1 Connectors 16
- KONA 1 Features 12, 15
- KONA 3G
 - Features 10
- KONA 3G Features 10
- KONA 4 Features 10
- KONA 4 Only Features 11
- KONA 5 Breakout Cable 8
- KONA 5 Card Connectors 8
- KONA 5 Features 7
- KONA Card
 - Installation 18
- KONA Modal Operation 30
- KONA Models 5

L

- LUT File 51, 52
- LUT File Format Specification 53
- LUT Gain and Offset Controls 52
- LUT Screen 51
- LUT Type 51

M

- Main App 68
- Matte Color 49
- Multiple AJA Devices 72
- MXF Format 24

O

- Opacity 49
- Overview 5

P

- Pause On 47
- Pixel Format 33
- Playback Source Selection 68
- Playback Timing 32
- Preferences 28
- Preference Settings 56
- Preset 28
 - Reset to Default 55
 - Transferring 55
- Presets Screen 55
- Primary 37
- Primary Format 27
- Progressive Pref 41
- Protocol 39

Q

- QT Timecode 54
- Quadrant 7
- Quadrant 2-Wire 57
- Quadrant 4-Wire 57
- Quadrant Mode 58
- Quad Swap
 - SDI Input 42
 - SDI Output 42
- QuickTime Format 24
- QuickTime Format Selection 72

R

- RED Checkbox 42
- Reference Video 15
- RGB-Full 38
- RGB Range 34, 40
- RGB-SMPTE 38
- RP-188 Timecode 54
- RS-422 Machine Control 9, 13, 16

S

- SDI
 - Video Input 36
- SDI Input Quad Swap 42
- SDI Inputs & Outputs 14

- SDI Output
 - Select 37
- SDI Output Quad Swap 42
- SDI Out Screen
 - 4K Mode 61
 - Standard Mode 37
- Secondary 38
- Secondary Format 27
- Select
 - Analog Output 40
 - HDMI Output 39
 - SDI Output 37
- Shared Preference 29
 - File Location 29
- Shipping Box Contents 17
- Software 5
- Software Conversion 46
- Software Download 21
- Software Installation 21
- Source
 - Video Input 36
- Source Gain 69
- Std Mode 30
- Stereo 38
- Stereo 3D 39
- System Connections
 - KONA 3G 20
 - KONA 4 20
- System Requirements 6
- System Test 6

T

- Technical Support 2
- Test Pattern 32
- TGA Format 24
- Third-Party Application 21
- Thunderbolt PCIe External Chassis 18
- Timecode
 - QT 54
- Timecode Burn-in 54
- Timecode Input Settings 54
- Timecode Offset 54
- Timecode Output Settings 54
- Timecode Screen 53
- Transferring Saved Presets 55
- Transport Options 38
- Two Sample Interleave 7

U

- UFC Mode 30
- Up Conversion 34
- Uploading Custom User LUT file 52
- User Bits 54
- User Preference 29
 - File Location 29
- Utilities 5

V

- VANC Checkbox 42

- Video Format (Primary and Secondary) 33
- Video Input 36
- Video+Key 38
- Video Setup Screen
 - 4K Mode 66
 - Standard Mode 41
- VOut Filters 42

Y

- YPbPr
 - Nomenclature 41
- YUV-RGB Conversion 47