

DB25 Male

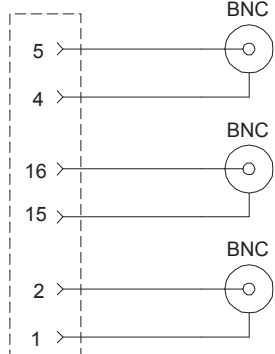

LABEL

- ▼
- Y/G
- Cb/B
- Cr/R

(GND)
(+)
(-)

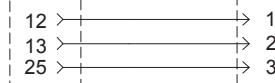

CH1 L

(GND)
(+)
(-)

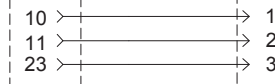

CH1 R

(GND)
(+)
(-)

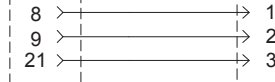

CH2 L

(GND)
(+)
(-)

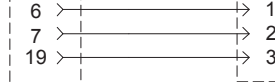

CH2 R

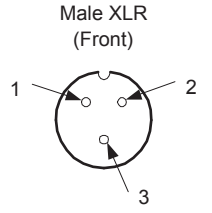
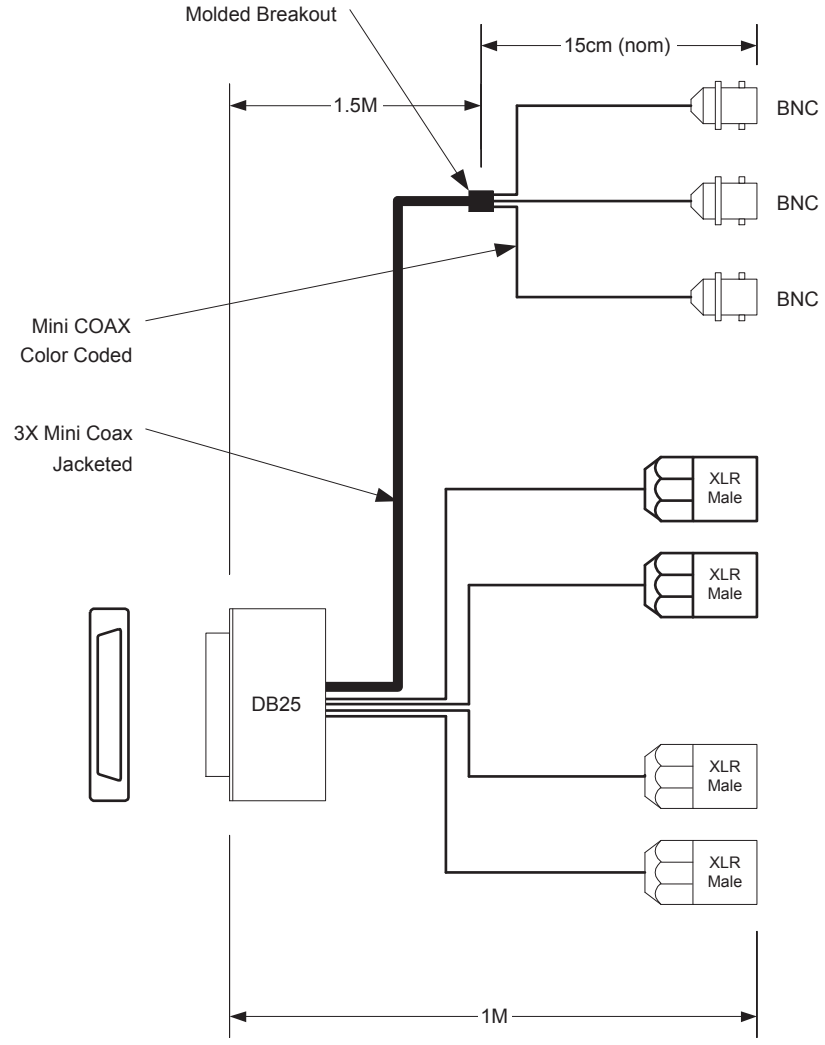

		AJA VIDEO SYSTEMS INC			
		D10CEA CABLE (BALANCED AUDIO)			
JAD	SIZE	FSCM NO	DWG NO		REV
			101226-00		
4/17/02	SCALE	NONE	SHEET	1 OF 1	