

12G-AM Mini-Converter

8-Ch Balanced Embedder/Disembedder



Installation and Operation Guide

Version 1.5r1
Published June 15, 2026



Notices

Trademarks

AJA® and Because it matters.® are registered trademarks of AJA Video Systems, Inc. for use with most AJA products. AJA™ is a trademark of AJA Video Systems, Inc. for use with recorder, router, software and camera products. Because it matters.™ is a trademark of AJA Video Systems, Inc. for use with camera products.

Corvid Ultra®, Io®, Ki Pro®, KONA®, KUMO®, ROI® and T-Tap® are registered trademarks of AJA Video Systems, Inc.

AJA Control Room™, KiStor™, Science of the Beautiful™, TruScale™, V2Analog™ and V2Digital™ are trademarks of AJA Video Systems, Inc.

All other trademarks are the property of their respective owners.

Copyright

Copyright © 2026 AJA Video Systems, Inc. All rights reserved. All information in this manual is subject to change without notice. No part of the document may be reproduced or transmitted in any form, or by any means, electronic or mechanical, including photocopying or recording, without the express written permission of AJA Video Systems, Inc.

Contacting AJA Technical Support or Sales

Please have all pertinent information at hand prior to contacting AJA support or sales.

Support Telephone: +1.530.271.3190

Support Website: <https://www.aja.com/support/contact>

Support Email: support@aja.com

Sales Email: sales@aja.com

Shipping Address: AJA Video Systems
180 Litton Drive
Grass Valley, CA 95945, USA

Contents

Notices	2
Trademarks	2
Copyright	2
Contacting AJA Technical Support or Sales	2
Chapter 1 – Introduction	4
Overview	4
Base Model	4
Fiber Options	4
Features	5
12G-AM Simplified Block Diagram	5
12G-AM I/O Connections	6
User Controls	6
DIP Switches	6
Mini-Config Control	7
Installation	7
Breakout Cable Pinouts	8
Chapter 2 – Operation	10
Default Operational Settings	10
DIP Switches	10
DIP Switch Settings	10
Switch 6 Embedded Channel Mapping	11
Switch 7 Disembedding Channel Mapping	12
USB Control and Setup—Using AJA Mini-Config	12
Acquiring Mini-Config	12
Installing Mini-Config	13
Running Mini-Config	14
Operating Mini-Config	15
Tabbed Screens	16
Input Tab Screen	17
Audio-1 Tab Screen	18
AES Audio Inputs	19
AES Audio Outputs	19
Audio-2 Tab Screen	20
Packet Processing Control	20
SRC	20
About SRC Settings	21
Update Tab Screen	21
Info Tab Screen	22
Appendix A – Specifications	24
12G-AM Family Tech Specs	24
Appendix B – Safety and Compliance	27
5-Year Warranty and Liability Information	36
AJA Software License Agreement	37
Index	40

Chapter 1 – Introduction



Overview

The 12G-AM is an 8 channel AES audio embedder/disembedder. AES audio can be embedded and disembedded simultaneously. The embedder is user selectable, on a channel pair basis, to either “pass” existing SDI input audio or embed AES input audio from the breakout cable. The ability to pass incoming ancillary data makes it possible to embed up to 16 channels of audio by cascading two units. Horizontal ancillary data (HANC) packets in compliance with SMPTE 291M can also be dropped at the input.

The 12G-AM automatically detects and configures to the input video standard. It supports 12G-SDI input and output up to 4K/UltraHD single link, with fiber I/O options (see "[Appendix A Specifications](#)" on page 24 for a complete listing). SDI video loops through the device with minimal delay. Loop through embedded SDI audio supports up to 16 channels.

NOTE: 2048x1080p/psf 29.97 and 30 formats support a maximum of 8 channels embedded audio.

The 12G-AM ships with a four in, four out XLR connector AES breakout cable. An optional BNC breakout cable (CBL DB25-8BNC) is also available.

Using the Mini-Config application, you can configure data packets to be passed from the AES inputs to embedded ancillary packets un-altered. This, along with minimized embed/disembed latency, ensures 100 percent compatibility with Dolby® bitstreams.

Base Model

The base model—12G-AM—does not include a fiber SFP module.

Fiber Options

Five variations of the 12G-AM include LC or ST fiber options:

LC Options

- 12G-AM-T, includes a 1310 nm Single Mode optical transmitter, Tx 1260 nm (min), 1310 nm (typ), 1360 nm (max)

- 12G-AM-R, includes a 1260 nm (min), 1620 nm (max) Single Mode optical receiver
- 12G-AM-TR, includes a 1260 nm (min), 1620 nm (max) Single Mode optical receiver, and a 1260 nm (min), 1310 nm (typ), 1360 nm (max) Single Mode optical transmitter

ST Options

- 12G-AM-T-ST, includes a 1260 nm (min), 1310 nm (typ), 1360 nm (max) Single Mode optical transmitter
- 12G-AM-R-ST, includes a 1260 nm (min), 1620 nm (max) Single Mode optical receiver

Features

- 12G, 6G, 3G, HD, and SD-SDI embedder/disembedder
- 8 Channel AES I/O
- Supplied AES breakout cable, XLR or optional BNC
- 1 x BNC 3G-SDI input
- 1 x BNC 3G-SDI output
- 1x 12G-SDI Fiber ST input (dual SFP port)
- 1x 12G-SDI Fiber ST output (dual SFP port)
- Setup via DIP switch or PC/Mac using USB port and supplied USB cable (Mini-Config configuration software application available via download from AJA website)
- Uses universal input +5V power supply AJA model DWP-U-R1 (included)

12G-AM Simplified Block Diagram

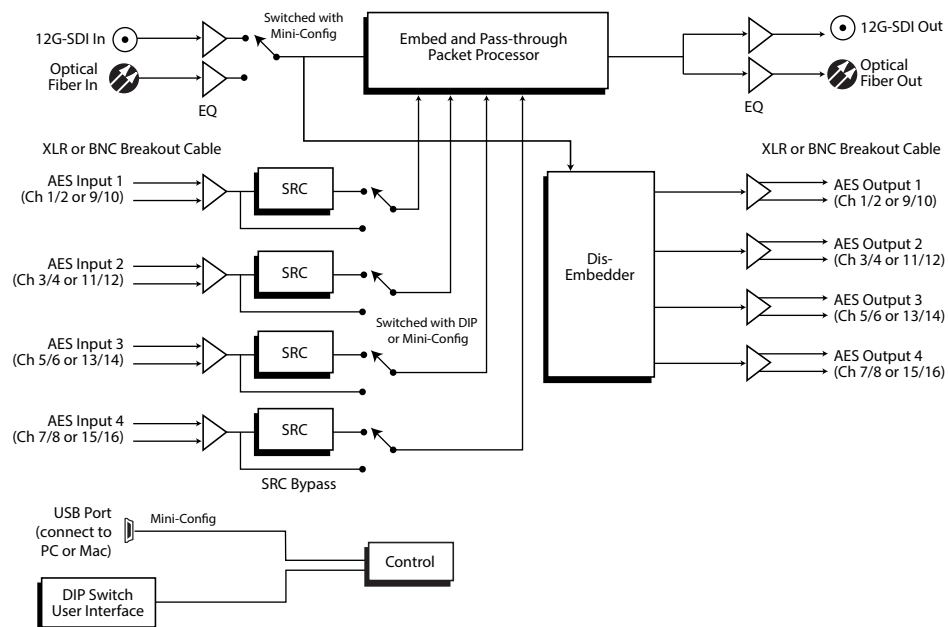

12G-AM I/O Connections



NOTE: The LOCK LED indicates valid input video by color. Off is no signal, green is SD video, red is HD video, amber is 3G video, blue is 4K/UltraHD.

User Controls

DIP Switches

The 12G-AM has an 8 position DIP switch accessible through a cut-out in the bottom of the unit. The DIP switches are used to configure the unit's audio embedding and disembedding, and control ancillary data.

Figure 1. 12G-AM DIP Switches and Label

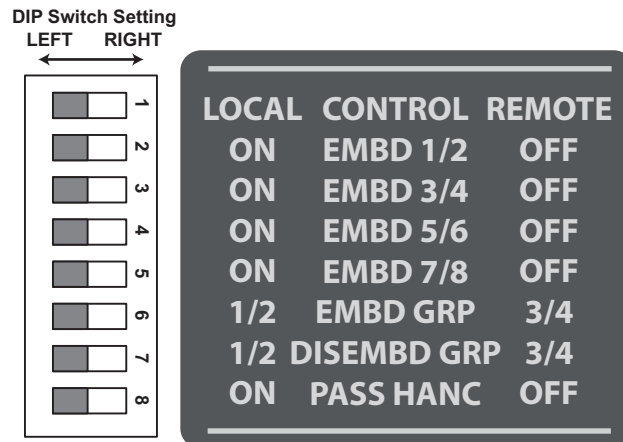

Factory default switch settings are all in the leftmost position.

The exact functions of the DIP switches are described in "[DIP Switch Settings](#)" on [page 10](#)

Mini-Config Control

The Mini-Config application can also be used to configure the unit's audio embedding and disembedding functions. Configuration set via Mini-Config is stored in the unit through subsequent power cycles.

Installing and using Mini-Config are described in "[USB Control and Setup—Using AJA Mini-Config](#)" on [page 12](#).

Installation

Typically, 12G-AM installation consists of the following steps:

1. Ensure the converter is disconnected from power.
2. Connect video equipment to the converter BNCs.
3. If applicable, connect fiber to the 12G-SDI Fiber single channel SFP receiver, transmitter or transceiver.



Warning! Active fiber-optic cables emit radiation invisible to the human eye. Do not look directly at the end of an active fiber-optic cable or the fiber connector on a 12G-AM-R, 12G-AM-R-ST, 12G-AM-T, 12G-AM-T-ST, or 12G-AM-TR; these models are Class 1 Laser Products.

Figure 2. 12G-AM to Fiber LC Single Channel SFP Example



NOTE: Fiber optic interconnections can be severely compromised by dirt, oils, or other contaminants. All dust caps should be replaced on cables and equipment whenever 12G-AM converters are disconnected from fiber optic cables.

4. Connect the breakout audio cable to the converter.
5. Connect audio equipment to the breakout cable.
6. Apply power to the converter (AJA power supply included).

7. The converter will now run using the default factory settings. If you wish to alter the factory settings you can either:
 - Change the DIP switch 2 - 8 settings.
 - or -
 - Install the AJA Mini-Config software on your computer,
 - attach the converter via USB,
 - change the DIP switch 1 setting to LOCAL, and
 - make your changes using the Mini-Config setup screens.

NOTE: For highest reliability, the mini-converter relies on convection cooling instead of using a built-in fan. Therefore, when installing the unit, mount in a location where it has access to air for proper cooling. Do not stack the 12G-AM with other mini converters.

Breakout Cable Pinouts

Figure 3. AES Breakout Cable Illustration, XLR Connectors

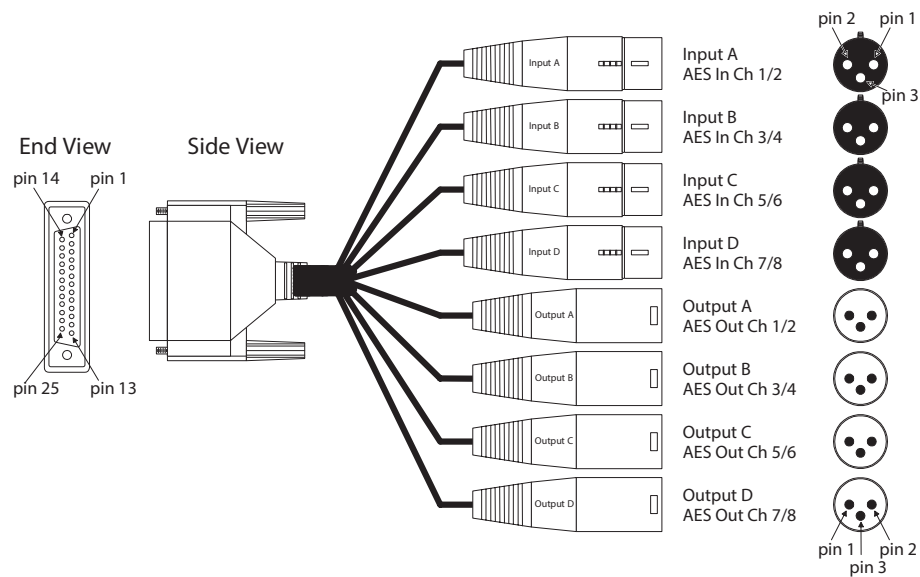

Table 1. XLR DB25 Breakout Cable Pinouts

Pin	Function	Pin, <connector>	Pin	Function	Pin, <connector>
1	In 4 +	2, XLR Input D	14	In 4 -	3, XLR Input D
2	In 4 GND	1, XLR Input D	15	In 3 +	2, XLR Input C
3	In 3 -	3, XLR Input C	16	In 3 GND	1, XLR Input C
4	In 2+	2, XLR Input B	17	In 2 -	3, XLR Input B
5	In 2 GND	1, XLR Input B	18	In 1 +	2, XLR Input A
6	In 1 -	3, XLR Input A	19	In 1 GND	1, XLR Input A
7	Out 4 +	2, XLR Output D	20	Out 4 -	3, XLR Output D
8	Out 4 GND	1, XLR Output D	21	Out 3 +	2, XLR Output C
9	Out 3 -	3, XLR Output C	22	Out 3 GND	1, XLR Output C
10	Out 2 +	2, XLR Output B	23	Out 2 -	3, XLR Output B
11	Out 2 GND	1, XLR Output B	24	Out 1 +	2, XLR Output A
12	Out 1 -	3, XLR Output A	25	Out 1 GND	1, XLR Output A
13	NC	NC			

Figure 4. AES Breakout Cable Illustration, BNC Connectors

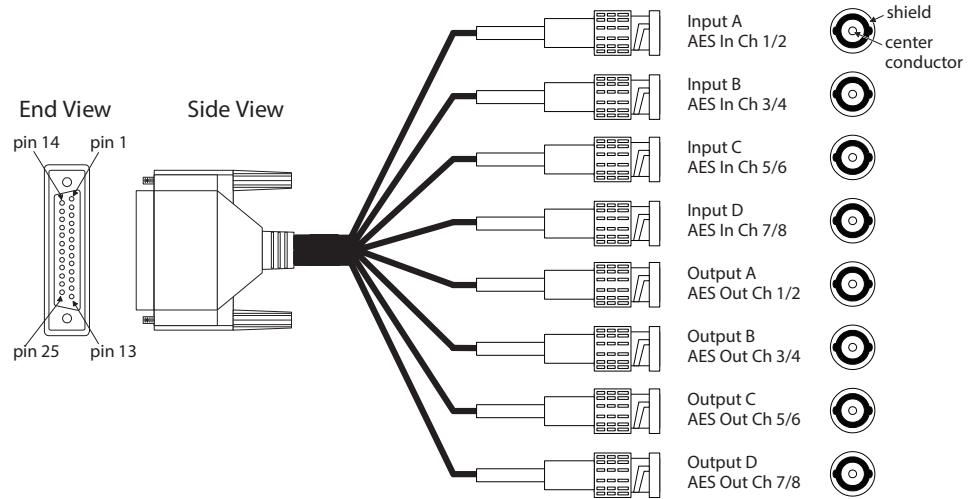

Table 2. BNC DB25 Breakout Cable Pinouts

Pin	Function	Pin, <connector>	Pin	Function	Pin, <connector>
1	In 4 +	center, AES In 7/8	14	In 4 -	NC
2	In 4 GND	shield, AES In 7/8	15	In 3 +	center, AES In 5/6
3	In 3 -	NC	16	In 3 GND	shield, AES In 5/6
4	In 2+	center, AES In 3/4	17	In 2 -	NC
5	In 2 GND	shield, AES In 3/4	18	In 1 +	center, AES In 1/2
6	In 1 -	NC	19	In 1 GND	shield, AES In 1/2
7	Out 4 +	center, AES Out 7/8	20	Out 4 -	NC
8	Out 4 GND	shield, AES Out 7/8	21	Out 3 +	center, AES Out 5/6
9	Out 3 -	NC	22	Out 3 GND	shield, AES Out 5/6
10	Out 2 +	center, AES Out 3/4	23	Out 2 -	NC
11	Out 2 GND	shield, AES Out 3/4	24	Out 1 +	center, AES Out 1/2
12	Out 1 -	NC	25	Out 1 GND	shield, AES Out 1/2
13	NC	Jumper to DB-25 pin 11			

Chapter 2 – Operation

Default Operational Settings

The 12G-AM converter ships from the factory with the following configuration:

- Local (DIP switch) control.
- BNC input.
- Input AES audio channel pairs 1/2, 3/4, 5/6, 7/8 are embedded to SDI output channel pairs 1/2, 3/4, 5/6, 7/8, overwriting any existing embedded audio.
- Input SDI embedded audio channel pairs 1/2, 3/4, 5/6, 7/8 are disembedded to AES audio output channels 1/2, 3/4, 5/6, 7/8.
- All HANC packets pass from SDI input to output, except for embedded output audio channels 1/2, 3/4, 5/6, 7/8.

If these settings apply to your requirements, you can simply connect the video and audio input and output signal cables and power up the unit.

For other applications, you can configure the unit using its DIP switch settings, or by using the Mini-Config application and a PC or Mac via USB.

DIP Switches

The 12G-AM DIP switches configure the audio embedding and disembedding functions, and control ancillary data.

DIP Switch Settings

DIP switch settings used to configure various functions are described below.

Table 3. 12G-AM DIP Switch Setting Descriptions

SWITCH	FUNCTION	DIP Set LEFT (default)	DIP Set RIGHT
1	Control	Selects Local (DIP), and blocks Mini-Config control.	Selects Remote (Mini-Config), and disables DIP switches 2-8.
2	Audio Embedding for Channels 1/2 (EMBD 1/2)	(ON) Overwrite or embed new channel 1/2 packets.	(OFF) If AUX (SW 8) is ON: Pass any channel 1/2 packets from input SDI. If AUX (SW 8) is OFF: Delete all packets from input SDI.
3	Audio Embedding for Channels 3/4 (EMBD 3/4)	(ON) Overwrite or embed new channel 3/4 packets.	(OFF) If AUX (SW 8) is ON: Pass any channel 3/4 packets from input SDI. If AUX (SW 8) is OFF: Delete all packets from input SDI.
4	Audio Embedding for Channels 5/6 (EMBD 5/6)	(ON) Overwrite or embed new channel 5/6 packets.	(OFF) If AUX (SW 8) is ON: Pass any channel 5/6 packets from input SDI. If AUX (SW 8) is OFF: Delete all packets from input SDI.
5	Audio Embedding for Channels 7/8 (EMBD 7/8)	(ON) Overwrite or embed new channel 7/8 packets.	(OFF) If AUX (SW 8) is ON: Pass any channel 7/8 packets from input SDI. If AUX (SW 8) is OFF: Delete all packets from input SDI.
6	Channel Mapping For Embedded Groups (EMBD GRP)	Embed to Groups 1/2 as specified in 272M and 299M Refer to "DIP SW 6 Embedded Channel Mapping" on page 11.	Embed to Groups 3/4 as specified in 272M and 299M

7	Channel Mapping For Disembedding Groups (DISEMBD GRP)	Disembed from Groups 1/2 as specified in 272M and 299M)	Disembed from Groups 3/4 as specified in 272M and 299M
		Refer to " DIP SW 7 Disembedded Input Channel Mapping " on page 12.	
8	Pass or Drop HANC input packets. (PASS HANC)	(ON) All incoming HANC packets are passed unless the embedder settings above require all or part of them to be over-written.	(OFF) All incoming HANC packets are dropped before embedding any new audio packets. Embedder settings above determine all embedded audio output. Disembedding is not affected.

NOTE: 2048x1080p/psf 29.97 and 30 formats support a maximum of 8 channels of embedded audio. When one of these formats is present and embedding is turned on, the PASS HANC DIP switch will be ignored and all incoming packets will be dropped before embedding any new audio packets.

Switch 6 Embedded Channel Mapping

The following table shows how switch 6 affects embedded channel mapping.

Table 4. DIP SW 6 Embedded Channel Mapping

DIP SW 6 EMBD GRP	AES Input Channel	SDI Embedded Group	SDI Embedded Output Channel
Left (1/2)	1 →	1	1
	2 →		2
	3 →		3
	4 →		4
	5 →	2	5
	6 →		6
	7 →		7
	8 →		8
Right (3/4)	1 →	3	9
	2 →		10
	3 →		11
	4 →		12
	5 →	4	13
	6 →		14
	7 →		15
	8 →		16

Switch 7 Disembedding Channel Mapping

The following table shows how switch 7 affects disembedding channel mapping.

Table 5. DIP SW 7 Disembedded Input Channel Mapping

DIP SW 7 DISEMBD GRP	SDI Embedded Channel	SDI Embedded Input Group	AES Output Channel
Left (1/2)	1	1 →	1
		2 →	2
		3 →	3
		4 →	4
	2	5 →	5
		6 →	6
		7 →	7
		8 →	8
Right (3/4)	3	1 →	1
		2 →	2
		3 →	3
		4 →	4
	4	5 →	5
		6 →	6
		7 →	7
		8 →	8

USB Control and Setup—Using AJA Mini-Config

Your AJA Mini-Converter can be used right out of the box for some applications since it is designed to recognize inputs and perform standard actions automatically by default. However, to use its full capability, you must use AJA's Mini-Config software application for PCs and Macs. This same application can be used to update to new Mini-Converter software released by AJA.

NOTE: DIP switch 1 must be ON (Remote, Right) to permit Mini-Config control of the unit.

Acquiring Mini-Config

AJA's Mini-Config application is available for download from the AJA website.

To download the latest Mini-Config package, which includes the Mini-Config application, Mini-Converter firmware, and documentation, go to:

<https://www.aja.com/products/mini-converters/mini-config-software>

Select either the Windows or Mac icon to download the desired version.

Mini-Converter Documentation

Included with the Mini-Config package is a complete set of documentation for all Mini-Converters supported by Mini-Config. A .PDF of the *Installation and Operation Guide* for the currently connected Mini-Converter can be accessed from the Mini-Config UI via the **Help/Manual** drop-down menu.

Documentation for all AJA Mini-Converters that use Mini-Config can also be accessed directly in the Mini-Config download package Documentation folder, and via the Documentation icon available on the Mac installer.

Documentation (and firmware) included with the Mini-Config application are the versions available at the time of distribution. However, Mini-Converter software, firmware and documentation are updated regularly, so newer versions may exist.

To download the latest documentation for an individual Mini-Converter, go to:

<https://www.aja.com/category/mini-converters>

and navigate to the Support web page of that Mini-Converter.

Installing Mini-Config

PC Installation

To install Mini-Config on a Windows PC:

1. Download the application from the AJA website (select the Windows icon on the Mini-Config Support web page).
2. Open the AJA_MiniConfig.zip file
3. Double-click on the **MiniInstaller.msi** file.
4. A Setup Wizard will guide you through the installation.

Figure 5. Mini-Config PC Setup Wizard

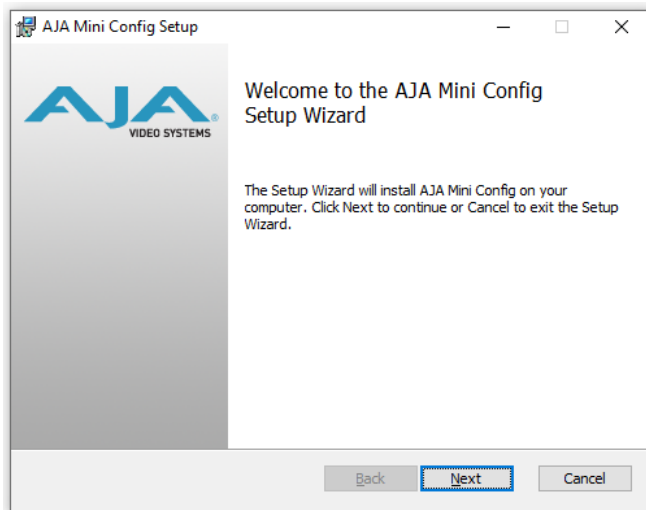

5. Click **Next** to begin. Answer the questions in the subsequent dialogs. When finished, an AJA Mini-Config shortcut will be installed on the desktop, and you will be able to locate the Mini-Config application in the AJA folder in the Programs listing.

NOTE: If the Mini-Config application already exists on the PC, a different Setup Wizard appears.

Figure 6. Mini-Config Setup Wizard, Reinstallation

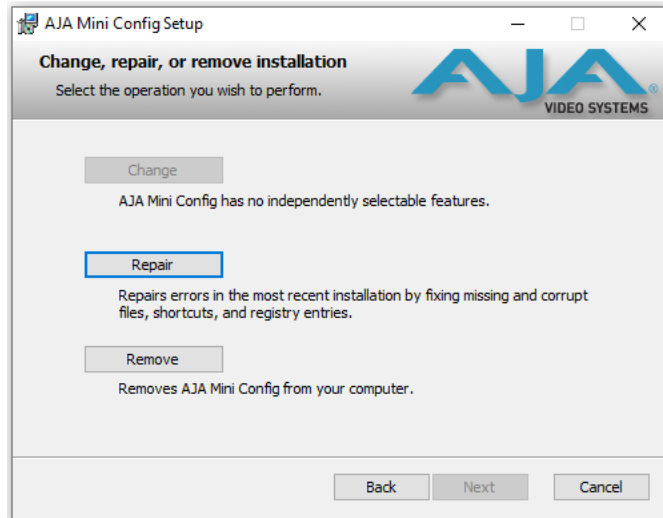

With this screen you can **Repair** (reinstall) or **Remove** (uninstall) Mini-Config on the PC.

Mac Installation

To install the application on a Mac:

NOTE: Mac computers must be Intel-based (G5, G4 and earlier models will not work with Mini-Config).

1. Download the application from the AJA website (select the Apple icon on the Mini-Config Support web page).
2. Open the AJA_MiniConfig folder.
3. Double-click on the **AJAMiniConfig.dmg** file.
4. Answer the prompt and a utility program will be launched.

Figure 7. Mini-Config Mac Installer

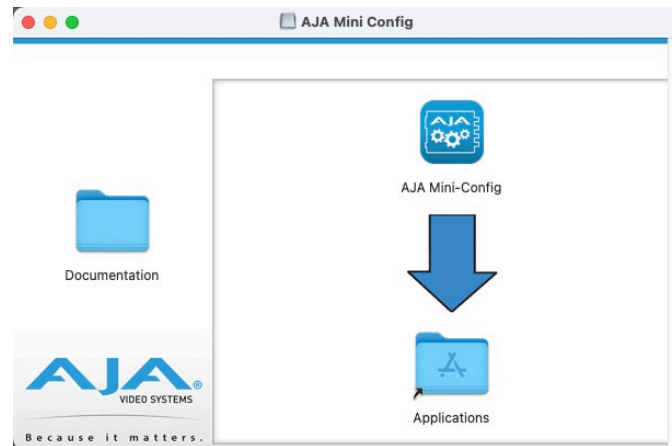

5. To complete the installation drag the **MiniConfig.app** icon to the Applications folder.

Running Mini-Config

Connect the Mini-Converter to the PC or Mac via the supplied USB cable. Connect the external power supply (supplied) to the Mini-Converter.

PC Startup

To run Mini-Config on a PC, double-click on the AJA Mini-Config icon on your desktop, or open the AJA folder in the program list and click on the AJA Mini-Config application located inside the Mini-Config folder.

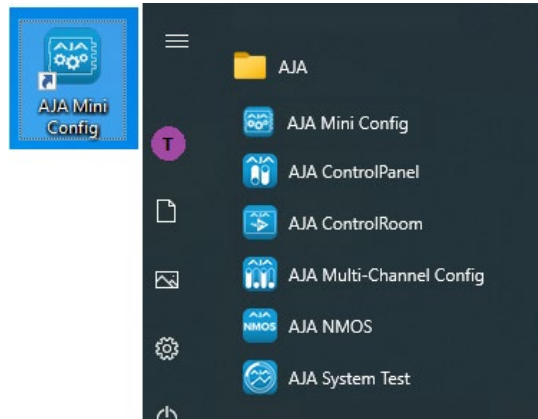

Mac Startup

To run Mini-Config on a Mac, open the Applications folder and locate the AJA Mini-Config application. Double-click the application to launch it.

Saving Setups

A **File** drop-down menu on the Mini-Config application bar (similar for Mac and PC) allows you to save the current state of the Mini-Converter to a preset file for later recall.

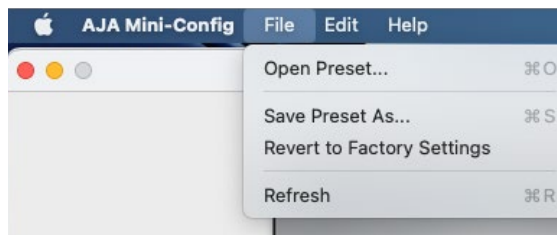

Using this feature you can set up the converter for different applications, storing each configuration (**Save Preset As...**) with a unique name for easy recall (**Open Preset...**).

A **Revert to Factory Settings** menu item similarly allows you to change the settings back to AJA's factory defaults.

Operating Mini-Config

The Mini-Config application provides a graphic interface for viewing settings and updating software. It consists of an information area at the top that shows the available Mini-Converters attached to the computer via USB, with a graphical rendering of the selected Mini-Converter showing all the connectors and their current state.

Colored text next to the connectors indicates the signal type and what the Mini-Converter is doing:

- Blue text indicates the values automatically selected
- Black text indicates values that you have manually selected

- Red text indicates the Mini-Converter is not detecting a signal, or cannot operate with the current user settings.

NOTE: Even if no output device is detected, the SDI connector text still shows the signal it is outputting.

NOTE: Configuration settings in red will change based on the attached output device as well as input signals. For improved accuracy and reliability, you should configure the Mini-Converter only when the target output device is attached and input signals are supplied at the inputs.

Screens are virtually the same on both PC and Mac, with subtle differences that reflect the general look of the platform environment.

Figure 8. Example Mini-Config Screen

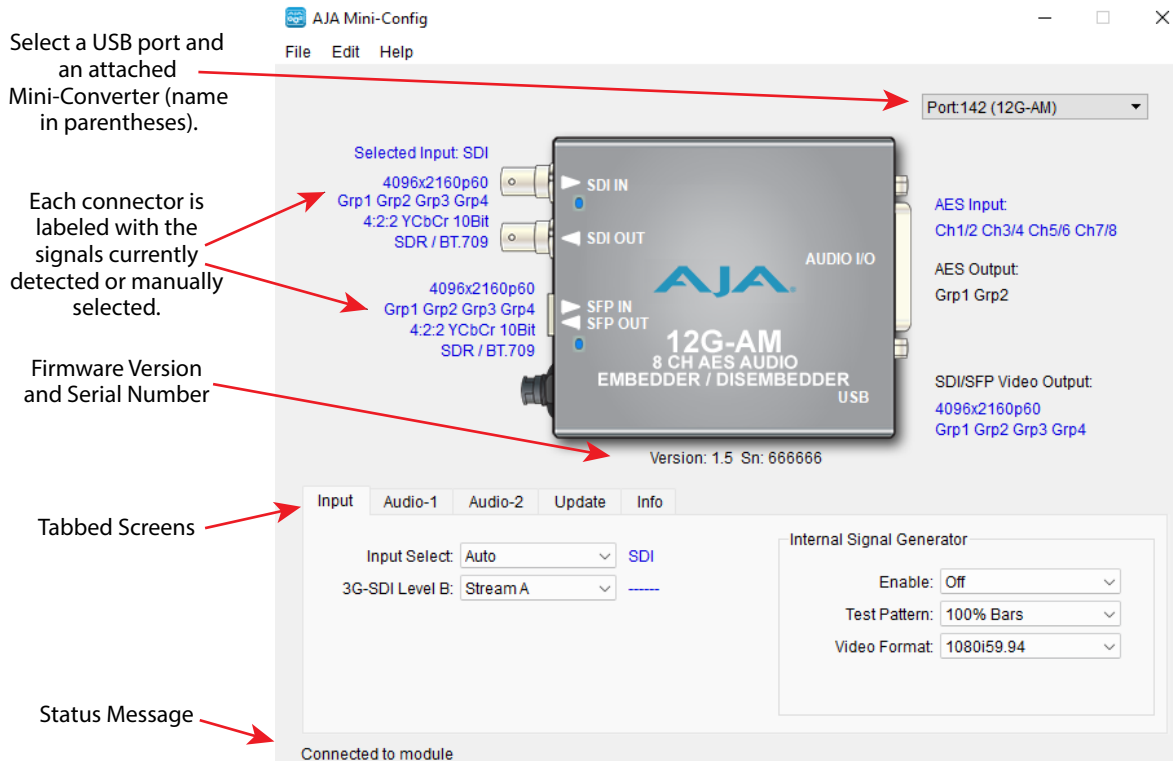

Selecting a Mini-Converter with the drop-down menu causes this application to connect to the selected converter. The graphic of Mini-Converter and text below it provides:

- Type of converter
- Firmware version
- Serial number of the unit.

A status field at the bottom of the screen shows if your application is connected and communicating with the Mini-Converter.

When configuring the Mini-Converter, select it from the top drop-down, view the current settings and change any values. Making a change communicates that new value to the Mini-Converter's non-volatile memory.

Tabbed Screens

The Tabs delineate control screens with groups of controls for each type of task to be performed.

The controls for the actual configuration parameters are specific to each Mini-Converter type. When you Click on any of the tab buttons, the pane below the tabs will change to match your tab selection. Any changes you make are immediately applied and will be saved, overwriting previous settings.

Input Tab Screen

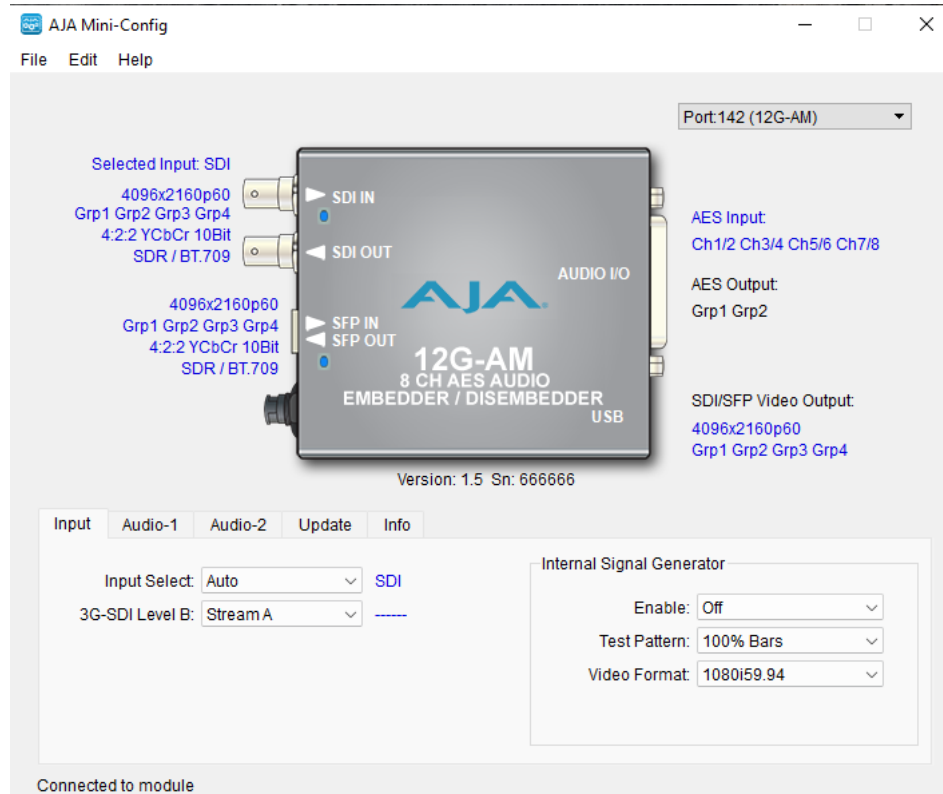

Click on the Input tab to select the input source and Level B-DS (Dual Stream) level configuration.

Input Select

Select the active video source:

- Auto - Automatically selects between the SDI Input and the Optical Input
- SFP - Selects the optical input (via SFP)
- SDI - Selects the SDI input

3G-SDI Level B:

When a 3G-SDI Level B-DS (Dual Stream) signal is detected, use this control to select which input video stream the unit will disembed audio from—Stream A or Stream B. This setting also controls whether output video Stream A or Stream B will receive embedded audio.

NOTE: This control has no effect if a 3G-SDI Level B-DS signal is not detected.

Internal Signal Generator

The Internal Signal Generator allows the 12G-AM to output a 1.5G SDI video with embedded audio without an SDI input signal present. Otherwise, if no input video signal is present, audio will not be available to embed on the SDI output.

NOTE: The Internal Signal Generator supersedes the input video signal. Make sure it is turned off when an input signal is present.

Enable

Select On or Off (Off by default).

Test Pattern

Select from available options:

- Black (default)
- 100% Color Bars
- Grey

Video Format

Select from available options:

- 720p50
- 720p59.94
- 1080i50
- 1080i59.94

Audio-1 Tab Screen

The screenshot shows the AJA Mini-Config software window. At the top, it displays 'AJA Mini-Config' and a menu with 'File', 'Edit', and 'Help'. The main area features a central image of the 12G-AM module with various ports labeled: 'Selected Input: SDI' (4096x2160p60, Grp1 Grp2 Grp3 Grp4, 4:2:2 YCbCr 10Bit, SDR / BT.709), 'SDI IN', 'SDI OUT', 'SFP IN', 'SFP OUT', 'AES Input' (Ch1/2 Ch3/4 Ch5/6 Ch7/8), 'AES Output' (Grp1 Grp2), and 'SDI/SFP Video Output' (4096x2160p60, Grp1 Grp2 Grp3 Grp4). A dropdown menu at the top right is set to 'Port:142 (12G-AM)'. Below the module image, there are tabs for 'Input', 'Audio-1', 'Audio-2', 'Update', and 'Info'. The 'Audio-1' tab is active, showing 'AES Audio Inputs' and 'AES Audio Outputs' settings. The 'AES Audio Inputs' section includes 'Embed to: Groups 1/2' and four 'Embed' options (Ch 1/2, 3/4, 5/6, 7/8), all set to 'On'. The 'AES Audio Outputs' section includes 'Disembed from: Groups 1/2'. At the bottom, it indicates 'Connected to module'.

Click on the Audio-1 tab to view and make changes to the audio embedding and disembedding settings.

AES Audio Inputs

Embed to:

Choose which SDI embedded audio groups will embed incoming AES audio.

Select from:

- Groups 1/2 (Ch 1-8)
- Groups 3/4 (Ch 9-16).

Ch1-2 Embed:

- On embeds AES audio Ch 1/2 pair in the first two channels of the Groups selected above.

Ch 3-4 Embed:

- On embeds AES audio Ch 3/4 pair in the next two channels of the Groups selected above.

Ch 5-6 Embed:

- On embeds AES audio Ch 5/6 pair in the next two channels of the Groups selected above.

Ch 7-8 Embed:

- On embeds AES audio Ch 7/8 pair in the last two channels of the Groups selected above.

AES Audio Outputs

Disembed from:

Choose which SDI embedded audio group will disembed its audio and send it to the four AES audio outputs. Select from:

- Group 1/2 (Ch 1-8)
- Group 3/4 (Ch 9-16).

Audio-2 Tab Screen

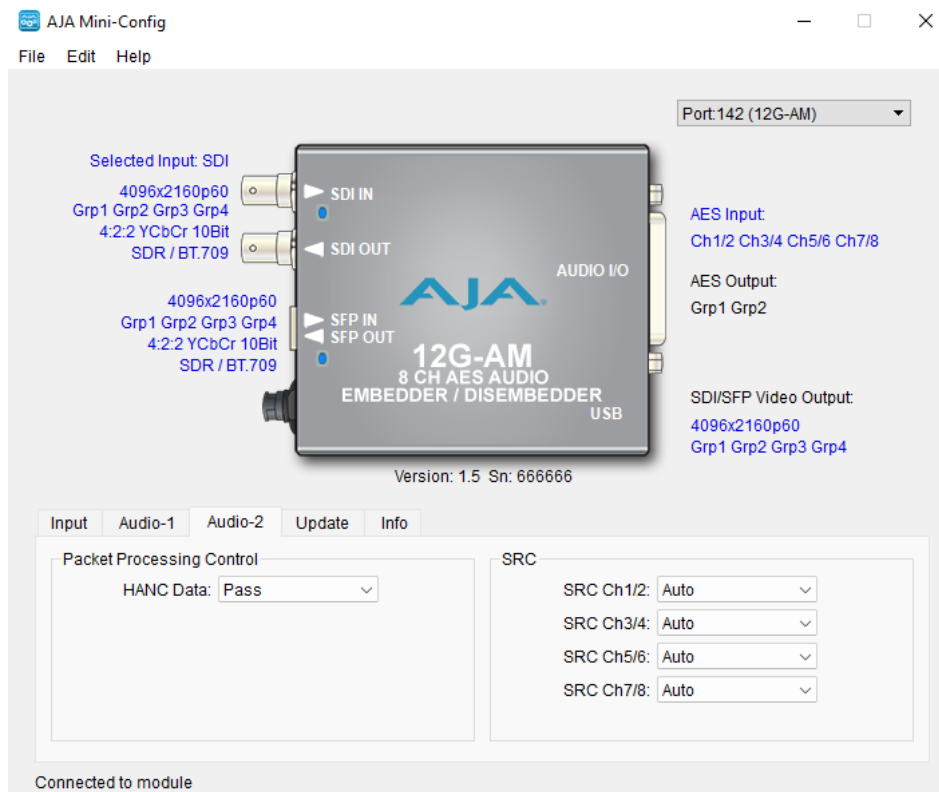

Click on the Audio-2 tab to view and make changes to the packet processing and audio level settings.

Packet Processing Control

HANC Data:

- Pass - All incoming HANC packets are passed unless the embedder settings require all or part of them to be over-written.
- Remove - All incoming HANC packets are dropped before embedding any new audio packets. The embedder settings determine all embedded audio output. Disembedding is not affected.

NOTE: 2048x1080p/psf 29.97 and 30 formats support a maximum of 8 channels of embedded audio. When one of these formats is present and embedding is turned on, the PASS HANC setting will be ignored and all incoming packets will be dropped before embedding any new audio packets.

SRC

This setting determines whether AES audio inputs are passed through the sample rate converter before embedding. Turn this setting Off for compatibility with non-PCM bitstreams such as Dolby-E or Dolby-B.

Choose Auto, On, or Off for each of the indicated input channel pairs: (Ch 1/2, Ch 3/4, Ch 5/6, Ch 7/8).

- Auto - Automatically selects whether incoming AES audio is sample rate converted. If channel status bits are detected that indicate the audio is PCM (normal digital audio), the audio will be passed through the sample rate

converter. If compressed audio (such as Dolby) bits are detected, the sample rate converter is bypassed (it would corrupt the compressed data).

- On - Pass all input AES audio through the sample rate converter before embedding (for example, for use with PCM audio). AES inputs are sample rate converted to a 48KHz rate synchronous to the video input.
- Off - Do not pass any input AES audio through the sample rate converter before embedding (for example, for use with Dolby® Digital from a synchronous source).

NOTE: For proper operation with SRC Off, the AES input timing must be externally synchronized to the input SDI.

About SRC Settings

48KHz synchronous ancillary packets are disembedded and passed unaltered to the AES outputs regardless of the SRC setting. With the SRC setting Off, data packets are passed from the AES inputs to embedded ancillary packets unaltered, according to SMPTE 337M. All AES3-2003 defined channel status bits are passed through unaltered in both the embed and dis-embed directions—except for the sample rate field, which is always set to 48KHz. The channel status CRC is re-calculated and inserted into the bitstream. This ability, along with a very small audio embed/disembed latency, ensures 100 percent compatibility with Dolby® bitstreams.

Update Tab Screen

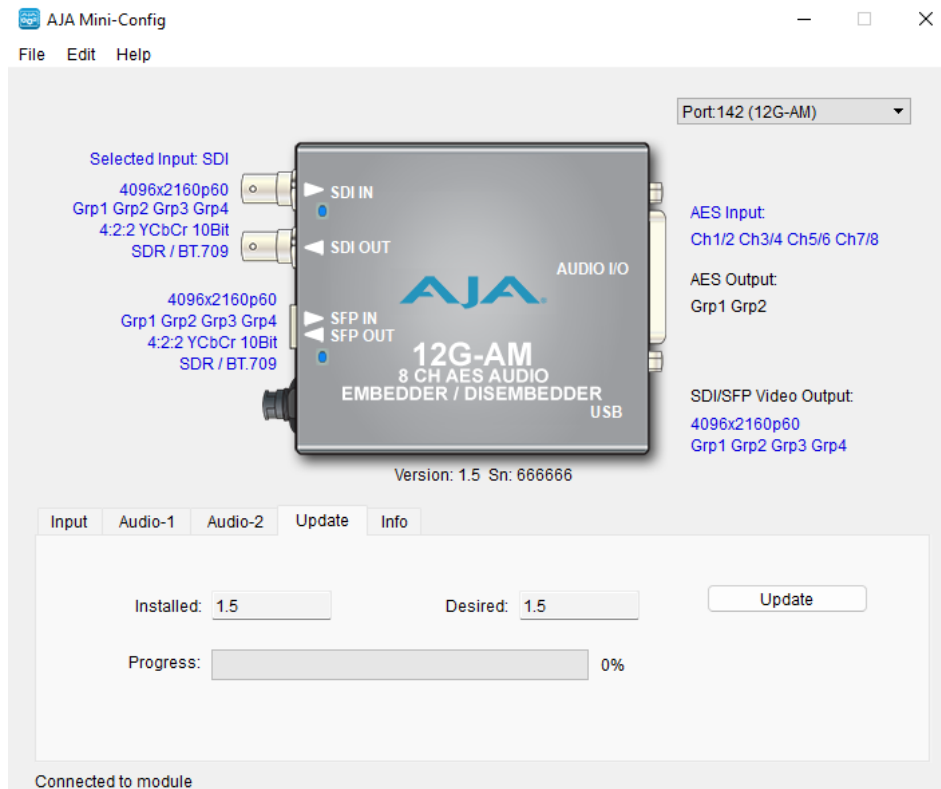

Use this Update tab screen to view the software version currently installed on the converter or install new software.

NOTE: When discussing Mini-Converters, “Firmware” is software that will be stored in the Mini-Converter’s non-volatile memory and used when it is powered up. This is something different than the Mini-Config application software. The version numbers shown in the Update screen refer only to the firmware.

Installed

This field shows the version of the firmware currently installed inside the Mini-Converter.

Desired

This field shows the version of firmware embedded in the Mini-Config application which you can install into the Mini-Converter by clicking the Update button.

Update

This button initiates a software update operation loading the “Desired” version of firmware into the Mini-Converter’s non-volatile memory.

Progress

This indicator bar shows the progress of firmware installation.

See ["Acquiring Mini-Config" on page 12](#) and ["Installing Mini-Config" on page 13](#) for more information.

Info Tab Screen

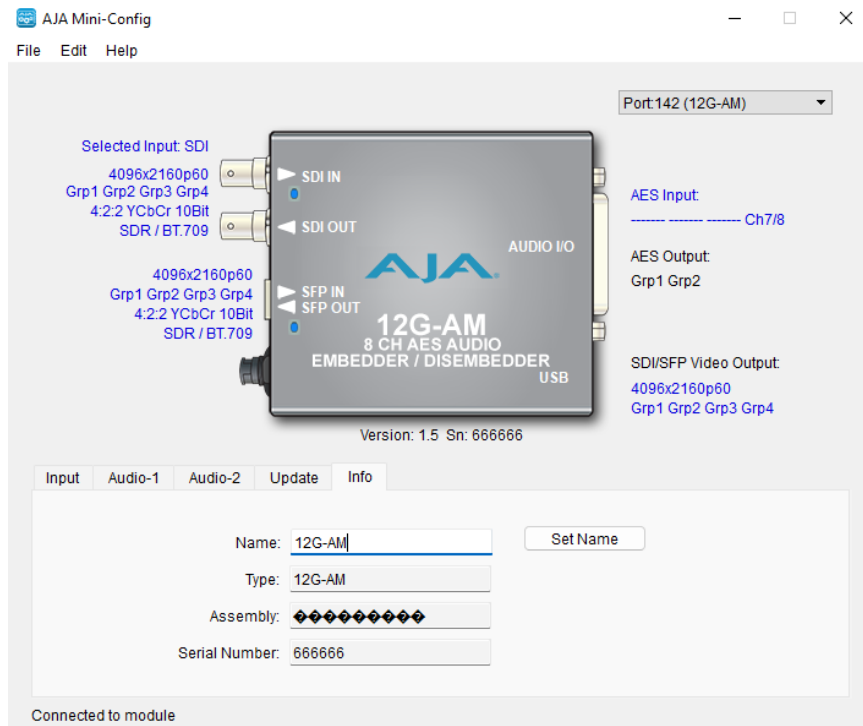

This screen provides basic information about the Mini-Converter. This information is mostly useful when calling AJA Support for service or technical support.

Name

This field allows you to give your Mini-Converter a name. This can be useful if you have several Mini-Converters attached to a Mac/PC via USB so you can distinguish between them easily (especially if they're the same model). Click Set Name to apply new name.

Type

This is the factory set model name of the Mini-Converter.

Assembly

This is the factory assembly number.

Serial Number

This is the factory set unique serial number of your Mini-Converter. If you ever call AJA Support for service, you may be asked for this number.

Appendix A – Specifications

12G-AM Family Tech Specs

Video Formats

- (4K) 4096x2160p 23.98, 24, 25, 29.97, 30, 47.95, 48, 50, 59.94, 60
- (UltraHD) 3840x2160p 23.98, 24, 25, 29.97, 30, 50, 59.94, 60
- (2K) 2048x1080p 23.98, 24, 25, 29.97, 30, 47.95, 48, 50, 59.94, 60
- (HD) 1920x1080p 23.98, 24, 25, 29.97, 30, 50, 59.94, 60
- (HD) 1920x1080i 50, 59.94, 60
- (HD) 1280x720p 50, 59.94, 60
- (SD) 625i 50
- (SD) 525i 59.94
- RGB and YCbCr, 4:4:4/2:2, 10-bit

Note: Raster and frame rate dependent. Please see 12G-AM Video Formats in Documents and Manual.

Video Input Digital

- 1x 12G-SDI BNC, SMPTE 259/292/424/2081/2082
 - Single Link SD/HD/2K/UltraHD/4K
 - Single Link 3G-SDI Level A or B DL, SMPTE 425

Fiber Input (12G-AM-R, 12G-AM-TR)

- 1x 12G-SDI Fiber LC connector, SMPTE 297/259/292/424/2081/2082
 - Wavelength: Rx 1260 nm (min), 1620 nm (max)
 - Optical Sensitivity: -10 dBm (min 12 Gbps), -14 dBm (min 3 Gbps)
 - Overload Power: -2 dBm (min)

Fiber Input (12G-AM-R-ST)

- 1x 12G-SDI Fiber ST connector, SMPTE 297/259/292/424/2081/2082
 - Wavelength: Rx 1260 nm (min), 1620 nm (max)
 - Optical Sensitivity: -10 dBm (min 12 Gbps), -14 dBm (min 3 Gbps)
 - Overload Power: -2 dBm (min)

Video Output Digital

- 1x 12G-SDI BNC, SMPTE 259/292/424/2081/2082
 - Single Link SD/HD/2K/UltraHD/4K
 - Single Link 3G-SDI Level A or B-DL, SMPTE 425

Fiber Output (12G-AM-T, 12G-AM-TR)

- 1x 12G-SDI Fiber LC connector, SMPTE 297/259/292/424/2081/2082
 - Nominal Wavelength: Tx 1260 nm (min), 1310 nm (typ), 1360 nm (max)
 - Optical Power: -5 dBm (min), 0.5 dBm (max)
 - Extinction Ratio: 5.4 dB (min)

Fiber Output (12G-AM-T-ST)

- 1x 12G-SDI Fiber ST connector, SMPTE 297/259/292/424/2081/2082
- Nominal Wavelength: Tx 1260 nm (min), 1310 nm (typ), 1360 nm (max)
- Optical Power: -5 dBm (min), 2 dBm (max)
- Extinction Ratio: 3.4 dB (min)

Cable Equalization

(Belden 1694A coax)

- 12 Gbps, 65m
- 6 Gbps, 125m
- 3 Gbps, 190m
- 1.5 Gbps, 200m
- 270 Mbps, 405m

Video Path Delay

- Video Out is a delayed, reclocked version of Video In, at same frame rate, etc. Video Out is undefined when no input.
- Video Latency, time measured between video input and video output connector:
 - 12G = 3.2 μ sec
 - 6G = 3.2 μ sec
 - 3G level A = 3.2 μ sec
 - 3G level B-DL = 6.3 μ sec
 - HD (1.5 Gb) = 6.3 μ sec
 - SD (270 Mb) = 17.2 μ sec

Audio Inputs and Outputs

- AES PCM audio, 1x 25 pin D female connector on converter, 8-channels in, 8-channels out, selectable in pairs
- Breakout cable provided with 1x 25 pin D male connector:
 - 4x XLR female input breakout connectors (AES3 110 ohm)
 - 4x XLR male output breakout connectors (AES3 110 ohm)

Audio Data Formats

- AES3-2003

Embedded Audio

- SMPTE 272M (SD): 20-bit, 48 kHz synchronous
- SMPTE 299M (3G/HD): 24-bit, 48 kHz synchronous
- Incoming embedded audio can be passed, removed, or overridden
- Up to 16-channels supported

Note: 2048x1080p/PsF 29.97 and 30 formats support a maximum of 8-channels embedded audio.

Embed Path Audio Latency

(Time measured between audio input and video output connector):

- 1500 μ sec (SRC ON)
- 400 μ sec (SRC OFF)

Disembed Path Audio Latency

(Time measured between video input and audio output connector):

- 210 μ sec

User Interface

- External DIP switch
- USB port used with Mini-Config software application to configure the device via PC/Mac

Size (w x d x h)

- 5.8" x 3.1" x 1.0" (147.32 x 78.74 x 25.4 mm)

Weight

- 0.6 lb (0.3 kg)

Power

- +5-16VDC, 10 watts, power supply required, included with purchase

Environment

- Safe Operating Temperature: 0 to 40 C (32 to 104 F)
- Safe Storage Temperature (Power OFF): -40 to 60 C (-40 to 140 F)
- Operating Relative Humidity: 10-90% noncondensing
- Operating Altitude: <3,000 meters (<10,000 feet)

Appendix B – Safety and Compliance

Federal Communications Commission (FCC) Compliance Notices

Class A Interference Statement

This equipment has been tested and found to comply with the limits for a Class A digital device, pursuant to Part 15, Subpart B of the FCC Rules. These limits are designed to provide reasonable protection against harmful interference in a residential installation. This equipment generates, uses, and can radiate radio frequency energy and, if not installed and used in accordance with the instructions, may cause harmful interference to radio communications. However, there is no guarantee that interference will not occur in a particular installation. If this equipment does cause harmful interference to radio or television reception, which can be determined by turning the equipment off and on, the user is encouraged to try to correct the interference by one or more of the following measures:

- Reorient or relocate the receiving antenna.
- Increase the separation between the equipment and receiver.
- Connect the equipment into an outlet on a circuit different from that to which the receiver is connected.
- Consult the dealer or an experienced radio/TV technician for help.

FCC Caution

This device complies with Part 15 of the FCC Rules. Operation is subject to the following two conditions: (1) This device may not cause harmful interference, and (2) this device must accept any interference received, including interference that may cause undesired operation.

Canadian ICES Statement

Canadian Department of Communications Radio Interference Regulations

This digital apparatus does not exceed the Class A limits for radio-noise emissions from a digital apparatus as set out in the Radio Interference Regulations of the Canadian Department of Communications. This Class A digital apparatus complies with Canadian ICES-003.

Règlement sur le brouillage radioélectrique du ministère des Communications

Cet appareil numérique respecte les limites de bruits radioélectriques visant les appareils numériques de classe A prescrites dans le Règlement sur le brouillage radioélectrique du ministère des Communications du Canada. Cet appareil numérique de la Classe A est conforme à la norme NMB-003 du Canada.

European Union, European Free Trade Association (EFTA) and United Kingdom Regulatory Compliance

This equipment may be operated in the countries that comprise the member countries of the European Union, European Free Trade Association and the United Kingdom. These countries, listed in the following paragraph, are referred to as The European Community throughout this document:

AUSTRIA, BELGIUM, BULGARIA, CROATIA, CZECH REPUBLIC, DENMARK, ESTONIA, FINLAND, FRANCE, GERMANY, GREECE, HUNGARY, ICELAND, IRELAND, ITALY, LATVIA, LIECHTENSTEIN, LITHUANIA, LUXEMBOURG, MALTA, NETHERLANDS, NORWAY, POLAND, PORTUGAL, REPUBLIC OF CYPRUS, ROMANIA, SLOVAK REPUBLIC, SLOVENIA, SPAIN, SWEDEN, SWITZERLAND, UNITED KINGDOM

Declaration of Conformity

Marking by these symbols indicates compliance with the Essential Requirements of the EMC Directive of the European Union 2014/30/EU.



This equipment meets the following conformance standards:

Safety

EN 60065: 2014 (T-Mark License)

IEC 60065: 2014 (CB Scheme Report/Certificate)

EN 62368-1: 2014 + A11 (T-Mark License)

IEC 62368-1: 2014 (CB Scheme Certificate)

Additional licenses issued for specific countries available on request.

Emissions

EN 55032: 2012 + AC: 2013, CISPR 32: 2015,

EN 61000-3-2: 2014, EN 61000-3-3: 2013

Immunity

EN 55103-2: 2009

EN 61000-4-2:2009, EN 61000-4-3:2006 +A1:2008 +A2:2010,

EN 61000-4-4:2004 +A1:2010, EN 61000-4-5:2006, EN 61000-4-6: 2009

EN 61000-4-11:2004

Laser

EN 60825-1: 2007 and EN 60825-2: 2004 +A2: 2010,

CDRH Compliant Class 1 (TUV Cert No. 50135086)

Also Licensed for Standards: FDA 21 CFR 1040.10 and 1040.11

The product is also licensed for additional country specific standards as required for the International Marketplace.



Warning! This is a Class A product. In a domestic environment, this product may cause radio interference, in which case, the user may be required to take appropriate measures.

Achtung! Dieses ist ein Gerät der Funkstörgrenzwertklasse A. In Wohnbereichen können bei Betrieb dieses Gerätes Rundfunkstörungen auftreten, in welchen Fällen der Benutzer für entsprechende Gegenmaßnahmen verantwortlich ist.

Attention! Ceci est un produit de Classe A. Dans un environnement domestique, ce produit risque de créer des interférences radioélectriques, il appartiendra alors à l'utilisateur de prendre les mesures spécifiques appropriées.

Recycling Notice



This symbol on the product or its packaging indicates that this product must not be disposed of with your other household waste. Instead, it is your responsibility to dispose of your waste equipment by handing it over to a designated collection point for the recycling of waste electrical and electronic equipment. The separate collection and recycling of your waste equipment at the time of disposal will help conserve natural resources and ensure that it is recycled in a manner that protects human health and the environment. For more information about where you can drop off your waste for recycling, please contact your local authority, or where you purchased your product.

Korea KCC Compliance Statement

사 용 자 안 내 문

이 기기는 업무용 환경에서 사용할 목적으로 적합성평가를 받은 기기로서 가정용 환경에서 사용하는 경우 전파간섭의 우려가 있습니다.

Taiwan Compliance Statement

警告使用者：
這是甲類的資訊產品，在居住的環境中使用時，可能會造成射頻干擾，在這種情況下，使用者會被要求採取某些適當的對策。

This is a Class A product based on the standard of the Bureau of Standards, Metrology and Inspection (BSMI) CNS 13438, Class A. In a domestic environment this product may cause radio interference in which case the user may be required to take adequate measures.

Japan Compliance Statement

この装置は、クラスA情報技術装置です。この装置を家庭環境で使用すると電波妨害を引き起こすことがあります。この場合には使用者が適切な対策を講ずるよう要求されることがあります。 VCCI-A

This is a Class A product based on the standard of the VCCI Council (VCCI 32: 2016). If this equipment is used in a domestic environment, radio interference may occur, in which case, the user may be required to take corrective actions.

Translated Warning and Caution Messages

The following caution statements, warning conventions, and warning messages apply to this product and manual.



Warning Symbol



Caution Symbol

Before Operation Please Read These Instructions



Warning! Read and follow all warning notices and instructions marked on the product or included in the documentation.

Avertissement! Lisez et conformez-vous à tous les avis et instructions d'avertissement indiqués sur le produit ou dans la documentation.

Warnung! Lesen und befolgen Sie die Warnhinweise und Anweisungen, die auf dem Produkt angebracht oder in der Dokumentation enthalten sind.

¡Advertencia! Lea y siga todas las instrucciones y advertencias marcadas en el producto o incluidas en la documentación.

Aviso! Leia e siga todos os avisos e instruções assinalados no produto ou incluídos na documentação.

Avviso! Leggere e seguire tutti gli avvisi e le istruzioni presenti sul prodotto o inclusi nella documentazione.



Warning! Do not use this device near water and clean only with a dry cloth.

Avertissement! N'utilisez pas cet appareil près de l'eau et nettoyez-le seulement avec un tissu sec.

Warnung! Das Gerät nicht in der Nähe von Wasser verwenden und nur mit einem trockenen Tuch säubern.

¡Advertencia! No utilice este dispositivo cerca del agua y límpielo solamente con un paño seco.

Aviso! Não utilize este dispositivo perto da água e limpe-o somente com um pano seco.

Avviso! Non utilizzare questo dispositivo vicino all'acqua e pulirlo soltanto con un panno asciutto.



Warning! Do not block any ventilation openings. Install in accordance with the manufacturer's instructions.

Avertissement! Ne bloquez aucune ouverture de ventilation. Suivez les instructions du fabricant lors de l'installation.

Warnung! Die Lüftungsöffnungen dürfen nicht blockiert werden. Nur gemäß den Anweisungen des Herstellers installieren.

¡Advertencia! No bloquee ninguna de las aberturas de la ventilación. Instale de acuerdo con las instrucciones del fabricante.

Aviso! Não obstrua nenhuma das aberturas de ventilação. Instale de acordo com as instruções do fabricante.

Avviso! Non ostruire le aperture di ventilazione. Installare in conformità con le istruzioni del fornitore.



Warning! Do not install near any heat sources such as radiators, heat registers, stoves, or other apparatus (including amplifiers) that produce heat.

Avertissement! N'installez pas l'appareil près d'une source de chaleur telle que des radiateurs, des bouches d'air de chauffage, des fourneaux ou d'autres appareils (amplificateurs compris) qui produisent de la chaleur.

Warnung! Nicht in der Nähe von Wärmequellen wie Heizkörpern, Heizregistern, Öfen oder anderen Wärme erzeugenden Geräten (einschließlich Verstärkern) aufstellen.

¡Advertencia! No instale cerca de fuentes de calor tales como radiadores, registros de calor, estufas u otros aparatos (incluidos amplificadores) que generan calor.

Aviso! Não instale perto de nenhuma fonte de calor tal como radiadores, saídas de calor, fogões ou outros aparelhos (incluindo amplificadores) que produzam calor.

Avviso! Non installare vicino a fonti di calore come termosifoni, diffusori di aria calda, stufe o altri apparecchi (amplificatori compresi) che emettono calore.



Warning! Do not defeat the safety purpose of the polarized or grounding-type plug. A polarized plug has two blades with one wider than the other. A grounding type plug has two blades and a third grounding prong. The wide blade or the third prong are provided for your safety. If the provided plug does not fit into your outlet, consult an electrician for replacement of the obsolete outlet.

Avertissement! La sécurité de la prise polarisée ou de la prise de type mise à la terre ne doit en aucun cas être empêchée de fonctionner. Une prise polarisée a deux broches, l'une étant plus large que l'autre. Une prise de type mise à la terre a deux broches et une troisième broche pour la mise à la terre. La broche large ou la troisième broche sont fournies pour votre sécurité. Si la prise fournie ne s'insère pas dans votre prise femelle, consultez un électricien pour le remplacement de la prise femelle obsolète.

Warnung! Der Sicherheitszweck des gepolten bzw. Schukosteckers ist zu berücksichtigen. Ein gepolter Stecker verfügt über zwei Pole, von denen einer breiter als der andere ist. Ein Schukostecker verfügt neben den zwei Polen noch über einen dritten Pol zur Erdung. Der breite Pol bzw. der Erdungspol dienen der Sicherheit. Wenn der zur Verfügung gestellte Stecker nicht in Ihren Anschluss passt, konsultieren Sie einen Elektriker, um den veralteten Anschluss zu ersetzen.

¡Advertencia! No eche por tierra la finalidad del tipo de enchufe polarizado con conexión a tierra. Un enchufe polarizado tiene dos espigas, una más ancha que la otra. Un enchufe con conexión a tierra tiene dos espigas iguales y una tercera espiga que sirve para la conexión a tierra. La espiga ancha, o la tercera espiga, sirven para su seguridad. Si el enchufe suministrado no encaja en el tomacorriente, consulte con un electricista para reemplazar el tomacorriente obsoleto.

Aviso! Não anule a finalidade da segurança da ficha polarizada ou do tipo ligação terra. Uma ficha polarizada tem duas lâminas sendo uma mais larga do que a outra. Uma ficha do tipo de ligação à terra tem duas lâminas e um terceiro terminal de ligação à terra. A lâmina larga ou o terceiro terminal são fornecidos para sua segurança. Se a ficha fornecida não couber na sua tomada, consulte um electricista para a substituição da tomada obsoleta.

Avviso! Non compromettere la sicurezza della spina polarizzata o con messa a terra. Una spina polarizzata ha due spinotti, di cui uno più largo. Una spina con messa a terra ha due spinotti e un terzo polo per la messa a terra. Lo spinotto largo o il terzo polo sono forniti per motivi di sicurezza. Se la spina fornita non si inserisce nella presa di corrente, contattare un elettricista per la sostituzione della presa obsoleta.



Warning! Since the Mains plug is used as the disconnection for the device, it must remain readily accessible and operable.

Avertissement! Puisque la prise principale est utilisée pour débrancher l'appareil, elle doit rester aisément accessible et fonctionnelle.

Warnung! Da der Netzstecker als Trennvorrichtung dient, muss er stets zugänglich und funktionsfähig sein.

¡Advertencia! Puesto que el enchufe de la red eléctrica se utiliza como dispositivo de desconexión, debe seguir siendo fácilmente accesible y operable.

Aviso! Dado que a ficha principal é utilizada como a desconexão para o dispositivo, esta deve manter-se prontamente acessível e funcional.

Avviso! Poiché il cavo di alimentazione viene usato come dispositivo di sconnessione, deve rimanere prontamente accessibile e operabile.



Warning! Protect the power cord from being walked on or pinched particularly at plugs, convenience receptacles, and the point where they exit from the device.

Avertissement! Protégez le cordon d'alimentation pour que l'on ne marche pas dessus ou qu'on le pince, en particulier au niveau des prises mâles, des réceptacles de convenance, et à l'endroit où il sort de l'appareil.

Warnung! Vermeiden Sie, dass auf das Netzkabel getreten oder das Kabel geknickt wird, insbesondere an den Steckern, den Steckdosen und am Kabelausgang am Gerät.

¡Advertencia! Proteja el cable de corriente para que no se le pise ni apriete, en especial cerca del enchufe, los receptáculos de conveniencia y el punto del que salen del equipo.

Aviso! Proteja o cabo de alimentação de ser pisado ou de ser comprimido particularmente nas fichas, em tomadas de parede de conveniência e no ponto de onde sai do dispositivo.

Avviso! Proteggere il cavo di alimentazione in modo che nessuno ci cammini sopra e che non venga schiacciato soprattutto in corrispondenza delle spine e del punto in cui esce dal dispositivo.



Warning! Unplug this device during lightning storms or when unused for long periods of time.

Avertissement! Débranchez cet appareil pendant les orages avec éclairsou s'il est inutilisé pendant de longues périodes.

Warnung! Das Gerät ist bei Gewitterstürmen oder wenn es über lange Zeiträume ungenutzt bleibt vom Netz zu trennen.

¡Advertencia! Desenchufe este dispositivo durante tormentas eléctricas o cuando no se lo utilice por largos periodos del tiempo.

Aviso! Desconecte este dispositivo da tomada durante trovoadas ou quando não é utilizado durante longos períodos de tempo.

Avviso! Utilizzare soltanto i collegamenti e gli accessori specificati e/o venduti dal produttore, quali il treppiedi e l'esoscheletro.



Warning! Refer all servicing to qualified service personnel. Servicing is required when the device has been damaged in any way, such as power-supply cord or plug is damaged, liquid has been spilled or objects have fallen into the device, the device has been exposed to rain or moisture, does not operate normally, or has been dropped.

Avertissement! Référez-vous au personnel de service qualifié pour tout entretien. L'entretien est exigé quand l'appareil a été endommagé de quelque manière que ce soit, par exemple lorsque le cordon d'alimentation ou la prise sont endommagés, que du liquide a été versé ou des objets sont tombés dans l'appareil, que l'appareil a été exposé à la pluie ou à l'humidité, ne fonctionne pas normalement ou est tombé.

Warnung! Das Gerät sollte nur von qualifizierten Fachkräften gewartet werden. Eine Wartung ist fällig, wenn das Gerät in irgendeiner Weise beschädigt wurde, wie bei beschädigtem Netzkabel oder Netzstecker, falls Flüssigkeiten oder Objekte in das Gerät gelangen, das Gerät Regen oder Feuchtigkeit ausgesetzt wurde, nicht ordnungsgemäß funktioniert oder fallen gelassen wurde.

¡Advertencia! Consulte al personal calificado por cuestiones de reparación. El servicio de reparación se requiere cuando el dispositivo ha recibido cualquier tipo de daño, por ejemplo cable o espigas dañadas, se ha derramado líquido o se han caído objetos dentro del dispositivo, el dispositivo ha sido expuesto a la lluvia o humedad, o no funciona de modo normal, o se ha caído.

Aviso! Remeta todos os serviços de manutenção para o pessoal de assistência qualificado. A prestação de serviços de manutenção é exigida quando o dispositivo foi danificado mediante qualquer forma, como um cabo de alimentação ou ficha que se encontra danificado/a, quando foi derramado líquido ou caíram objectos sobre o dispositivo, quando o dispositivo foi exposto à chuva ou à humidade, quando não funciona normalmente ou quando foi deixado cair.

Avviso! Fare riferimento al personale qualificato per tutti gli interventi di assistenza. L'assistenza è necessaria quando il dispositivo è stato danneggiato in qualche modo, ad esempio se il cavo di alimentazione o la spina sono danneggiati, è stato rovesciato del liquido è stato rovesciato o qualche oggetto è caduto nel dispositivo, il dispositivo è stato esposto a pioggia o umidità, non funziona correttamente o è caduto.



Warning! Do not open the chassis. There are no user-serviceable parts inside. Opening the chassis will void the warranty unless performed by an AJA service center or licensed facility.

Avertissement! Ne pas ouvrir le châssis. Aucun élément à l'intérieur du châssis ne peut être réparé par l'utilisateur. La garantie sera annulée si le châssis est ouvert par toute autre personne qu'un technicien d'un centre de service ou d'un établissement agréé AJA.

Warnung! Öffnen Sie das Gehäuse nicht. Keine der Geräteteile können vom Benutzer gewartet werden. Durch das Öffnen des Gehäuses wird die Garantie hinfällig, es sei denn, solche Wartungsarbeiten werden in einem AJA-Service-Center oder einem lizenzierten Betrieb vorgenommen.

¡Advertencia! No abra el chasis. El interior no contiene piezas reparables por el usuario. El abrir el chasis anulará la garantía a menos que se lo haga en un centro de servicio AJA o en un local autorizado.

Advertência! Não abra o chassi. Não há internamente nenhuma peça que permita manutenção pelo usuário. Abrir o chassi anula a garantia, a menos que a abertura seja realizada por uma central de serviços da AJA ou por um local autorizado.

Avvertenza! Non aprire lo chassis. All'interno non ci sono parti riparabili dall'utente. L'apertura dello chassis invaliderà la garanzia se non viene effettuata da un centro ufficiale o autorizzato AJA.



Warning! Disconnect the external AC power supply line cord(s) from the mains power before moving the unit.

Avertissement! Retirez le ou les cordons d'alimentation en CA de la source d'alimentation principale lorsque vous déplacez l'appareil.

Warnung! Trennen Sie die Wechselstrom-Versorgungskabel vom Netzstrom, bevor Sie das Gerät verschieben.

¡Advertencia! Cuando mueva la unidad desenchufe de la red eléctrica el/los cable(s) de la fuente de alimentación CA tipo brick.

Advertência! Remova os cabos CA de alimentação brick da rede elétrica ao mover a unidade.

Avvertenza! Scollegare il cavo dell'alimentatore quando si sposta l'unità.



Warning! Only use attachments and accessories specified and/or sold by the manufacturer.

Avertissement! Utilisez seulement les attaches et accessoires spécifiés et/ou vendus par le fabricant.

Warnung! Verwenden Sie nur Zusatzgeräte und Zubehör angegeben und / oder verkauft wurde durch den Hersteller.

¡Advertencia! Utilice solamente los accesorios y conexiones especificados y/o vendidos por el fabricante.

Aviso! Utilize apenas equipamentos/acessórios especificados e/ou vendidos pelo fabricante.

Avviso! Utilizzare soltanto i collegamenti e gli accessori specificati e/o venduti dal produttore.



Caution! 12G-AM devices require the use of "single mode 1310nm compatible" fiber optic cable.

Aviso! Dispositivos 12G-AM exigem a utilização de cabo de fibra ótica "compatível com monomodo 1310nm".

Attention! Les équipements 12G-AM doivent être utilisés avec un câble en fibre optique monomode compatible 1310 nm.

Attenzione! I dispositivi 12G-AM richiedono l'uso di un cavo a fibre ottiche "compatibile con 1310 nm monomodo".

¡Precaución! 12G-AM dispositivos requieren el uso de cable de fibra óptica "monomodo 1310nm compatibles".

Vorsicht! 12G-AM-Geräte erfordern den Gebrauch von "Einzelmodus 1310nm kompatiblen" Faseroptik-Kabeln.



Warning! Active fiber-optic cables emit radiation invisible to the human eye. Do not look directly at the end of an active fiber-optic cable; the 12G-AM is a Class 1 Laser Product.



CLASS 1
LASER
PRODUCT

Advertência! Cabos de fibra ótica ativos emitem radiação invisível ao olho humano. Não olhe diretamente para a extremidade de um cabo de fibra ótica ativo; o 12G-AM é um produto laser de classe 1.



PRODUTO
LASER DE
CLASSE 1

Avertissement! Lorsqu'ils sont actifs, les câbles en fibre optique émettent des radiations que l'oeil humain ne peut voir. Ne regardez pas directement l'extrémité d'un câble en fibre optique en cours d'utilisation ; les équipements 12G-AM sont des produits laser de classe 1.



PRODUITS
LASER DE
CLASSE 1

Avvertenza! I cavi a fibre ottiche attivi (ossia in cui si propagano segnali) emettono radiazioni invisibili. Non fissare lo sguardo direttamente sull'estremità di un cavo a fibre ottiche attivo; il cavo 12G-AM è un prodotto laser di Classe 1.



PRODOTTO
LASER DI
CLASSE 1

¡Advertencia! Active los cables de fibra óptica de emitir radiación invisible para el ojo humano. No mire directamente en el extremo de un cable de fibra óptica activa; el 12G-AM es un producto láser de Clase 1.



CLASE 1
LASER
PRODUCTO

Achtung! Aktive Faseroptik-Kabel geben eine Strahlung ab, die für das menschliche Auge unsichtbar ist. Das Ende eines aktiven Faseroptik-Kabels niemals direkt ansehen; die 12G-AM ist ein Laser-Produkt der Klasse 1.



KLASSE 1
LASER-
PRODUKT

5-Year Warranty and Liability Information

Limited Warranty on Hardware

AJA Video Systems, Inc. (AJA Video) warrants that the hardware product, not including software components, will be free from defects in materials and workmanship for a period of five years from the date of purchase. AJA Video provides a separate software warranty as part of the license agreement applicable to software components.

If the Customer brings a valid claim under this limited warranty for a hardware product (hereafter, a “product”) during the applicable warranty period, AJA Video will, at its sole option and as the Customer’s sole remedy for breach of the above warranty, provide one of the following remedies:

- Repair or facilitate the repair the product within a reasonable period of time, free of charge for parts and labor.
- Replace the product with a direct replacement or with a product that performs substantially the same function as the original product.
- Issue a refund of the original purchase price less depreciation to be determined based on the age of the product at the time remedy is sought under this limited warranty.

To obtain service under this warranty, the Customer must notify AJA Video of the defect before expiration of the warranty period and make suitable arrangements for the performance of service by contacting AJA Video support through the channels set forth on the support contacts web page at <https://www.aja.com/support>.

Except as stated, the Customer shall bear all shipping, packing, insurance and other costs, excluding parts and labor, to effectuate repair. Customer shall pack and ship the defective product to a service center designated by AJA Video, with shipping charges prepaid. AJA Video shall pay to return the product to Customer, but only if to a location within the country in which the AJA Video service center is located. SOME JURISDICTIONS DO NOT ALLOW THE EXCLUSION OF IMPLIED WARRANTIES OR LIMITATIONS ON APPLICABLE STATUTORY RIGHTS OF A CONSUMER, SO SOME OR ALL OF THE TERMS OF THIS PARAGRAPH MAY NOT APPLY TO YOU.

Limitation of Liability

Under no circumstances shall AJA video BE LIABLE IN ANY WAY FOR ANY LOST, CORRUPTED OR DESTROYED DATA, FOOTAGE OR WORK, OR FOR ANY OTHER INDIRECT, SPECIAL, INCIDENTAL OR CONSEQUENTIAL DAMAGES OR LOST PROFITS, OR FOR ANY THIRD PARTY CLAIM, IN CONNECTION WITH THE PRODUCT, WHETHER RESULTING FROM DEFECTS IN THE PRODUCT, SOFTWARE OR HARDWARE FAILURE, OR ANY OTHER CAUSE WHATSOEVER, EVEN IF AJA VIDEO HAS BEEN ADVISED OF THE POSSIBILITY OF SUCH DAMAGES. AJA VIDEO’S LIABILITY IN CONNECTION WITH THE PRODUCT SHALL UNDER NO CIRCUMSTANCES EXCEED THE PURCHASE PRICE PAID FOR THE PRODUCT. The foregoing limitations apply even if any remedy set forth in this LIMITED WARRANTY fails of its essential purpose. SOME JURISDICTIONS DO NOT ALLOW THE LIMITATION OF LIABILITY FOR PERSONAL INJURY, OR OF INCIDENTAL OR CONSEQUENTIAL DAMAGES, SO SOME OR ALL OF THE TERMS OF THIS PARAGRAPH MAY NOT APPLY TO YOU.

Governing Law and Language; Your Rights

This limited warranty is the only warranty provided by AJA Video on the hardware product. It supersedes all prior or contemporaneous understandings regarding such subject matter. No amendment to or modification of this warranty will be binding unless in writing and signed by AJA Video. The laws of the State of California, USA will govern this warranty and any dispute arising from it. Any translation of this Agreement is intended for convenience and to meet local requirements and in the event of a dispute between the English and any non-English versions, the English version of this warranty will govern. This limited warranty gives you specific legal rights and you may have other rights that vary from jurisdiction to jurisdiction, some of which are noted above.

AJA Software License Agreement

AJA VIDEO SYSTEMS, INC.

THIS IS AN AGREEMENT BETWEEN YOU AND AJA VIDEO SYSTEMS, INC. (“AJA”) THAT GOVERNS YOUR USE OF THE SOFTWARE ACCOMPANYING THIS LICENSE (E.G., AS INSTALLED ON THE DEVICE WITH WHICH THIS LICENSE IS PROVIDED).

The “AJA Software” referenced in this Agreement includes all such software, whether made available to you on disk, in read only memory, on any other media or in any other form, and all updates, corrections, enhancements and new versions of such software made available by AJA, together with all related documentation. BY INSTALLING OR USING THE AJA SOFTWARE, YOU ARE AGREEING TO BE BOUND BY THE TERMS OF THIS AGREEMENT. IF YOU DO NOT AGREE TO THE TERMS OF THIS AGREEMENT, DO NOT INSTALL OR USE IT AND, IF APPLICABLE, RETURN THE AJA SOFTWARE TO THE PLACE WHERE YOU OBTAINED IT FOR A REFUND.

1. License Grant. AJA hereby grants you a nonexclusive, personal, non-sublicenseable and limited license to install and use AJA Software on a computer or AJA device. The foregoing license also includes the right to make copies of the AJA Software in machine-readable form for installation and backup purposes only, and provided that each copy you make must include all copyright or other proprietary notices contained on the original.

2. Limitations. You may not decompile, reverse engineer, disassemble, modify, or create derivative works of the AJA Software or any part thereof except to the extent (if any) authorized by applicable law notwithstanding the foregoing restriction. You may not rent, lease, lend, loan, distribute or act as a service bureau or “cloud service” provider with respect to use of the AJA Software or any functionality thereof. THE AJA SOFTWARE IS NOT INTENDED FOR USE IN THE OPERATION OF NUCLEAR FACILITIES, AIRCRAFT NAVIGATION OR COMMUNICATION SYSTEMS, AIR TRAFFIC CONTROL SYSTEMS, LIFE SUPPORT MACHINES OR OTHER EQUIPMENT IN WHICH THE FAILURE OF THE AJA SOFTWARE COULD LEAD TO DEATH, PERSONAL INJURY, OR SEVERE PHYSICAL OR ENVIRONMENTAL DAMAGE.

3. Reservation of Rights. The AJA Software is protected by law, including without limitation copyright law. The AJA Software is licensed, not sold, to you. AJA and its licensors reserve all rights not expressly granted to you by this Agreement. You own the media on which the AJA Software is recorded but AJA and/or AJA's licensor(s) retain ownership of the AJA Software itself. You may not use the AJA Software for any illegal purpose.

4. Transfer. You may make a one-time permanent transfer of all of your license rights to the AJA Software to another person or entity, provided that: (a) you transfer all of the AJA Software, including all its component parts, original media, printed materials and this Agreement; (b) you do not retain any copies of the AJA Software, including any copies stored on a computer or other device; and (c) you transfer the AJA Software subject to this Agreement, and the person or entity receiving the AJA Software accepts the terms and conditions of this Agreement.

5. NFR (Not for Resale) Copies and Add-On Features: Notwithstanding anything to the contrary in this Agreement, (a) AJA Software that is labeled “Not for Resale” or otherwise provided to you on a promotional or demonstration basis may be used only for your demonstration, testing and evaluation purposes and may not be resold or transferred; and (b) AJA may make available certain software components (“Add-On Features”) under separate terms and conditions, in which case those separate terms and conditions apply and the Add-On Features are not considered AJA Software under this Agreement.

6. Termination. Your rights in the AJA Software are conditioned on complying with this Agreement, and those rights (together with this Agreement) will terminate automatically, without notice from AJA, if you fail to comply with any term(s) of this Agreement. Upon termination of this Agreement, you must cease all use of the AJA Software and destroy all copies, full or partial, of the AJA Software in your possession or control.

7. Limited Warranty on AJA Software. If you comply with all terms of this Agreement and use the AJA Software in accordance with its documentation, and you install any patches or other updates made available to the AJA Software by AJA, AJA warrants that the AJA Software will perform substantially in accordance with its documentation for a period of ninety (90) days from the date of your original retail purchase. Your exclusive remedy under this warranty will be, at AJA's option, a refund of the purchase

price of the product containing the AJA Software or an update to or replacement of the AJA Software (or applicable component of it). THIS LIMITED WARRANTY AND ANY IMPLIED WARRANTIES ON THE AJA SOFTWARE INCLUDING, BUT NOT LIMITED TO, ANY WARRANTIES OF MERCHANTABILITY, OF SATISFACTORY QUALITY, OR OF FITNESS FOR A PARTICULAR PURPOSE, ARE LIMITED IN DURATION TO NINETY (90) DAYS FROM THE DATE OF ORIGINAL RETAIL PURCHASE. SOME JURISDICTIONS DO NOT ALLOW LIMITATIONS ON HOW LONG A WARRANTY LASTS, SO THE ABOVE LIMITATION MAY NOT APPLY TO YOU. THIS LIMITED WARRANTY GIVES YOU SPECIFIC LEGAL RIGHTS, AND YOU MAY ALSO HAVE OTHER RIGHTS WHICH VARY BY JURISDICTION.

8. Disclaimer of Other Warranties on AJA Software. EXCEPT FOR THE LIMITED WARRANTY ON AJA SOFTWARE SET FORTH ABOVE, AJA AND AJA'S LICENSORS (COLLECTIVELY REFERRED TO AS "AJA" FOR THE PURPOSES OF SECTIONS 8 AND 9) HEREBY DISCLAIM ALL WARRANTIES AND CONDITIONS WITH RESPECT TO THE AJA SOFTWARE, WHETHER EXPRESS, IMPLIED OR STATUTORY, INCLUDING, BUT NOT LIMITED TO, THE IMPLIED WARRANTIES AND/OR CONDITIONS OF MERCHANTABILITY, OF SATISFACTORY QUALITY, OF FITNESS FOR A PARTICULAR PURPOSE, OF ACCURACY, AND OF QUIET ENJOYMENT. FURTHER, AJA DOES NOT MAKE ANY WARRANTY REGARDING NON-INFRINGEMENT OF THIRD PARTY RIGHTS. SUBJECT ONLY TO THE LIMITED WARRANTY SET FORTH IN SECTION 7, YOU EXPRESSLY ACKNOWLEDGE AND AGREE THAT USE OF THE AJA SOFTWARE IS AT YOUR SOLE RISK. AJA DOES NOT WARRANT AGAINST INTERFERENCE WITH YOUR ENJOYMENT OF THE AJA SOFTWARE, THAT THE AJA SOFTWARE WILL MEET YOUR REQUIREMENTS, THAT THE OPERATION OF THE AJA SOFTWARE WILL BE UNINTERRUPTED OR ERROR-FREE, OR THAT DEFECTS IN THE AJA SOFTWARE WILL BE CORRECTED. NO ORAL OR WRITTEN INFORMATION OR ADVICE GIVEN BY AJA OR AN AJA AUTHORIZED REPRESENTATIVE WILL CREATE A WARRANTY. SOME JURISDICTIONS DO NOT ALLOW THE EXCLUSION OF IMPLIED WARRANTIES OR LIMITATIONS ON APPLICABLE STATUTORY RIGHTS OF A CONSUMER, SO SOME OR ALL OF THE TERMS OF THIS PARAGRAPH MAY NOT APPLY TO YOU.

9. Limitation of Liability. TO THE EXTENT NOT PROHIBITED BY LAW, IN NO EVENT WILL AJA BE LIABLE FOR PERSONAL INJURY, OR ANY INCIDENTAL, SPECIAL, INDIRECT OR CONSEQUENTIAL DAMAGES OR LOST PROFITS WHATSOEVER, INCLUDING, WITHOUT LIMITATION, DAMAGES FOR LOSS OF DATA, BUSINESS INTERRUPTION OR ANY OTHER COMMERCIAL DAMAGES OR LOSSES, ARISING OUT OF OR RELATED TO YOUR USE OR INABILITY TO USE THE AJA SOFTWARE, HOWEVER CAUSED, REGARDLESS OF THE THEORY OF LIABILITY (E.G., WHETHER UNDER CONTRACT, TORT OR OTHERWISE) AND EVEN IF AJA HAS BEEN ADVISED OF THE POSSIBILITY OF SUCH DAMAGES. IN NO EVENT WILL AJA'S TOTAL LIABILITY TO YOU FOR ALL DAMAGES (INCLUDING WITHOUT LIMITATION BREACH OF WARRANTY) EXCEED THE AMOUNT OF FIFTY DOLLARS (\$50.00). THE FOREGOING LIMITATIONS WILL APPLY EVEN IF THE ANY REMEDY SET FORTH IN THIS AGREEMENT FAILS OF ITS ESSENTIAL PURPOSE. SOME JURISDICTIONS DO NOT ALLOW THE LIMITATION OF LIABILITY FOR PERSONAL INJURY, OR OF INCIDENTAL OR CONSEQUENTIAL DAMAGES, SO SOME OR ALL OF THE TERMS OF THIS PARAGRAPH MAY NOT APPLY TO YOU.

10. Export Law Assurances. You may not use or otherwise export or reexport the AJA Software except as authorized by United States law and the laws of the jurisdiction in which the AJA Software was obtained. In particular, but without limitation, the AJA Software may not be exported or re-exported (a) into (or to a national or resident of) any U.S. embargoed countries, or (b) to anyone on the U.S. Treasury Department's list of Specially Designated Nationals or the U.S. Department of Commerce Denied Persons List or Entity List or any similar legal designation. By using the AJA Software, you represent and warrant that you are not located in, under control of, or a national or resident of any such country or on any such list.

11. Government End Users. The AJA Software including its documentation is a "Commercial Item", as that term is defined at 48 C.F.R. § 2.101, consisting of "Commercial Computer Software" and "Commercial Computer Software Documentation", as such terms are used in 48 C.F.R. § 12.212 or 48 C.F.R. § 227.7202 (or their successors), as applicable. Consistent with these provisions, the AJA Software is licensed to U.S. Government end users (a) only as a Commercial Item and (b) with only those rights as are granted to all other end users pursuant to this Agreement. Unpublished-rights reserved under the copyright laws of the United States.

12. Controlling Law and Severability. This Agreement will be governed by and construed in accordance with the laws of the State of California, as applied to agreements entered into and to be performed entirely within California between California residents. This Agreement will not be governed by the United Nations

Convention on Contracts for the International Sale of Goods, the application of which is expressly excluded. If for any reason a court of competent jurisdiction finds any provision, or portion thereof, to be unenforceable, the remainder of this Agreement will continue in full force and effect.

13. Complete Agreement; Governing Language. This Agreement constitutes the entire agreement between the parties with respect to the use of the AJA Software licensed hereunder and supersedes all prior or contemporaneous understandings regarding such subject matter. No amendment to or modification of this Agreement will be binding unless in writing and signed by AJA. Any translation of this Agreement is intended for convenience and to meet local requirements and in the event of a dispute between the English and any non-English versions, the English version of this Agreement will govern.

Index

Symbols

- 3G-SDI Level B 17
- 12G-AM I/O Connections 6
- 12G-AM Simplified Block Diagram 5

A

- AES Audio Inputs 19
- AES Audio Outputs 19
- AJA Support 2
- Audio-1 Tab Screen 18
- Audio-2 Tab Screen 20

B

- Base Model 4
- BNC DB25 Breakout Cable 9
- Breakout Cable Pinouts 8

D

- Default Operational Settings 10
- DIP Switches 6
- DIP Switch Settings 10
- Documentation
 - Downloading 13
 - Mini-Converter 12

F

- Features 5
- Fiber Options 4

H

- HANC Data: 20

I

- Input Tab Screen 17
- Installation 7

M

- Mini-Config
 - Installation on Mac 14
 - Installation on PC 13
 - Operation 15
 - Screen Description 16
 - Startup on Mac 15
 - Startup on PC 15
- Mini-Config Screen
 - Update Tab Screen 21
- Mini-Converter Documentation 12

O

- Overview 4

P

- Packet Processing Control 20

S

- Saving Setups 15
- SRC 20
- SRC Settings
 - Description 21

U

- Update Tab Screen 21

X

- XLR DB25 Breakout Cable 8