

# KONA LH Series

Capture, Display, Convert



## Installation and Operation Manual

Version 18.0  
Published March 23, 2026



# Notices

---

## Trademarks

---

AJA® and Because it matters.® are registered trademarks of AJA Video Systems, Inc. for use with most AJA products. AJA™ is a trademark of AJA Video Systems, Inc. for use with recorder, router, software and camera products. Because it matters.™ is a trademark of AJA Video Systems, Inc. for use with camera products.

Corvid Ultra®, Io®, Ki Pro®, KONA®, KUMO®, ROI® and T-Tap® are registered trademarks of AJA Video Systems, Inc.

AJA Control Room™, KiStor™, Science of the Beautiful™, TruScale™, V2Analog™ and V2Digital™ are trademarks of AJA Video Systems, Inc.

All other trademarks are the property of their respective owners.

## Copyright

---

Copyright © 2026 AJA Video Systems, Inc. All rights reserved. All information in this manual is subject to change without notice. No part of the document may be reproduced or transmitted in any form, or by any means, electronic or mechanical, including photocopying or recording, without the express written permission of AJA Video Systems, Inc.

## Contacting AJA Technical Support or Sales

---

Please have all pertinent information at hand prior to contacting AJA support or sales.

Support Telephone: +1-530-271-3190

Support Website: <https://www.aja.com/support/contact>

Support Email: [support@aja.com](mailto:support@aja.com)

Sales Email: [sales@aja.com](mailto:sales@aja.com)

Shipping Address: AJA Video Systems  
180 Litton Drive  
Grass Valley, CA 95945, USA

# Contents

---

Notices . . . . .	2
Trademarks . . . . .	2
Copyright . . . . .	2
Contacting AJA Technical Support or Sales . . . . .	2
<b>Chapter 1 – Introduction . . . . .</b>	<b>5</b>
Overview . . . . .	5
KONA Models Covered in this Manual . . . . .	5
AJA Software & Utilities . . . . .	5
System Requirements . . . . .	6
Disk Storage Methods . . . . .	7
KONA LHi* Features . . . . .	7
KONA LHe Plus Features . . . . .	8
Cable Connections . . . . .	9
KONA LHi* and LHe Plus Connectors . . . . .	9
Using Breakout Boxes . . . . .	10
KLHi-Box for KONA LHi* . . . . .	10
KL-Box for KONA LHe Plus . . . . .	11
Detailed Connector Descriptions . . . . .	11
LHe Plus/LHi* Connectors . . . . .	11
LHi Only Connectors . . . . .	12
<b>Chapter 2 – Installation . . . . .</b>	<b>13</b>
Installation Overview . . . . .	13
Unpacking . . . . .	13
Shipping Box Contents . . . . .	13
Installing the KONA Card . . . . .	13
Cabling the System . . . . .	14
KONA LHi Cable Connections . . . . .	14
KONA LHe Plus Cable Connections . . . . .	16
Installing KONA LH Series Software . . . . .	17
Download . . . . .	17
Software Package Installation and Re-installation . . . . .	17
Firmware Update Procedure . . . . .	17
<b>Chapter 3 – Operation . . . . .</b>	<b>19</b>
Using KONA with Professional Video /Audio Software . . . . .	19
Capture Formats . . . . .	19
AJA Control Panel Overview . . . . .	19
AJA Control Panel Operating Modes . . . . .	19
AJA Control Panel User Interface . . . . .	20
Controlling Application . . . . .	22
Presets . . . . .	23
Default Preferences . . . . .	24
Function Screens . . . . .	25
Control Panel Operation . . . . .	26
Control Screen . . . . .	26
Format Screen . . . . .	28
Conversion Screen . . . . .	29
Input Select Screen . . . . .	30
SDI Output Screen . . . . .	32
HDMI Screen (LHi* Only) . . . . .	33
Analog Out Screen . . . . .	35
Video Setup Screen . . . . .	36
Audio Setup Screen . . . . .	37
DS Keyer Screen . . . . .	38
LUT Screen . . . . .	40
Timecode Screen . . . . .	42

Presets Screen . . . . .	43
Firmware Screen . . . . .	44
Info Screen . . . . .	45
Using Multiple AJA Products . . . . .	45
Notes on Using Multiple AJA Products: . . . . .	46
Additional Information . . . . .	46
About 8-bit Versus 10-bit Video . . . . .	46
About 12-bit Video . . . . .	47
About RGB and YCbCr (YUV) Video . . . . .	47
Appendix A – Specifications . . . . .	48
KONA LHi* Tech Specs . . . . .	48
KONA LHe Plus Tech Specs . . . . .	51
Appendix B – Safety & Compliance . . . . .	54
3 Year Warranty and Liability Information . . . . .	61
AJA Software License Agreement . . . . .	62
Index . . . . .	65

# Chapter 1 – Introduction

---



## Overview

---

The AJA KONA LH Series brings the highest quality 2K, HD, and SD video and audio to computers running Mac, Windows or Linux Operating Systems.

### KONA Models Covered in this Manual

---

This manual covers the installation and operation of these models:

- KONA LHi\*
- KONA LHe Plus

### AJA Software & Utilities

---

AJA's KONA software and hardware were developed for powerful integrated video/audio capture, editing, and production with a variety of third party software. With KONA and a qualified computer, you have the ultimate system for production, post-production, broadcast, and streaming work. AJA software is distributed as a unified package which includes all the software, firmware, plugins, and utility programs for AJA's Io, KONA, and T-TAP products.

Four retail packages are available, one for Mac, one for Windows, and two for Linux (one package for Ubuntu, one package for Red Hat/CentOS).

*NOTE: Support for the Linux OS retail drivers is based on the Linux application used and comes from the application's vendor.*

To download AJA software, go to the AJA website:

<https://www.aja.com/support/>

For a complete software compatibility list, see the AJA website link:

<https://www.aja.com/compatibility/kona>

### LHi\* (End of Sales)

---

*IMPORTANT: As of 2025 the KONA LHi\* is "end of sales" but will continue to be supported for the foreseeable future. Refer to AJA Desktop Software release notes for limitations in functionality that may be present in successive versions of the software. Throughout this manual, we denote LHi as LHi\* for this reason.*

## Mac, Windows and Linux Packages

---

These packages include:

### Drivers

---

AJA device drivers for tightly integrated hardware/software operation.

### AJA Control Panel

---

The Control Panel provides:

- Source selection and control of your AJA hardware.
- A block diagram to show visually what routing and processing is being performed.

### AJA Control Room

---

Control Room is a cross-platform software application for ingest, playback and output with AJA devices.

### AJA System Test

---

System Test provides accurate and detailed evaluations of drive and system performance statistics, allowing you to measure the capabilities of your system for recording and playing back various resolutions and codecs. The application includes:

- System Disk Test
- AJA Device Test
- System Report

The application tests Read and Write, Capture and Playback speeds in both Megabytes per second and Frames per second. The disk speed tests differ from standard disk I/O performance applications in that they specifically test the system under conditions typically encountered with video capture, playback, and editing.

*NOTE: One way to test storage performance is to fill the target disk to 80% and then test capture at the highest data rate you will use. This may not be practical in all use cases.*

## Additional with Mac and Windows Packages

---

### Third party Plugins

---

AJA provided plugins for popular third party Professional Video Applications from Adobe, Avid, Apple, Telestream, and others.

## System Requirements

---

*NOTE: On macOS, the KONA LH Series supports Apple silicon processors as well as earlier Intel processors.*

AJA Video recommends that your system meet minimum hardware and software requirements to achieve a satisfactory level of performance. Updates to system requirements are subject to change.

See the Release Notes for your AJA Card or Device, available on the AJA website and also installed with the software package, for minimum and recommended system requirements including OS, CPU, RAM, and GPU.

*NOTE: Also see Software Vendor system requirements for GPU recommendations and additional hardware requirements and recommendations.*

*NOTE: For large scale installations with shared storage, IP, or for very high performance requirements, AJA recommends consultation with an experienced system integrator. A consultant will be able to assist with many important variables.*

## Disk Storage Methods

---

To ensure performance and quality, the disk storage system used with the workstation must be able to meet the demands of storing real-time uncompressed media. At the very minimum, the disk storage system must be able to provide and maintain a consistent transfer rate from the workstation to disk (read/write). There are a variety of system configurations and peripherals that can provide this level of performance.

For more on disk storage performance see ["AJA System Test" on page 6](#).

## KONA LHi\* Features

---

The KONA LHi\* card offers a large number of unique features for optimum quality, ease of use, and support for a wide variety of workflows and environments. KONA LHi\* provides flexible standard definition and high definition capture and playback, a hardware-based converter for working in mixed SD/HD environments—and it supports both analog and digital audio/video I/O—including HDMI.

### Video I/O

---

- 10-bit uncompressed QuickTime capture card
- 3G/HD/SD SDI I/O
- HDMI v1.3a w/Deep Color at 30 bits per pixel input/output
- 12-bit SD and HD Analog Component/Composite/S-Video I/O

### Conversion

---

- Broadcast quality hardware based 10-bit down-conversion
- Broadcast quality hardware based 10-bit up-conversion
- Broadcast quality hardware based 10-bit cross-conversion (1080 to 720 and 720 to 1080)
- Broadcast quality hardware based 10-bit SD aspect ratio conversion (anamorphic to letterbox, etc.)

### Audio I/O

---

- 2-channel analog balanced XLR audio I/O
- 2-channel AES XLR audio I/O
- 8-channel SDI embedded audio I/O

### Signal Timing

---

- HD/SD genlock on analog video inputs
- LTC Input (on Reference input)

### Cabling

---

- Cables standard
- Optional KLHi-Box Breakout Box—provides rack mounting and flexible easy I/O (KLHi-Box cabling is included with the KLHi-Box).

## KONA LHi\* Audio

---

KONA LHi\* supports 2-channel 24-bit 48kHz or 96kHz AES audio via XLR connections, and 8 channel embedded 24 bit 48kHz audio over HDMI or the same single SDI connection as the video. If you are using a digital deck, you'll have the proper connections to the deck.

For analog audio, KONA LHi\* provides two-channel balanced audio input and output. If you purchase the optional KLHi-Box breakout box, you also get two-channel unbalanced audio output (RCA jacks).

KONA LHi\* also features AES input sample rate conversion; this feature eliminates the requirement for audio source synchronization. Sample rate converters auto-lock to any AES or HDMI input, 32-96KHz, and then convert it to 24 bit 48KHz audio, perfectly locked to internal KONA LHi\* video. Sample rate conversion is done at very high quality (over 120db THD). (HDMI audio can be 20 to 24 bit and will be saved as 24 bit samples.)

## KONA LHe Plus Features

---

The KONA LHe Plus card offers a large number of unique features for optimum quality, ease of use, and support for a wide variety of workflows and environments. KONA LHe Plus provides flexible standard definition and high definition capture and playback, a hardware down-converter for working in mixed SD/HD environments—and it supports both analog and digital audio/video I/O.

### Video I/O

---

- 10-bit uncompressed SD/HD QuickTime capture card
- 12-bit HD Analog Component I/O
- 12-bit SD Analog Component/Composite/S-Video I/O
- One SDI or HD-SDI Input
- Two independent SDI/HD-SDI outputs

### Conversion

---

- Broadcast quality hardware-based 10-bit down-conversion

### Audio I/O

---

- 2-channel analog balanced XLR audio I/O
- 2-channel AES XLR audio I/O
- 8-channel SDI embedded audio I/O

### Signal Timing

---

- HD/SD genlock on analog video inputs

### Cabling

---

- Cables standard
- Optional KL-Box Breakout Box—provides rack mounting and flexible easy I/O (KL-Box cabling is included with the KL-Box). When ordering, specify a KL-Box for the KONA LHe Plus since it uses a unique cable.

## KONA LHe Plus Audio

---

KONA LHe Plus supports two-channel 24-bit 48kHz AES audio via XLR connections, and eight-channel embedded 24-bit 48kHz audio over the same single SDI connection as the video. If you are using a digital deck—you'll have the proper connections to the deck.

For analog audio, KONA LHe Plus provides two-channel balanced audio input and output. If you purchase the optional KL-Box breakout box, you also get two-channel unbalanced audio output (RCA jacks).

KONA LHe Plus also features AES input sample rate conversion; this feature eliminates the requirement for audio source synchronization. Sample rate converters auto-lock to any AES input, 32-96KHz, and then convert it to 24 bit 48KHz audio, perfectly locked to internal KONA LHe Plus video. Sample rate conversion is done at very high quality (over 120db THD).

## Cable Connections

---

KONA offers unsurpassed cable connectivity for a video/audio capture card. Connections are made via the breakout cable (included with the card) and connectors mounted on the KONA Card endplate.

### KONA LHi\* and LHe Plus Connectors

---

The breakout cable used for both KONA LHi\* and LHe Plus models provides:

- Reference Input (BNC connector)
- Component/Composite/S Video Input (3x BNC)
- Component/Composite/S Video Output (3x BNC)
- AES In (2x XLR)
- AES Out (2x XLR)
- Balanced Audio In (2x XLR)
- Balanced Audio Out (2x XLR)
- RS-422 Machine Control (9-pin)

Figure 1. Breakout Cable for LHe Plus and LHi\* Models

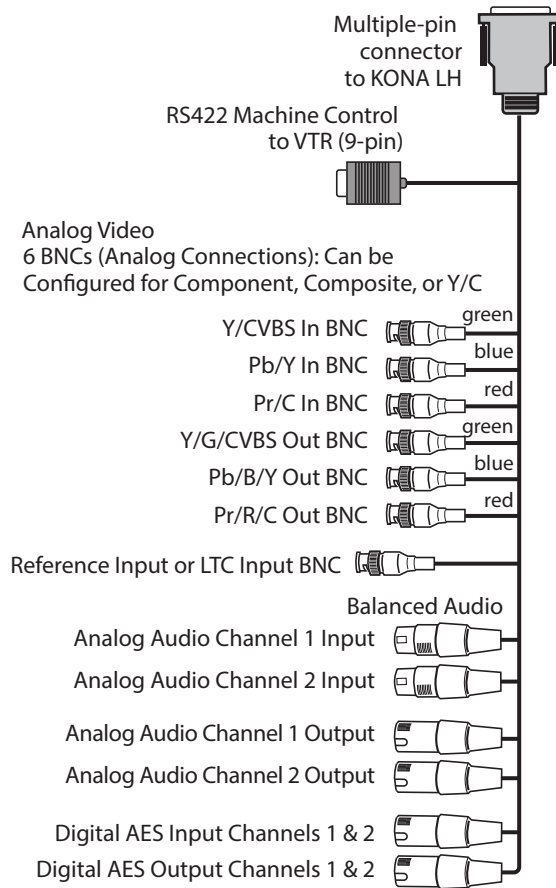

#### KONA LHi\* Endplate

Connectors on the KONA LHi\* card endplate additionally provide:

- Standard-definition or High-definition SDI input (1 BNC) and output (1 BNC)
- HDMI input and output (2x HDMI mini-connectors)

#### KONA LHe Plus Endplate

The KONA LHe Plus endplate provides one BNC for SDI input and two independent SDI output BNCs.

## Using Breakout Boxes

The KONA product line offers two optional 19" 1RU rack-mountable breakout boxes that attach to the KONA card via cables that connect to the back of the breakout box. These cables are supplied with the breakout box. The breakout boxes offer the same inputs and outputs as the standard breakout cables and more. Breakout boxes can be easily rack mounted or placed on top of a broadcast monitor or editing desk.

### KLHi-Box for KONA LHi\*

The KLHi-Box offers the same connections as the KL-Box except a single connector is provided for the following: SDI input, SDI output, HDMI v1.3a input, and HDMI v1.3a output.

*NOTE: The HDMI connectors on the breakout box are full-size, not mini as on the LHi\* endplate*

*Figure 2. KLHi-Box Model Breakout Box*

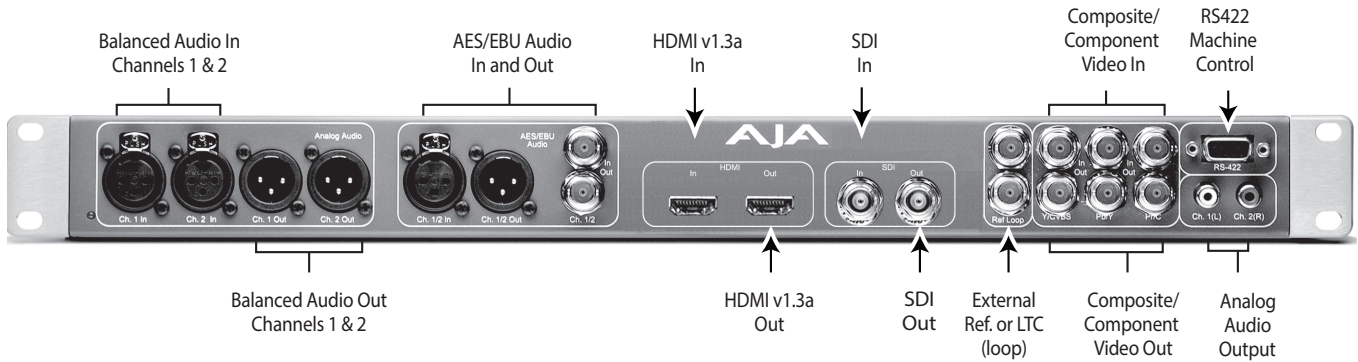

## KL-Box for KONA LHe Plus

The KL-Box is connected via one 60-pin to 60-pin, and one 3-BNC to 3-BNC cable. When you purchase the KL-Box, you get two-channel unbalanced audio output (2 RCA Jacks) not available with the standard cable. When ordering a KL-Box, specify the KONA card model you'll be using the KL box with to ensure you get the proper cable set.

*Figure 3. KL-Box Model Breakout Box*



## Detailed Connector Descriptions

### LHe Plus/LHi\* Connectors

Connectors on the standard cable set are labeled by their function for easy installation and maintenance. Connectors on the optional KL-Box are similarly labeled

#### SDI Input and Outputs

BNC connectors are provided on the KONA LHe and LHi card endplates for one SD-SDI or HD-SDI input. The LHe Plus has two, and LHi has one SDI output (format independent of the input). The SDI input and outputs support video and embedded 24-bit digital audio. Use SDI wherever possible for the best quality 10-

bit uncompressed video input, capture and output. If peripheral equipment has a variety of inputs/outputs, look to see if it has SDI I/O, and use it where possible. Most high-end professional broadcast equipment supports SDI (VTRs, cameras, media storage servers, etc.).

---

### 2-Channel Digital AES/EBU Audio Inputs And Outputs

---

One female XLR connector is provided for the channel 1 and 2 inputs, while a male XLR connector carries channel 1 and 2 outputs. AES/EBU signals are handled internally as 24-bit digital. The optional KL-Box also provides XLR audio connections on the front panel.

*NOTE: AES XLR connections are digital and cannot be used with analog equipment having XLR connectors.*

---

### Analog 2-Channel Balanced Audio

---

Two sets of analog XLR connectors, one for each channel, support balanced audio connections. Male XLRs are provided for outputs and female XLRs are provided for inputs. Balanced audio (differential) connections provide better analog audio quality over longer cable runs. Most professional quality VTRs and audio equipment have XLR style connectors for analog audio. Analog audio signals are converted internally to 24-bit digital.

---

### Unbalanced Audio on KL-Box

---

On the KL-Box are two analog output connectors, one for each channel. These connectors are RCA-style phono jacks.

---

### RS-422 Machine Control

---

A female DE-9 connector on the LHi/LHe Plus breakout cable provides connection for VTRs, camcorders, disk media servers, and other devices using RS-422 SMPTE (Sony) protocol. This RS-422 connector is also present on the optional KL-Box (connector pinout is Sony 9-pin protocol).

---

## LHi Only Connectors

---

---

### HDMI Input and Output

---

Two HDMI mini-connectors on the LHi endplate (full-size HDMI connectors on the KLHi-Box) provide for input and output of HDMI compatible video (version 1.1) and multi-channel embedded audio (8 channels). HDCP is not supported on either input or output. The LHi's HDMI output does not have HDCP, and input sources having HDCP are not supported. The HDMI input is designed to support long cable runs—up to 100 ft. when using 22 or 24AWG HDMI cable, or up to 50 ft. using 28 or 30AWG HDMI cable. The HDMI output supports standard HDMI cables only.

# Chapter 2 – Installation

---

## Installation Overview

---

The installation and set up of a KONA card is simple, and may vary slightly depending on your system.

For the most up-to-date Windows and Mac systems requirements for KONA, see the following on the AJA website:

<https://www.aja.com/page/system-configuration/>

## Unpacking

---

### Shipping Box Contents

---

Your KONA shipment includes:

- KONA PCI-Express card
- KONA I/O cables.

## Installing the KONA Card

---

*Figure 4. KONA Card (model LHe Plus)*

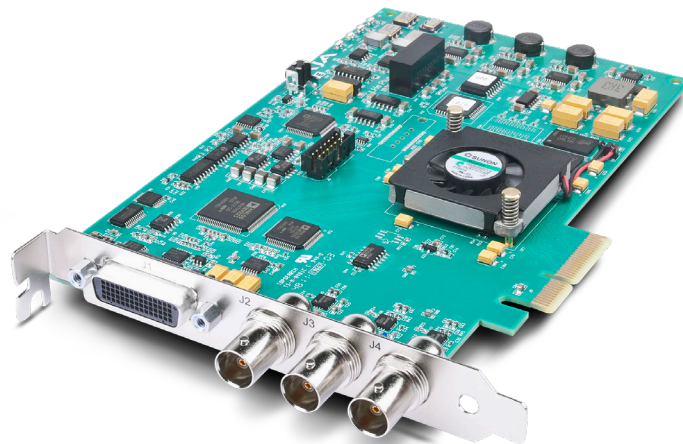

The KONA card can be installed into a PC chassis, legacy Mac Pro chassis with PCIe slots, or into a Thunderbolt PCIe external chassis.

1. Turn off power to the host chassis.
2. Touch the outside of the chassis to discharge any body static.
3. Remove the power cable from the back of the chassis.
4. Open the chassis.
5. Locate a recommended PCIe slot (see the AJA website for slot selection instructions).
6. Remove the backplate and screw from the PCIe slot.

7. Touch the chassis to discharge any body static.
8. Remove the KONA card from its anti-static bag.
9. Carefully insert the card by rocking it slowly into the slot. Ensure the card aligns properly with the slot opening and is fully seated.
10. Replace the screw to secure the card.
11. Close the chassis.
12. Power up the chassis.

*NOTE: Always put a RAID controller and KONA on separate PCIe busses. This improves performance by reducing bus contention.*

## Cabling the System

### KONA LHi Cable Connections

Figure 5. Typical KONA LHi System Shown with Optional KLHi-Box

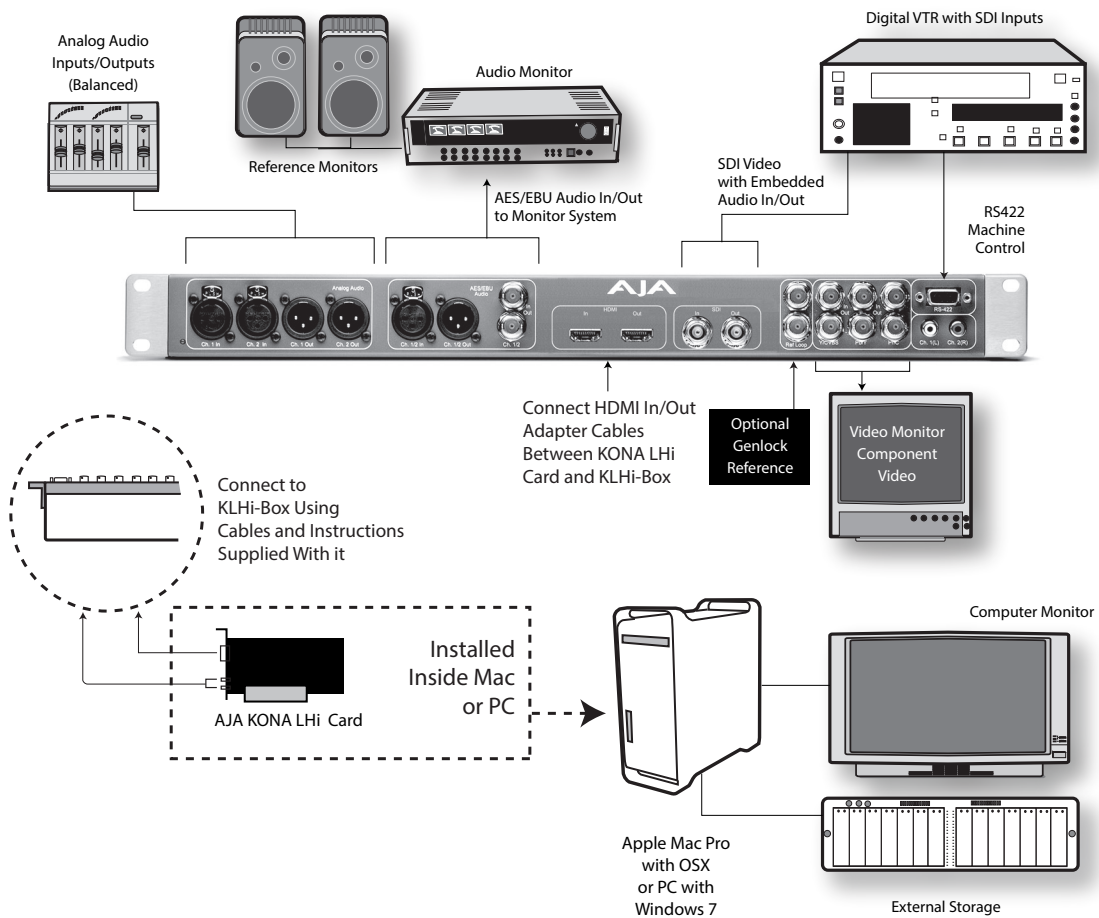

Also see [Figure 1 on page 10](#) for KONA LH cable connector identification.

## Typical System

---

*Figure 5 on page 14* shows typical system interconnections for a system with digital A/V sources. Your system may differ depending on VTRs, audio monitoring, and video monitoring.

1. If desired, connect your house reference sync to the KONA LHi Ref Loop connector (BNC). The second KONA LHi Ref Loop connector on the KLHi-Box (if used) can be connected to the VTR or terminated with a 75-ohm terminator. If instead using LTC timecode input, connect to the Ref Loop input.
2. Connect an HDMI Video Monitor to the KONA LHi HDMI Out connector. Or instead, use the Component Analog Video Out BNC connectors to go to an analog monitor.
3. Connect a 9-pin DE9 machine control cable between your VTR's RS422 control port and the breakout cable's RS-422 machine control connector.
4. Connect two SDI cables between KONA LHi (BNCs are on the card endplate) and your digital VTR (Digital Betacam etc.), one from KONA LHi SDI In to the VTR SDI Out, and one from KONA LHi SDI Out to the VTR SDI In. The KONA LHi SDI connections have embedded audio so the VTR must be configured accordingly.
5. If you have an AES/EBU-ready audio monitoring system, then connect the two channels of AES/EBU output from KONA LHi's XLR connectors (channels 1 and 2) to the monitoring system AES/EBU inputs. If you instead have an analog audio monitoring system, you can use either the XLR balanced audio connectors or the two RCA-style unbalanced stereo output jacks on the Optional KLHi-Box for output.

# KONA LHe Plus Cable Connections

Figure 6. Typical LHe Plus System Shown with Optional KL-Box

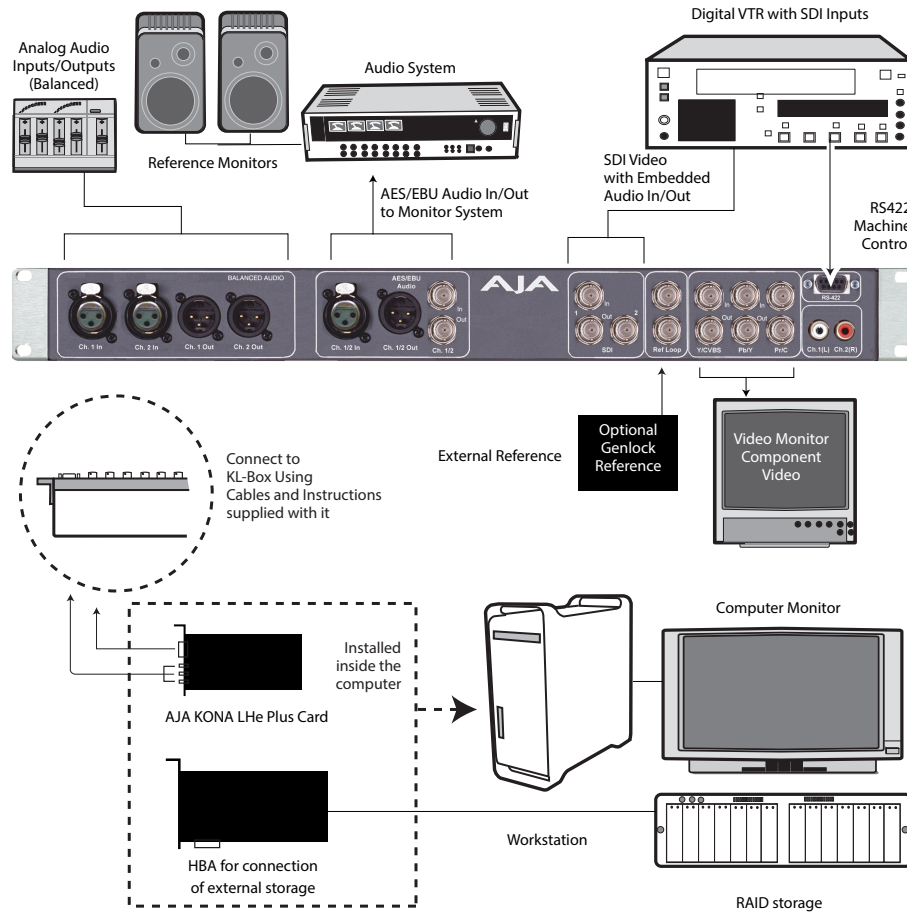

See [Figure 1 on page 10](#) for KONA LH cable connector identification.

## Typical System

[Figure 6 on page 16](#) shows typical system interconnections for KONA LHe Plus with digital A/V sources. Your system may differ depending on VTRs, audio monitoring, and video monitoring.

1. If desired, connect your house reference sync to the KONA LHe Plus Ref Loop connector (BNC). The second KONA Ref Loop connector on the KL-Box (if used) can be connected to the VTR or terminated with a 75-ohm terminator.
2. Connect a Video Monitor to the KONA LHe Plus Component Analog Video Out BNC connectors (preferred), or instead connect to a composite monitor.
3. Connect a 9-pin DE9 machine control cable between your VTR's RS422 control port and the breakout cable's RS-422 machine control connector.
4. Connect two SDI cables between the KONA card (BNCs are on the card endplate) and your digital VTR (Digital Betacam etc.), one from KONA card's SDI In to the VTR SDI Out, and one from card's SDI Out (1 or 2) to the VTR SDI In. The KONA LHe Plus SDI connections have embedded audio so the VTR must be configured accordingly.
5. If you have an AES/EBU-ready audio monitoring system, connect the two channels of AES/EBU output from KONA's XLR connectors (channels 1 and 2) to the monitoring system AES/EBU inputs. If, instead, you have an analog

audio monitoring system, you can use either the XLR balanced audio connectors or the two RCA-style unbalanced stereo output jacks on the Optional KL-Box for output.

## Installing KONA LH Series Software

---

AJA's KONA LH Series software and hardware were developed for powerful integrated video/audio capture, editing, and production with a variety of 3rd-party software. With a KONA LH Series device and a qualified computer, you have the ultimate system for production, post-production, broadcast, and streaming work. AJA software is distributed as a unified package which includes all the software, firmware, plugins, and utility programs for AJA's Io, KONA, and T-TAP Pro products.

Four retail packages are available, one for Mac, one for Windows, and two for Linux (one package for Ubuntu, one package for Rocky Linux).

*NOTE: Support for the Linux OS retail drivers is based on the Linux application used and comes from the application's vendor.*

For a complete software compatibility list, see the AJA website link

<https://www.aja.com/compatibility/kona>

## Installing Software

---

If you're reading this KONA LH Series manual without having downloaded a Desktop Software Installer package in order to open it, then go to the AJA website ([www.aja.com](http://www.aja.com)) and download the **AJA Desktop Software v18.0 Installer**. This includes a package of all the current software for AJA's KONA, Io, and KONA LH Series products, including the AJA Control Panel and AJA Control Room applications, as well as the AJA manuals (user guides) for all of the products supported by this v18 release.

System software updates may occasionally become available on our website ([www.aja.com](http://www.aja.com)). We recommend checking occasionally for both software updates and additional product information.

*NOTE: If your computer has previously had another video capture or multimedia device installed, ensure you uninstall any related software before installing the AJA software package. This will prevent any hardware or software conflicts.*

*IMPORTANT: Before installing the AJA software installer package, ensure that your editing application is installed as detailed in its user documentation. You cannot use KONA LH Series with a third-party application until the application has been installed and run at least once on your workstation. Next, install the AJA software installation package.*

## macOS Installations

---

The products covered in this manual are compatible with Apple systems running macOS versions spanning several generations.

Note that different macOS versions will present specific permissions dialogs during the installation process depending on the version and the specific model of device the AJA Desktop drivers and tools are being installed onto.

*IMPORTANT: As of Desktop Software Installer v18.0, before you run the Installer, and regardless of previous software installations, all users must first run the AJA Uninstaller that is provided in the v18.0 Desktop Software Installer zip. Failure to do so will result in the Desktop Software Installer aborting with an error message.*

For full information on supported devices, versions and AJA software installation procedures, please refer to the **macOS Installation Guide for AJA Desktop Software**, available at the following location:

<https://www.aja.com/support/item/10171>

Release notes for AJA Desktop Software packages will always include the latest information on compatibility with macOS versions and Apple hardware.

## Firmware Update Procedure

After the AJA Software Package has been installed on a computer with your AJA hardware installed, the firmware on that AJA device can be updated if a newer version of firmware is included with that software package.

1. Open the AJA Control Panel application.
2. If more than one AJA device is connected, choose the device you want to update by selecting its name from the drop-down menu at the top of the screen.
3. Go to the Control Panel Firmware Screen.
4. Select the firmware version (if multiple versions exist) in the Desired dropdown.
5. Click on Install. Messages appear and when finished, firmware update completed messages are shown (*Figure 7*).

*Figure 7. Update Completed Messages*

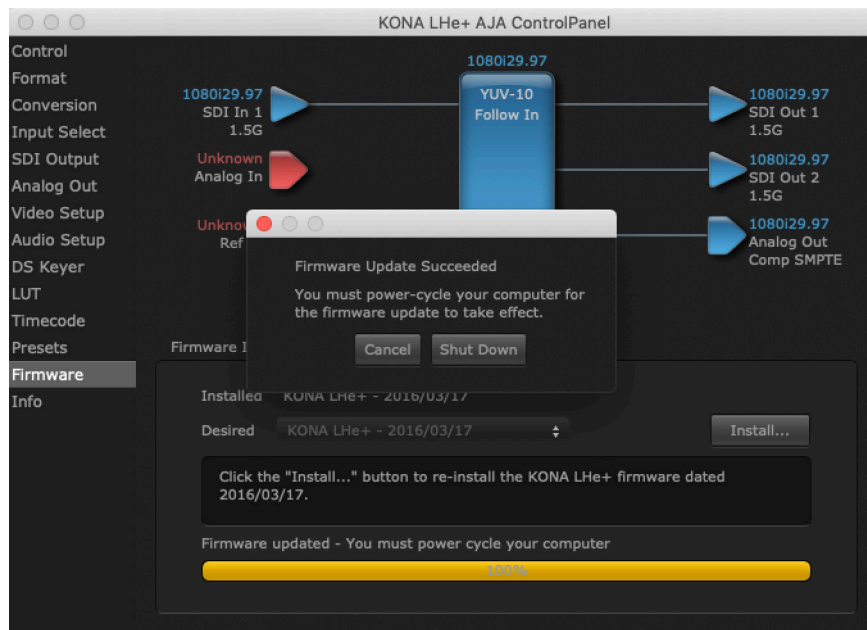

6. Click Shutdown to power down the computer.
7. Restart the computer.
8. Open AJA Control Panel. The AJA hardware with the updated firmware should be recognized by the Control Panel application.

# Chapter 3 – Operation

---



## Using KONA with Professional Video /Audio Software

---

After you install the AJA software package on your computer, you're ready to begin capturing and playing back video and audio using your choice of third-party software. You can go here for AJA software and documentation:

<https://www.aja.com/support/>

For further support information and downloads for third-party software and DirectShow for Developers, go to:

<https://www.aja.com/compatibility/kona>

## Capture Formats

---

When capturing, you can record data in the following file formats:

- BMP
- DPX
- MOV (QuickTime)

*NOTE: Support by KONA of QuickTime for Windows has been discontinued.*

- MXF
- TGA

*NOTE: Other file types can be captured using third-party capture applications such as Sienna, Softron, Tools on Air, Drastic, or Quadrus.*

## AJA Control Panel Overview

---

The AJA Control Panel is a software application that provides a simple visual showing how the KONA hardware is currently configured and allows you to make changes. You can change signal input and output parameters and define the video processing that will be performed.

The AJA software installer automatically installs the Control Panel application on your computer.

## AJA Control Panel Operating Modes

---

AJA Control Panel has two fundamental operating modes.

**Playback Mode** - Used for playing back video files from the computer, usually with a non-linear editing application (NLE) or AJA Control Room, through the KONA card to that card's video/audio outputs for viewing and/or external recording.

**Capture Mode** - Used for capturing video/audio signals that are coming into the KONA card from an external source to create video files on the computer using AJA Control Room or an NLE, or just for display on the KONA outputs. This mode is also used for stand-alone video display or conversion when Control Panel is being used without an external controlling application.

The current KONA operating mode is reported on the Control Panel UI screen, below the block diagram.

## AJA Control Panel User Interface

The AJA Control Panel user interface includes a visual block diagram of the unit's current configuration. The current status, input and output settings, and many other details are depicted in the color-coded block diagram. Below this block diagram are various controls for changing operating parameters, which will vary depending on which function screen has been selected.

The left side of the AJA Control Panel provides a navigation list of available function screens. Clicking on a link (or alternatively, a related element in the block diagram) displays a function screen corresponding to that topic.

Figure 8. AJA Control Panel, Block Diagram and Controls

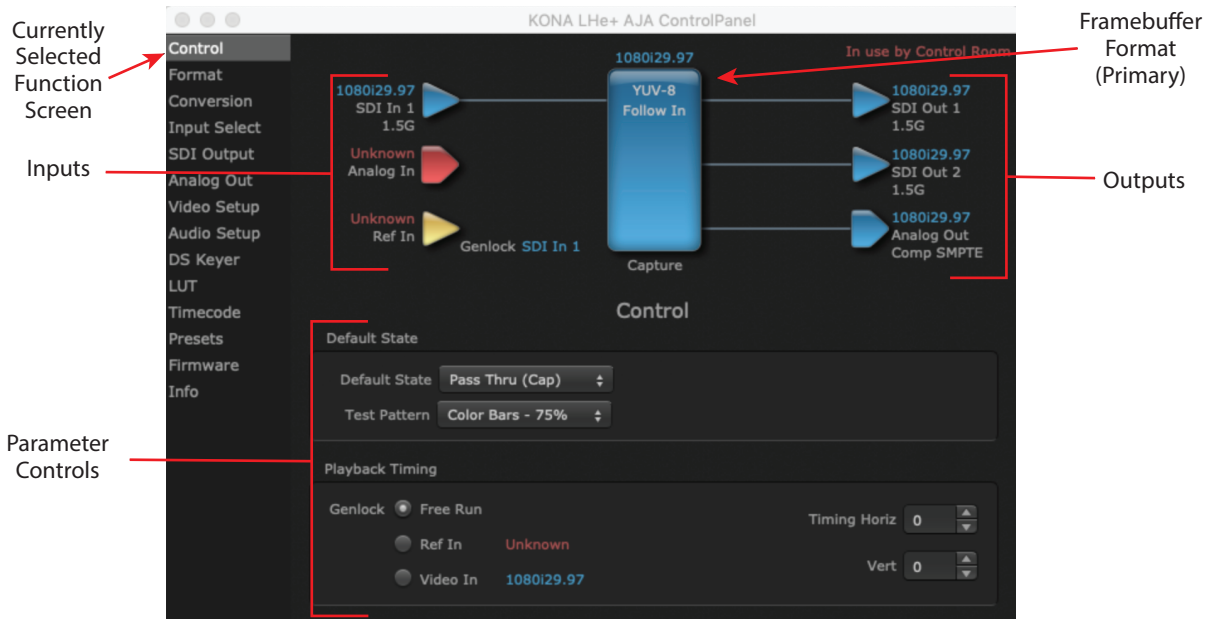

### Block Diagram Area

The top block diagram area of the Control Panel screen is a visual representation of the processing, if any, that's currently occurring, including inputs/outputs, reference source, and system status. Lines between inputs, the framebuffer, and outputs, show a video path. Where there are no lines, there is no connection; this can be because an input or output isn't selected in the Input Select menu. The lines will also show whether the outputs are video or video + key.

You can click any of the function screen selection links in the left column to view its current settings or click on an icon to call up its related settings screen. You can also right-click or Control-click to see context-sensitive information and choices.

Figure 9. Context Sensitive Menu

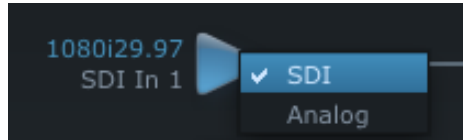

## Color Meanings

---

All items in the AJA Control Panel block diagram are color-coded to show what is happening in real time. This applies to both icons and text. These colors indicate:

Blue

Video is same format as the Primary Format (framebuffer)

Green

Indicates that KONA is performing an active change to the video making it different from the Primary Format (e.g., down-conversion).

Red

The selected operation cannot be performed

Yellow

Reference video (black burst or other reference source)

## Input/Output Icons

---

The input and output icons are triangles that together with their color show all the input and outputs and their status (selected, not selected, input present or not, format, etc.). A complete video path is shown when inputs and outputs are connected with lines going to/from the framebuffer.

Figure 10. Input/Output Icons

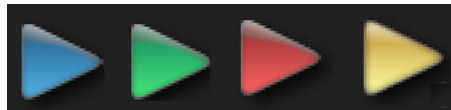

**NOTE:** *Hovering your cursor over an Input or Output icon opens a tooltip that reports that connector's signal status (Input signal detected, Output signal enabled, Input or Output disabled).*

## Framebuffer

---

The framebuffer is the "engine" where your third-party applications interface with the AJA device. The framebuffer has a format (called the "Primary Format") and color space that it follows, as defined in the linked menu screens or via external application software. The "Secondary Format" is a selection for format conversion.

## Device Format

The Device Format is the media format written to disk and used in your project. This is the format that the framebuffer will use and is shown in the Control Panel using the color blue. It is the format that the third-party application software will either receive from the AJA hardware, or is sending to the hardware. All icons in blue are the same as the Device Format used by the framebuffer. Also any text descriptions in the block diagram that appear in blue indicate that something is in the Device Format. For example:

- If the input and output icons are blue, you know that the same format is used throughout the video path. No format conversion is being performed.
- If the input or output icon colors differ (blue input and green output icons for example), you know that a format conversion is being performed.

## Converted Format

Any format other than the currently selected Device Format is a Converted Format. As described previously, this means that either the Inputs or Outputs are somehow different from the framebuffer's assigned format—the Device Format. A conversion is readily apparent because of the color change from blue.

In some cases the application you use with the KONA will automatically set the Device Format, overriding the user's selected Device Format in the AJA Control Panel.

## Conversion Icons

When an input or output is a different standard than the framebuffer, the KONA may be up- down- or cross-converting the signal to the selected standard. This may be automatic, because it's detected an input signal that differs from the standard currently selected, or because you've explicitly told it to convert. In either case, the block diagram will show the conversion by displaying a conversion icon in between the input/output and the framebuffer.

*Figure 11. Up, Down, and Cross-convert Icons*



## Controlling Application

It is important to understand that the computer can contain many applications that can use the AJA device (as you switch from window to window) and it may not always be obvious which currently controls it. In the top right corner, the Control Panel displays the name of the application controlling the unit.

*Figure 12. Control Panel In Use Message (in red)*

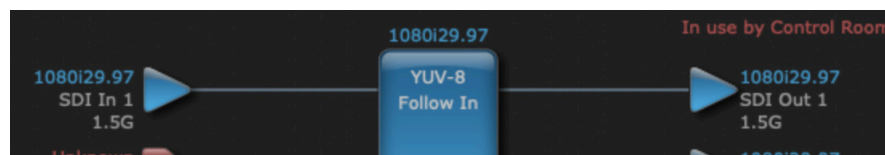

KONA is very flexible and most controlling applications perform the necessary housekeeping so they work correctly when they're active and when they're not. This means that the application that is "active" (in front) will be granted control of the KONA video output. Generally, when you switch to a different application, the previous application lets go of the video output and the new application gets control.

In some cases, however, applications may not always properly "let go" of the I/O interface as another takes over. If this occurs you'll be able to tell by looking at the Control Panel's in use application name.

## Controlling Application Format Selection

---

If a running controlling application uses KONA for capture or output, it controls the Device Format via its own menus and settings. For example, when the Third-party editing application is active (it's the front-most application) and has KONA as its "A/V Device", the KONA's Device Format is determined by the application's "Video Playback" settings. These format selections are reported in the AJA Control Panel block diagram.

Controlling applications can start and stop and change modes—even while they are running. And the behavior of different controlling applications can vary: some applications take control of the interface as soon as they are launched and don't give it up until they quit, while other applications take control of the interface only when they are the "front-most" running application and then relinquish control when they're not. Even these controlling applications may not relinquish control until capture or output operations are completed.

## AJA Control Panel Restart Services

---

AJA Control Panel Restart Services allows for restarting the AJA services if necessary. This can help if various applications begin contesting for access to the Video I/O device. In this situation an **AJA Agent is not running** message can appear as the controlling application status. Hovering your cursor over that message displays a **Restart Agent** button, which clicking on will bring Control Panel back to its startup state. Then an application can freshly acquire control of the I/O device. Currently this feature is only available for macOS installations.

*Figure 13. Restart Services Popup Message*

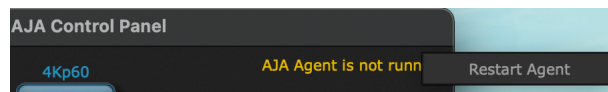

## Control Recommendations

---

We recommend you have the Control Panel running and visible at all times. When the Control Panel is running in the background (not front-most) you can see what the interface is doing and who has control of it.

## Presets

---

Setups can be named and saved as a snapshot (Preset) for recall at any time. You can save various AJA device Control Panel configurations associated with your frequent tasks. You don't have to spend time resetting interface configurations, just load the previously saved Preset for each task. See ["Saving, Loading and Deleting Presets" on page 43](#) for more information.

If you work on multiple systems and want to carry your saved setups to another location, you can copy your saved Preset files on to movable storage and load them into any computer running the AJA Control Panel application.

## macOS Preset Files Storage Location

---

- From the Finder, hold down the Option key (to display the Library directory) and click on Go/Library/Application Support/AJA/<device name>/Presets/

## Windows Preset Files Storage Location

---

- c:\Users\<username>\AppData\Local\AJA\Control Panel\<device name>\Presets\

## Default Preferences

---

When an AJA device starts up, a preference can determine what settings it will have it when it begins to operate. The AJA Control Panel offers two default preference settings:

- Local Preference - A preference stored from the last AJA device's Control Panel settings to be used on next startup of AJA Control Panel. This occurs on next restoration of the default state (triggered by start up of host CPU, startup of the AJA device, or when a third-party application releases the AJA device).
- Global Preference - A preference saved for use as a global default start state for an AJA device that can be shared by multiple users, applied on first startup, or by pressing the Control Panel **Reset Device...** button.

## Local Preference

---

The Local Preference file (com.aja.devicesettings) exists to immediately and automatically store all parameter changes made by a user on a particular AJA device. When any control is changed in the Control Panel, that change is recorded in the Local Preference file stored in a unique location on that computer that is dedicated to that particular device, serial number, and logged-in user. Then, when AJA Control Panel is restarted for any reason, the AJA device being controlled restores the settings being used when Control Panel was last closed.

The Local Preference file can be accessed at the following locations.

On Mac:

- From the Finder, hold down the Option key (to display the Library directory) and click on Go/Library/Preferences/com.aja.devicesettings.

On Windows:

- C:\Users\<USER\_NAME>\AppData\Local\aja\com.aja.devicesettings

*NOTE: Clicking on the AJA Control Panel "Erase All Prefs" button deletes the existing Local Preference file from this location. This file will be recreated as soon as any Control Panel setting is changed.*

*NOTE: Clicking on the AJA Control Panel "Reset Device..." button will delete the existing Local Preference file. If a Global Preference file is found, these settings are reloaded. If a Global Preference file is not found, "factory defaults" are loaded and the device is set to that state*

## Global Preference

---

An administrator can establish a house standard for an AJA device by copying a preference file to a shared computer location. Once placed at that location, it becomes a Global Preference file where it will establish a standard default startup state for all users of that AJA device using that computer system. These settings preempt the initial AJA factory default settings, and are applied when an AJA device is first powered up, or when the Control Panel **Reset Device** button is pressed.

To establish a Global Preference, the administrator first configures the AJA device (which automatically creates a "com.aja.devicesettings" Local Preference file in the location identified above) and then copy or move that file to the correct computer locations (manually or by pushing it out across the network) on all the computers that use the AJA device.

*NOTE: If the user makes changes to an AJA Device's Control Panel settings, those changes are saved to the Local Preference file, which will take priority over the Global Preference file.*

The shared computer locations for a Global Preference file are:

On Mac:

- From the Finder, click on Go/Computer/<System HD>/Users/Shared/AJA/ and copy or move the "com.aja.devicesettings file" described above to this location.

*NOTE: The "AJA" folder needs to be created manually at this location before moving the preference file into it.*

On Windows there are three possible shared locations depending on your system:

- C:\Users\Public\Aja\
- C:\Users\All Users\Aja\
- C:\ProgramData\Aja\

Copy or move the "com.aja.devicesettings file" described above to one of these locations.

*NOTE: The AJA Control Panel Info screen displays the path to the Global Preference file on that computer.*

*NOTE: Clicking on the AJA Control Panel Erase All Prefs button does NOT delete an existing Global Preference file from this location.*

## Function Screens

Listed below are the function screens for KONA and what they are used for.

*Table 1. KONA Function Screens*

<b>Screen</b>	<b>Functions</b>
Control	Configure some basic KONA operation options and output timing.
Format	Select the framebuffer primary video format and any secondary formats for conversion of inputs/outputs
Conversion	Permits selection of a Conversion Format.
Input Select	View and edit input selections and audio mapping.
SDI Output	Select output format.
HDMI	Configure the HDMI I/O (not LHe Plus)
Analog Out	Configure the component format and audio monitor setup.
Video Setup	Configure Video such as composite black level, progressive format and ancillary data (Closed Caption) option.
Audio Setup	Configures Audio options such as analog audio monitor level.
DS Keyer	Setup and control the insertion of keyed video from the framebuffer or graphics files with alpha channel.
LUT	Load a lookup table (LUT) file to adjust the calibration of color for any source.
Timecode	Monitors SMPTE 12M-2 timecode and configure timecode window burn output.

Screen	Functions
Presets	Add or delete saved preset configurations (handy for quick and easy recall of different KONA LH Series settings for varied workflows).
Firmware	Install firmware from your currently installed AJA software package.
Info	Display status information and the firmware version number. This information is generally intended for troubleshooting/support.

## Control Panel Operation

### Control Screen

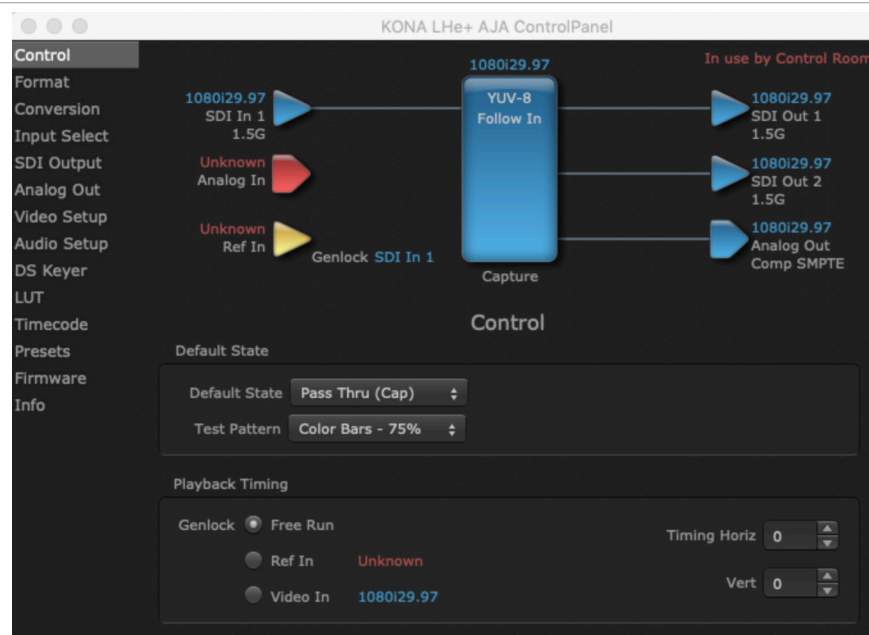

The KONA card can be controlled by various software applications running on a host computer. The Control screen is where you select how the KONA directs video and is used by application software. This screen also provides control for configuring output timing with regard to external reference video and horizontal/vertical delay.

### Default State

This is where you select what the KONA card will output as a default when no application has control of the board, such as when the Mac Finder or Windows Navigation Pane is active. Since KONA can be controlled by software applications as well as Control Panel, the output can change dynamically. When you select many video applications, they will take control of the KONA inputs and outputs. However, when an application that doesn't take control is active, these settings determine what KONA will output.

#### Pass Through (Cap)

This selection directs KONA to route video from its selected input through the card for processing and output, and enables Capture Mode.

*NOTE: Selecting Pass Through (Cap) essentially makes the KONA card a converter. No applications other than the AJA Control Panel need be open to convert audio and video from one format to another. For example, if you need to dub an SD source tape that needs to be HD, the signal can be routed from the SD VTR to the KONA card configured for up-conversion in the AJA Control Panel and then passed through to the HD VTR for recording.*

---

## Test Pattern

This selection directs the KONA card to output a choice of preset pattern when no other application is using the KONA card, and enables Playback Mode. The test patterns you can choose are:

- Black, Color bars (75% or 100%), Ramp, Multiburst, Line Sweep, Multi Pattern, Flat Field, Check Field, White, Border, Linear Ramp, Slant Ramp, Zone Plate, Color Quadrant, Color Quad Border, or 2SI Alignment.

In addition to the preset test pattern choices, a “Load File...” selection at the bottom of the menu allows you to load any standard RGB graphics file (.tif, .psd, etc.) into the framebuffer for display.

*NOTE: The graphic file will not be scaled to fit. If it's smaller than the current framebuffer format, KONA will center it in the frame. If it's larger than the current framebuffer format, it will be cropped on the right and bottom. Also some graphics formats and bit depths may not be supported. Once a graphic file is loaded into the framebuffer it will be retained until it is overwritten by another graphic or test pattern, or when power is turned off. Graphic file names are only “remembered” in the menu until the AJA Control Panel application closes.*

---

## Hold Last App

This selection directs KONA to hold and output the last frame of video from the last application to control KONA. This can be helpful when operating in an environment where you're switching back and forth between multiple application windows.

---

## Playback Timing

Use these controls to set Genlock and Timing adjustment.

---

### Genlock

Selects how KONA will synchronize program video:

- Freerun: In this mode, KONA generates sync without an external reference source
- Ref In: Directs KONA to use the Ref Video source for sync (usually an analog black burst video signal)
- Video In: Directs KONA to use whichever video input source has been selected in the Inputs Screen for sync

*NOTE: For best results when capturing using Avid Media Composer or AJA Control Room, set Ref In to Video In with AJA KONA, AJA Io products and Avid DNxIV, Avid DNxIP.*

---

### Timing (Horiz and Vert):

These two drop-downs allow output timing adjustment with reference to the Ref Video source selected:

- Horizontal selects a number of pixels (clocks) to offset
- Vertical specifies a number of lines to offset

## Format Screen

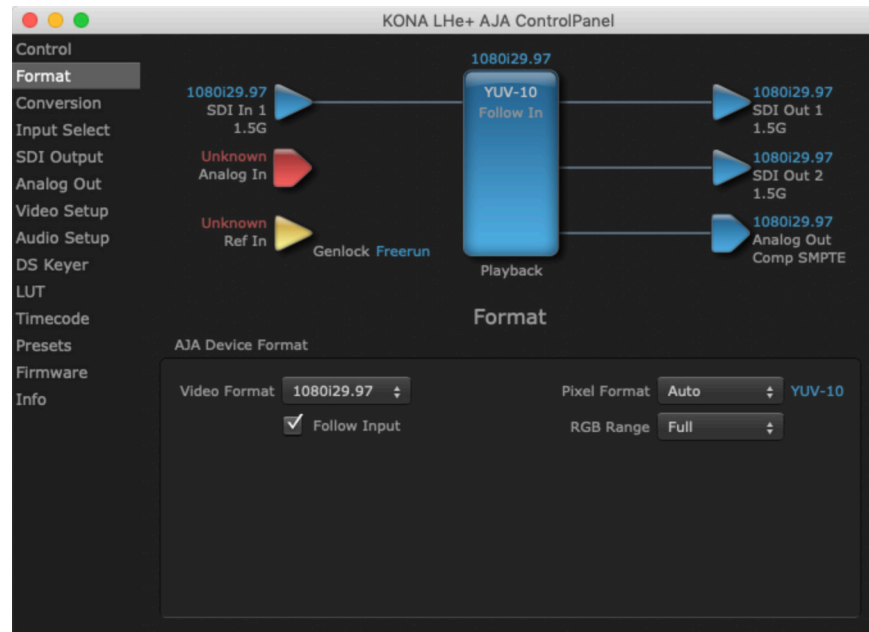

The Format Screen shows the video format currently in use by the KONA framebuffer (called the Primary Format) and allows you to change it. All throughout the Control Panel, choices are always presented based on what KONA can do with the signals available and the inputs/outputs selected. For example, on the Format screen, if the output or inputs are a different format than the primary, then you'll see an additional information pane that allows you to view and edit the secondary format—including control over whether up/down/cross conversion is employed.

## AJA Device Format

### Video Format

This drop-down menu shows the currently selected Device format. If you select an alternate value using the drop-down, it will change the format used by KONA's framebuffer.

When a change is made via the Video Format drop-down or by clicking an icon and selecting a new format via a contextual menu, the block diagram will change to reflect the new format.

### Pixel Format

Use this dropdown menu to choose: YUV-10, YUV-8, RGB-10, or ARGB-8 or RGB-12.

### RGB Range

The RGB Range dropdown menu allows you to select either Auto, Full-range (0-1023) or SMPTE range (typically 64-940) for RGB color output.

**NOTE:** The AJA Control Panel software uses the abbreviation "sf" instead of "PsF" when referring to "progressive segmented frame" formats. In the manual and in other literature you may see either of these acronyms used interchangeably. Visually, it is easier to recognize:

- "sf" for progressively segmented frame formats
- "p" for progressive frame formats

## Follow Input

Enabling the Follow Input checkbox allows the Control Panel Buffer to auto-switch to whatever is the detected input format. This feature works only if the controlling application supports input-based capture—AJA Control Room for example.

## Conversion Screen

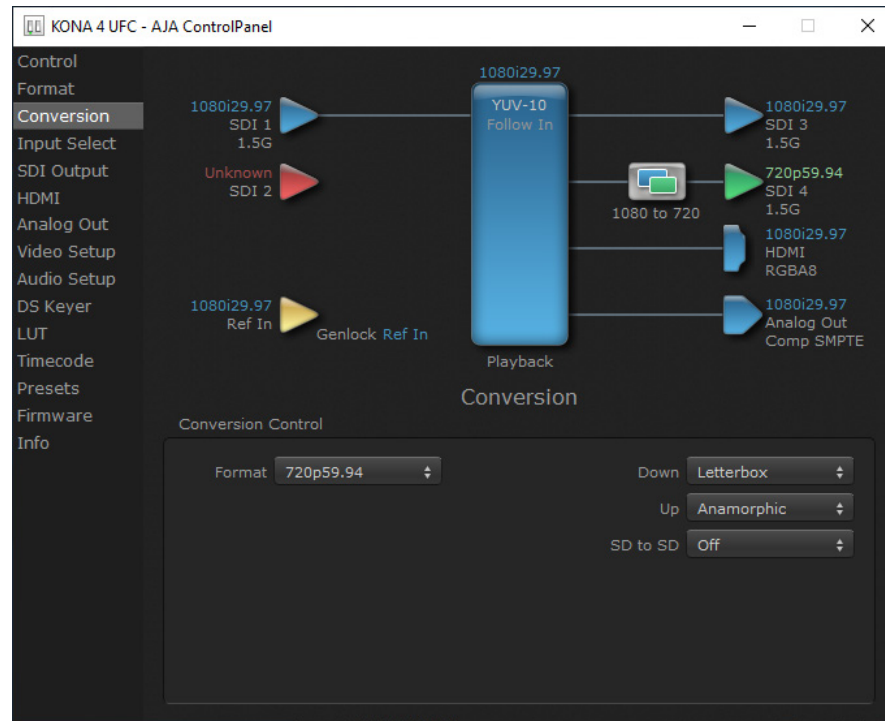

The Conversion Screen allows you to select an alternative Conversion format that can be defined for the KONA card's output.

## Conversion Control

### Format

The Format control shows the currently selected Conversion format. When the Conversion Format is different from the Device Format, a conversion will be performed on the output, and the block diagram changes to reflect the new processing.

The Conversion Formats available can vary based on what the Device Format is and the input signal (frame rates of input sources limits the to/from conversion choices). The drop-down menu lists all compatible formats for selection (incompatible formats are not shown). This allows you to see what you've chosen, and also see those formats that are compatible with the selected Device format.

### Down

For down-conversion the following choices are available:

- Letterbox: image is reduced with black top and bottom added to image area with the aspect ratio preserved
- Crop: image is cropped to fit new screen size
- Anamorphic: full-screen "stretched" image

## Up

The Up and Down drop-down menus are available when conversion has been selected for the video path to/from the framebuffer and identical frame rates are selected (one exception is 1080PsF 23.98, which can be down-converted to 525i 29.97.) Different choices will be available depending on the type of conversion and formats being converted. SD to SD conversions are essentially aspect ratio conversions to accommodate transforming anamorphic images to letterbox or vice versa.

For up-conversion the following choices are available:

- Anamorphic: full-screen “stretched” image
- Pillar box 4:3: results in a 4:3 image in center of screen with black sidebars
- Zoom 14:9: results in a 4:3 image zoomed slightly to fill a 14:9 image with black sidebars
- Zoom Letterbox: results in image zoomed to fill full screen
- Zoom Wide: results in a combination of zoom and horizontal stretch to fill a 16:9 screen; this setting can introduce a small aspect ratio change

## SD to SD

This dropdown is for SD to SD aspect ratio conversion.

- Letterbox: this transforms SD anamorphic material to a letterboxed image
- H Crop: will produce a horizontally stretched effect on the image; transforms anamorphic SD to full frame SD
- Pillarbox: will produce an image in the center of the screen with black borders on the left and right sides and an anamorphized image in the center
- V Crop: will transform SD letterbox material to an anamorphic image

## Input Select Screen

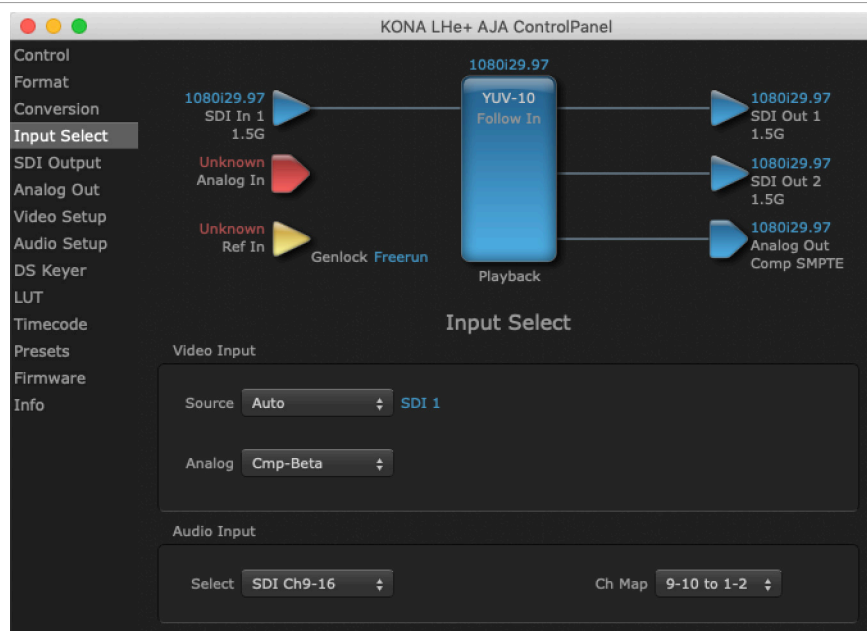

On the Input Select Screen, you can set or view the currently selected video and audio input sources and map audio sources to the channels supported by your editing application. Two information panes in the screen are provided: Video Input and Audio Input.

## Video Input

---

### Source

---

This dropdown menu allows you to select the currently selected video input source. Select from:

- Auto - Automatically selects the source depending on input format
- SDI - Uses the SDI input for the source.
- Analog - Uses the Analog inputs available through the breakout cable.

### Analog

---

Defines the type of analog video input. Select from:

- Composite
- S-Video
- Comp SMPTE
- Comp Beta

## Audio Input

---

### Select

---

This dropdown menu allows you to pick where the audio comes from. KONA supports up to 8 channels of embedded audio. You can choose from the 16 channels embedded in the SDI, which 8 to bring in (1-8 or 9-16). Here, if only two channels were selected in the third-party application you are using, you can select which two channels from the eight embedded will be mapped to that application.

### Ch Map

---

If only two channels were selected in the third-party application you are using, you can select which two channels will be mapped to that application. Different Audio Input selections can have different channel mapping capabilities. Select from:

- 1-2 to 1-2 (default)
- 3-4 to 1-2
- 5-6 to 1-2
- 7-8 to 1-2
- 9-10 to 1-2
- 11-12 to 1-2
- 13-14 to 1-2
- 15-16 to 1-2

*NOTE: This setting does not affect the embedded audio being sent to the KONA LH Series's BNC or HDMI output connectors.*

# SDI Output Screen

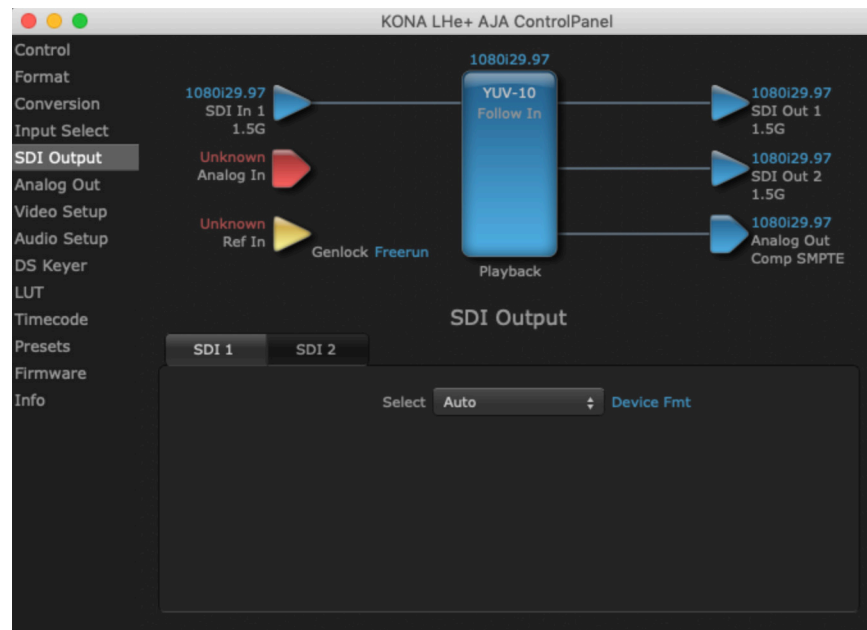

The SDI Out Screen shows the current settings for the SDI output(s). Because the outputs can be configured independently, one output may be the Primary format and the other output may be the Secondary format. If an input/output has no video, it will be indicated on the block diagram (“No Video”).

## SDI 1

### Select

- Auto - Automatically selects the output format, based on the input or selected format.
- Device Format - Selects the framebuffer format for output.
- Converted Format - Selects the conversion format for output.
- Video+Key - (KONA LHe Plus only) When selected, this indicates that the SDI Out 1 video is set to the same format as the framebuffer. SDI Out 2 is set to a video key signal associated with SDI 1 (the shape to be cut out from the video - this will appear as a black and white image/matte). Using the second KONA output as an Alpha Channel key, with the video output, may be useful for feeding production switchers, DVEs or other professional video equipment.

## SDI 2

(KONA LHe Plus only) Same as SDI 1.

## HDMI Screen (LHi\* Only)

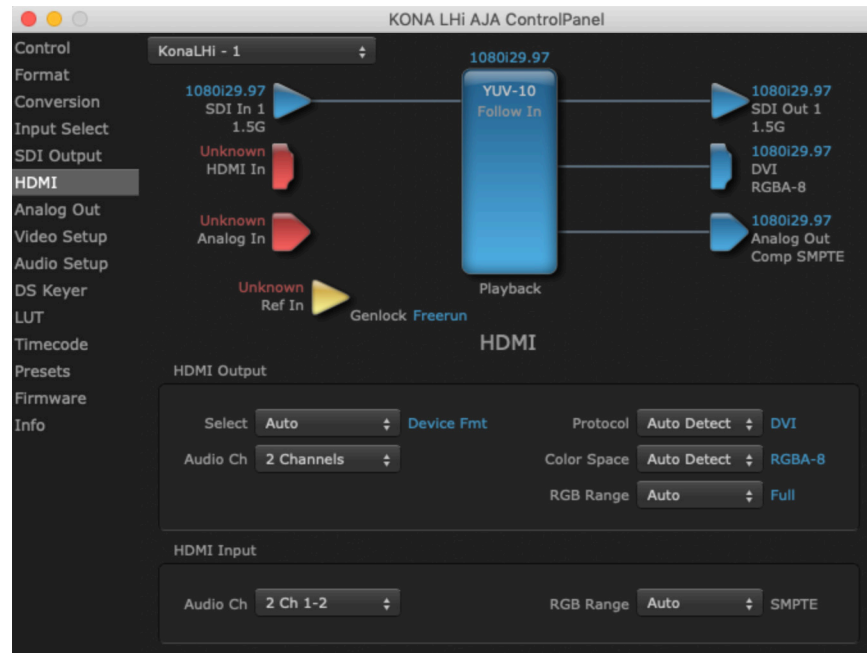

## HDMI Output

### Select

Sets the HDMI output format. Choose from:

- Auto
- Device Format
- Converted Format

### Audio Ch

This dropdown allows you to select the number of embedded audio channels for the HDMI output. Two or eight channels can be chosen.

### Protocol

This pull down allows you to choose between two "Auto" modes, or to explicitly force the output to a desired protocol.

- Auto Detect – (most reliable) AJA device attempts to reconfigure the HDMI output to match the current protocol setting of the output monitor. This option will be the most reliable in creating an output image. However, the output may result in loss of audio.
- Auto Set – (best quality) The AJA device HDMI out will attempt to automatically set the output monitor into the best protocol, usually HDMI.
- HDMI – Forces the use of the HDMI protocol regardless of the attached device's EDID. Connection may fail if output monitor does not support the HDMI protocol.
- DVI – Forces the use of the DVI protocol regardless of the attached device's EDID.

## Color Space

---

This Color Space dropdown allows you to choose between two “Auto” modes, or to explicitly force the output to a desired color space.

- Auto Detect – (most reliable) AJA device attempt to reconfigure the HDMI output to match the current color space setting of the output monitor EDID. This option will be the most reliable in creating an output image. However, the output may result in an inferior image due to color space conversion and loss of bit depth.
- Auto Set – (best quality) The AJA device will attempt to automatically set the output monitor into the best color space and bit depth that matches the user's application needs regardless of EDID of the output monitor. This may result in loss of image if the output monitor does not support a specific color space mode.
- RGBA-8 – Forces the use of RGBA-8 regardless of the attached device's EDID or user application needs.
- RGB-10 – Forces the use of RGB-10 regardless of the attached device's EDID or user application needs.
- RGB-12 – Forces the use of RGB-12 regardless of the attached device's EDID or user application needs.
- YUV-8 – Forces the use of YUV-8 regardless of the attached device's EDID or user application needs.
- YUV-10 – Forces the use of YUV-10 regardless of the attached device's EDID or user application needs.

## RGB Range

---

The RGB Range dropdown menu allows you to select the type of RGB color output.

- Auto
- SMPTE– (typically 64-940)
- Full–(0-1023)

## HDMI Input

---

### RGB Range

---

The detected HDMI input video format is displayed and you're given drop-down menus to configure the RGB range (SMPTE or FULL) as above.

### Audio Ch

---

You can select any two embedded channel pairs from those supplied for stereo output (if applicable). Select from:

- 2 Ch 1-2 through 7-8
- 8 Ch 1-8

# Analog Out Screen

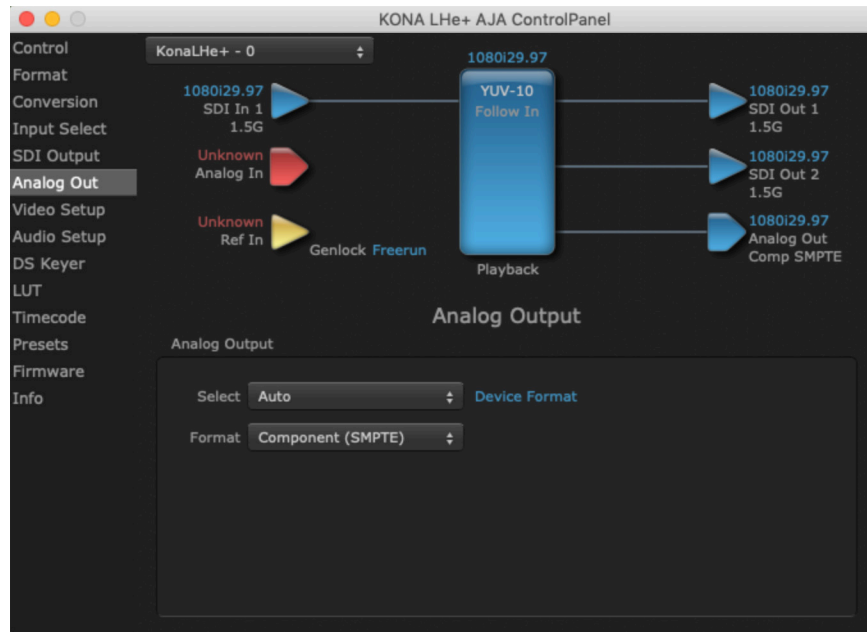

KONA provides a high-quality analog component or composite + Y/C output, generally used for monitoring. This screen shows the current settings for that analog output, and allows you to re-configure it when desired (format and black-level).

## Analog Output

### Select

Select Primary or Secondary (any conversion applied) for the analog output; if a conversion is applied, you'll see the conversion icon appear on the block diagram.

### Format

Select the video format from the Format dropdown.

- Composite + Y/C
- Component (SMPTE)
- Component (Beta)
- Component (RGB)

## Video Setup Screen

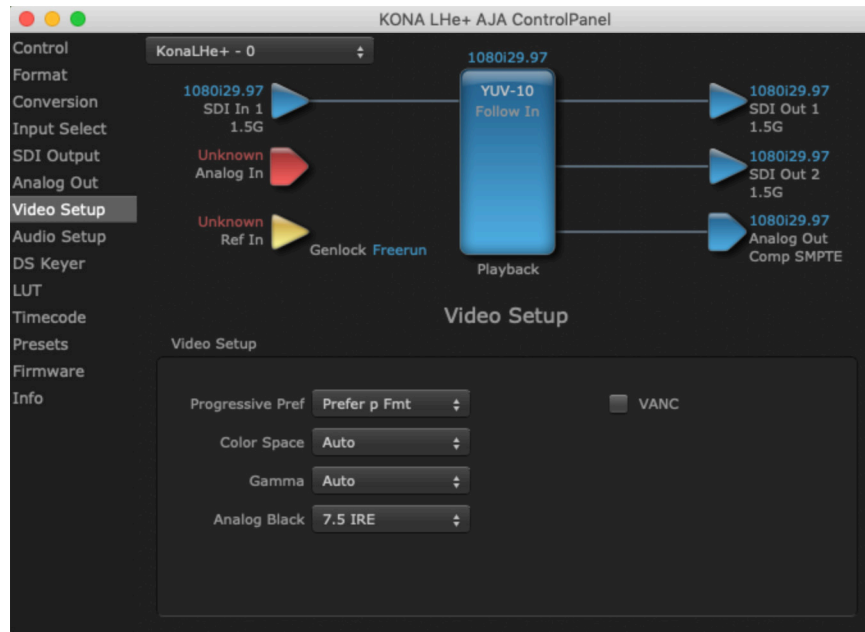

The Video Setup screen shows various other settings which will affect how video inputs and outputs behave, and how KONA interacts with some software applications.

## Video Setup

### Progressive Pref

Allows you to choose to prefer p (progressive frames) or PsF (progressive segmented frames) on non-interlaced output. This feature is used to default the hardware to use either p or PsF output over SDI when it has not been specified by the application.

### Color Space

Sets the video color space. Select from:

- Auto
- Rec 601
- Rec 709

### Gamma

Sets the video gamma. Intended for use with legacy Apple displays. Select from:

- Auto
- Gamma 1.8

### VANC Checkbox

When checked ON, the VANC checkbox tells the KONA card to capture and process any ancillary data in the SDI stream. This can include Closed Captioning data, and other types of metadata. Applications such as Premiere Pro and Final Cut Pro will not capture or output this data through the KONA, if this box is not checked on.

## Audio Setup Screen



The Audio Setup Screen shows the current settings for the analog audio output, allowing you to re-configure it when desired. Different screens are displayed depending on the KONA product.

## Audio Monitor

### Monitor Channels

Use the drop-down menu to select which two audio channels to monitor. Select from Ch 1-2 through Ch 7-8.

*NOTE: This setting only applies to dual channel monitoring environments.*

### Monitor Level

Allows adjustment of the analog monitor level, to match the audio to your operating levels. Select from:

- +24 dBu FSD
- +18 dBu FSD (default)
- +15 dBu FSD
- +12 dBu FSD

## DS Keyer Screen

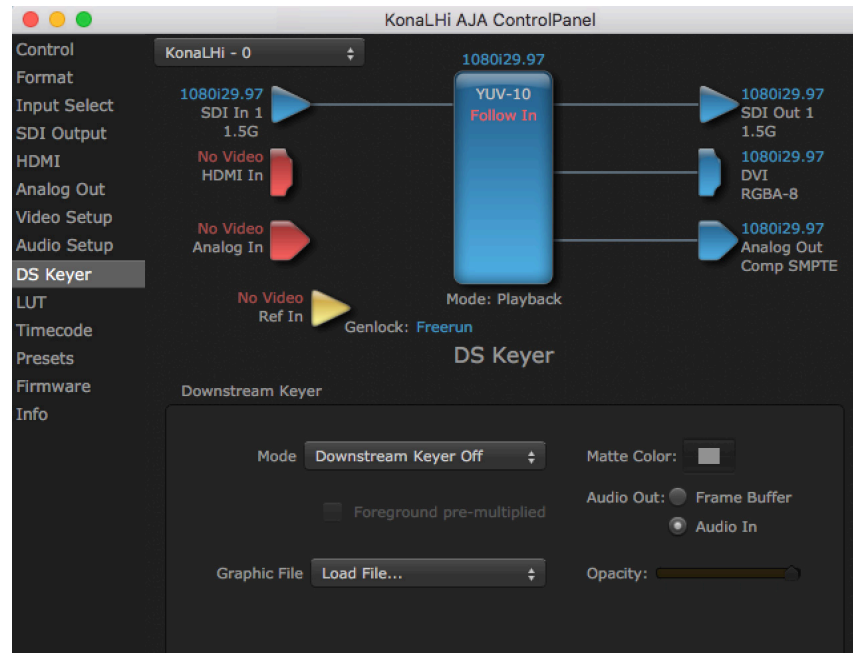

KONA cards have a hardware-based downstream keyer that is ideal for putting logos, “bugs” or other video material with an alpha channel on top of video being played out or printed to tape. A typical application would be putting a television station’s call letters or channel over program video content. Keyed video can be from the KONA’s internal Frame Buffer (from storage, video In, KONA TV, etc.) or from a graphics file that has an alpha channel (PhotoShop etc.).

Settings in the DS Keyer Screen provide control over how the keyer operates and whether it’s turned on or off.

*NOTE: Different controls are available, depending on KONA LH model. For example, Graphic capabilities are available on KONA LHi, but not on KONA LHe plus.*

## Downstream Keyer

### Mode

- Downstream Keyer Off - When this dropdown menu item is selected the downstream keyer will be turned off.
- Frame Buffer over Matte - Places the keyed video with alpha channel currently in the Frame Buffer over a fixed color matte determined by the “Matte Color” setting set separately.
- Frame Buffer over Video In - Places the keyed video currently in the Frame Buffer over the video input for playout or print-to-tape.

The following options are only available with KONA LHi:

- Graphic over Matte - Places a graphics file having an alpha channel (chosen in “Graphic File” dropdown) over a fixed color matte determined by the “Matte Color” setting set separately.
- Graphic over Video In - Places a graphics file having an alpha channel (chosen in “Graphic File” dropdown) over the video input for playout or print-to-tape.
- Graphic over Frame Buffer - Places a graphics file having an alpha channel (chosen in “Graphic File” dropdown) over the current contents of the KONA card’s Frame Buffer (which might be from storage, video In, KONA TV, etc.).

## Matte Color

---

Only available when a Matte setting is selected above, pressing this button brings up a color selection dialog. The dialog provides a variety of ways to select a matte color including a color wheel, color picker (choose from a location anywhere on the computer screen), numeric sliders, swatches, “crayons”, and spectrums. The matte chosen will be used as a video background under the keyed video.

## Foreground pre-multiplied (checkbox)

---

Use to avoid “matte lines” and improve the appearance of the foreground (key) being composited over the background.

## Audio Out

---

- **Frame Buffer** - Select audio out to be routed from the contents of the Frame Buffer.
- **Audio In** - Select audio out to be routed from KONA’s currently selected input(s).

## Opacity

---

This slider controls the transparency of the keyed video (over the background) from translucent to completely opaque.

## Graphic File (LHi Only)

---

### Load File

---

This dropdown allows you to choose from any recently accessed file or select a new file (“Load File...”), which then brings up a file dialogue. Remember that the file raster (pixel x pixel count) should match the primary format in the framebuffer or the secondary format if upconverting. Example: you wish to key a logo on top of your 1920x1080 footage, the still image with alpha channel that you load should be 1920x1080.

*Figure 14. Downstream Keyer Graphic Selection*

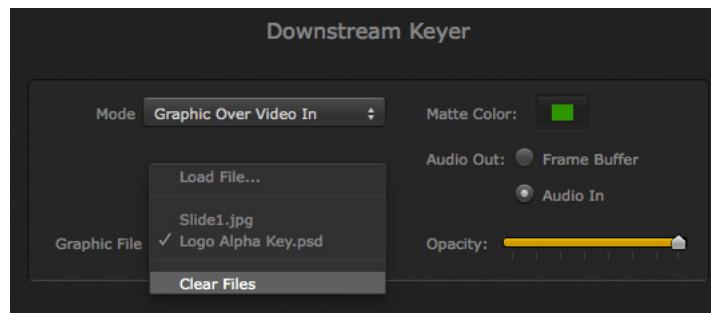

## LUT Screen

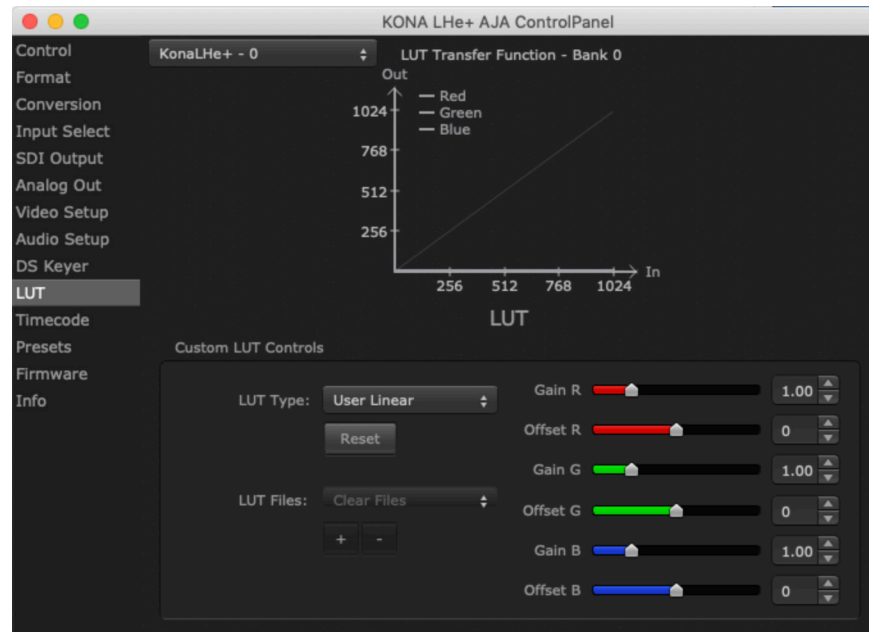

The LUT screen controls allow you to create a custom color look up table (LUT) on the output, for matching a production "look" on a specific display.

Users can also specify their own custom LUTs by creating a LUT file and uploading it to an AJA Video Device using the LUT (lookup table) screen in the Control Panel.

## Custom LUT Controls

The LUT Transfer Function screen displays an approximate representation of the effect of the current LUT settings. When the controls are activated by selecting a User LUT Type, Red, Blue, and Green curves show the transfer functions of each color.

*NOTE: The displayed curves are approximate. Curves for some extreme settings may diverge significantly from the actual transfer functions.*

### LUT Type

Selects the type of LUT. Choose from:

- Auto - LUT will be automatically selected. This setting intelligently applies the type of LUT required in the majority of use cases. For example, if the Frame Buffer is set to SD 608 and the Output set to HD 709, then an industry standard curve for changing 608 to 709 color space is applied.
- Linear - A linear 1:1 LUT is applied, resulting in no color change (every value for source is mapped to the same value for output).
- SMPTE->FullRange - A conversion LUT from SMPTE to Full Range is applied.
- FullRange->SMPTE - A conversion LUT from Full Range to SMPTE is applied.
- User Linear - Activates the Gain and Offset controls, allowing the manual creation of a custom LUT. Initial default setting is linear.

Figure 15. Example LUT Transfer Function Curves

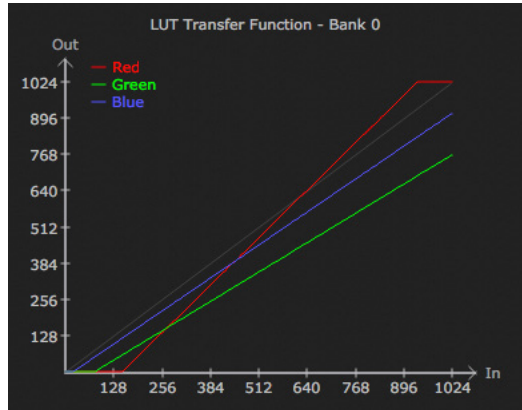

- User Film Stream - Activates the Gain and Offset controls with a default curve matching Grass Valley FilmStream cameras, and also allowing manual creation of a custom LUT.
- User LUT File - See "[LUT Files](#)" below.

### Gain and Offset Controls

---

When activated, the controls on the right allow adjustment of Gain and Offset for Red, Blue and Green.

- Sliders - The sliders on the right can be used to change the values for each color.
- Numeric Entry - You also enter a numeric value by clicking on the displayed number, and can increase or decrease the values clicking on the up/down arrow boxes.
- Cut and Paste - Right clicking on a displayed number opens a Cut, Copy, Paste dropdown menu for convenient numeric entry.

### Reset

---

Clicking on the Reset button resets the currently selected LUT Type to its default values (not active for a User LUT file).

### LUT Files

---

The User LUT File setting above activates the LUT Files dropdown, allowing the selection of a previously saved LUT file. You can create a custom LUT file using most text editors or spread sheets, provided the data is arranged according to the LUT File Format Specification that follows (see "[LUT File Format Specification](#)" on [page 42](#)).

### Uploading Custom User LUT file

---

Once the LUT file is created, you can upload it with the following steps:

1. Before loading a LUT, make sure you are using an RGB/RGBA framebuffer format, and that you have a AJA Video Device that supports LUTs.
2. Open AJA Control Panel and select the "LUT" pane.
3. Click the "LUT Type" popup and choose "User LUT File" menu item. Note "LUT Files" options become enabled.
4. Click the "+" button and use the navigation dialog to choose a custom LUT file. The LUT is now loaded.

## LUT File Format Specification

LUT files are normal text files that contain 1025 lines (numbered 0 - 1024). Each line contains 3 integer values in the range 0 - 1023, representing 10 bit R, G, B component output values. Component values may be separated by one or more commas, spaces, or tabs. The example below show LUT File contents for Line 0, Line 1, Line 2, and Line 1024, with several valid ways to separate the numbers in a line.

- 16, 17, 17
- 17 18 18
- 19 19 21
- 1000, 1022, 1023

In the example above, the first line (Line 0) represents the output values for the case where R=0, G=0, or B=0. In other words, if the R component of a pixel is set to 0, then set R component value to 16. Likewise, if G is set to 0, then set G to 17. The second line (Line 1) does a similar thing for input component values equal to 1.

A simple way to construct a LUT file is to use a Spreadsheet like Excel. Simply fill 3 columns and 1025 rows with LUT data, and save the result as a “CSV” file.

## Timecode Screen

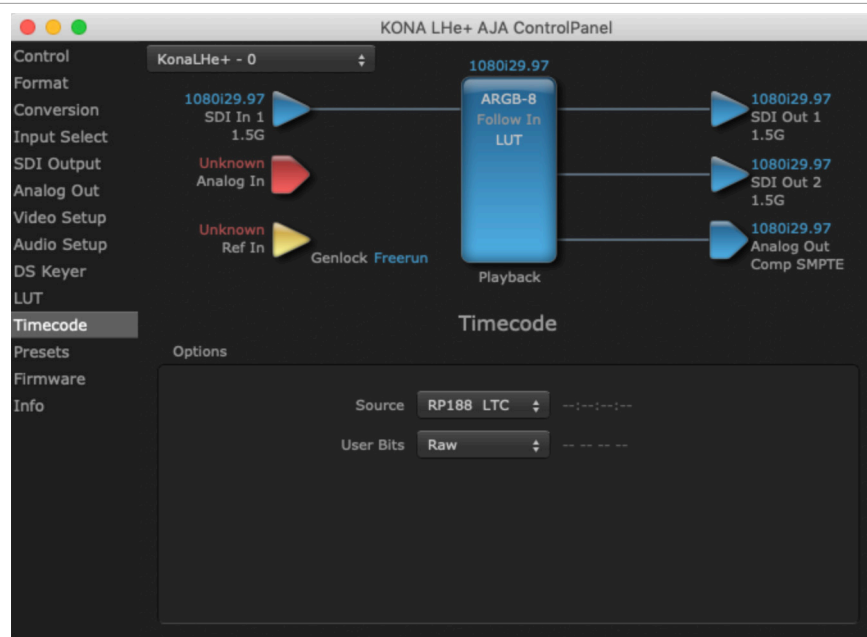

The Timecode Screen selects the timecode stream read for applications that use it (for example, when the timecode source is set to “Use control panel setting,” AJA Control Room will read the selected stream). It is also used for monitoring the RP-188 timecode embedded in the digital data stream).

## Options

### Source

In RP-188 timecode (SMPTE 12M-2) there can be multiple timecode types in the data stream. Use this drop-down to select the one you wish to monitor:

- RP188 LTC (Linear timecode)
- RP188 VITC (Vertical Interval timecode)
- LTC Port input

The selection will be displayed in the timecode value to the right of the drop-down.

### User Bits

Select from Raw or VFR. For monitoring a variable framerate (VFR) timecode (such as Varicam), you may wish to select VFR for User-bits. KONA will detect and interpret the user-bits and display them next to the checkbox. You will see the original framerate (30 fps in the figure below) followed by the adjusted frame padding (two digits reporting discarded and retained frame padding).

*NOTE: SMPTE 12M-2 is the updated name and specification for what was RP-188.*

## Presets Screen

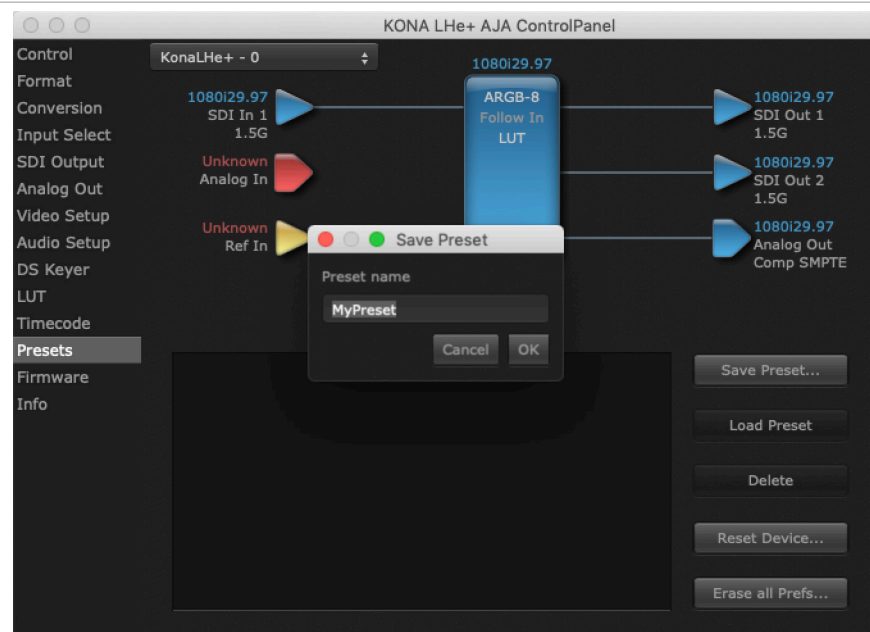

After configuring the AJA Control Panel screens, you can then save all your settings as a snapshot for later recall, called a preset. In this way, you can organize presets for all your typical tasks, eliminating manual reconfiguration.

## Saving, Loading and Deleting Presets

To save a preset, simply go to the Presets screen and click "Save Preset". A dialog will be presented asking you for a file name. Enter a meaningful name and click "OK". Thereafter the preset will be available under the Control Panel "Presets" list.

From the Presets screen you can manage your collection of presets easily. To Load or Delete a stored preset, just select it with your mouse and then click the "Load Preset" or "Delete" button respectively.

## Transferring Saved Presets

If you want to use a saved Preset on another workstation, you can simply copy the file on removable storage and install it at the new location. The Preset files are stored at:

### macOS Preset Files Storage Location

- From the Finder, hold down the Option key (to display the Library directory) and click on Go/Library/Application Support/AJA/<device name>/Presets/

### Windows Preset Files Storage Location

- c:\Users\<username>\AppData\Local\AJA\Control Panel\<device name> Presets\

## Reset to Default

When you click the "Reset Device" button the Default User Preference file will be deleted and AJA Control Panel will do one of the following:

- If a Default Global Preference is found, it is loaded and the device is set to this state.
- If a Default Global Preference file is not found, "factory defaults" are loaded and the device is set to this state.

*NOTE: See "Default Preferences" on page 24 for more information.*

## Firmware Screen

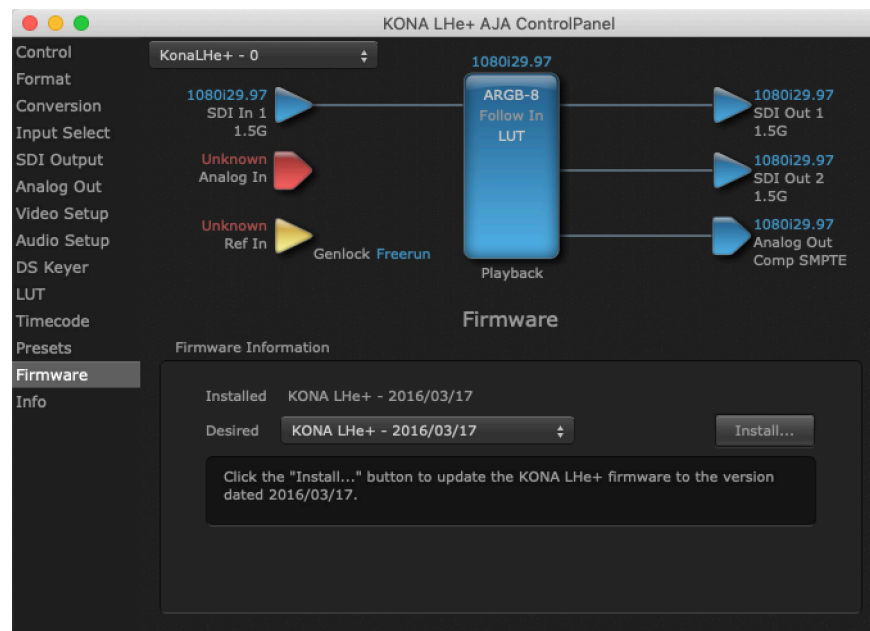

Use the Firmware link to access the firmware update/changeover screen. Click **Install** to erase the current firmware and load the desired firmware.

You will be required to power-cycle your computer to finish the changeover.

See "[Firmware Update Procedure](#)" on page 18 for details.

## Info Screen

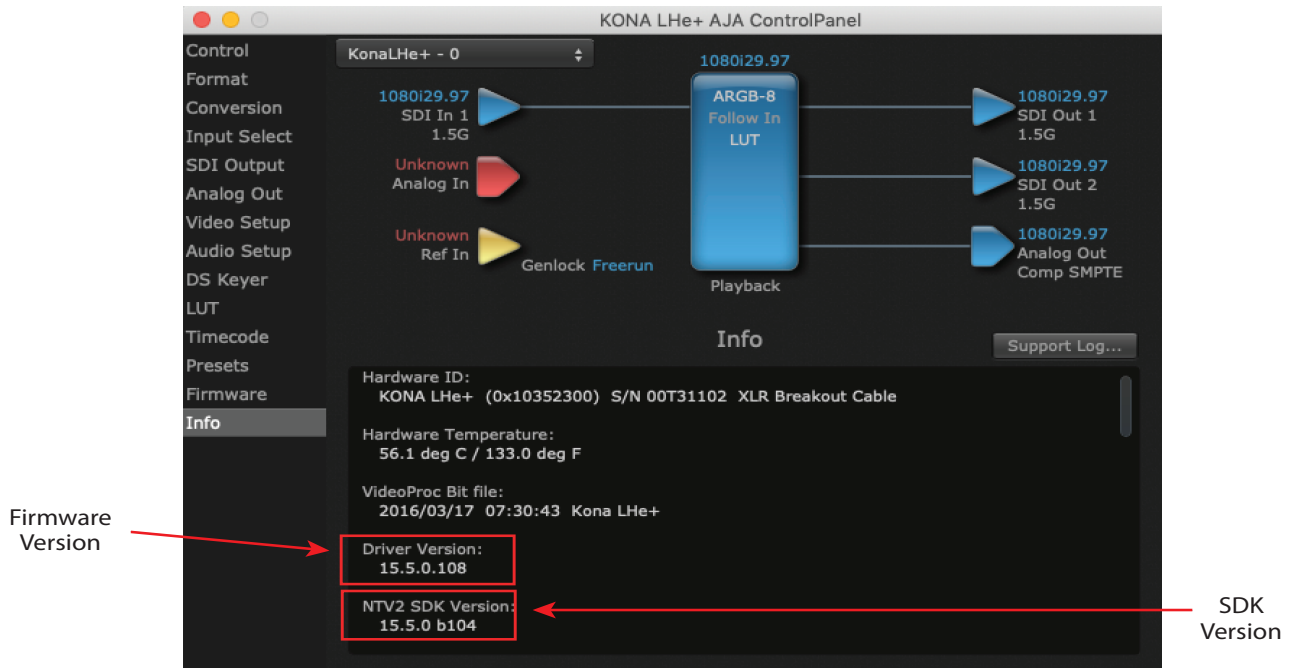

This screen shows the software files that have been installed on your system. This information may be needed if you talk to an AJA Customer Service representative to determine if files are missing or need updating.

The current firmware and SDK versions for the KONA LH Series are shown in the fields specified above.

## Using Multiple AJA Products

More than one AJA product can be used with your host computer. Using the AJA Control Panel application, you can choose which installed product an application uses for input/output. In the upper left corner of the AJA Control Panel application, you will see a board name and the pane heading will read "AJA Control Panel" if you have more than one product and the associated drivers installed (if only one product is installed, you'll see no product or dropdown and the product name will appear in the header). To "target" a specific installed product for use, click on the text in the upper left hand side of the UI and select from the list of available products that appear in the dropdown.

Figure 16. Control Panel Screen Showing Multiple AJA Devices

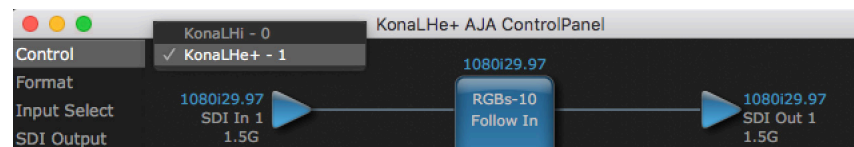

When you launch an application, or AJA Control Panel, the application will use the product that is currently selected in the AJA Control Panel for its input/output. When an application is running, you can change the "targeted" product selection using the Control Panel dropdown menu. The running application will retain

its connection to the product. If you change the “targeted” product and launch a different application, that application will use the new product for its input/output, while the first application you launched will continue to use the other AJA product.

Example: if you select a KONA card as the targeted product in the AJA Control Panel application and launch an Adobe video editing application, that application is now using the KONA card for its input/output. Go back to the AJA Control Panel application and select an Io Express as the “targeted” product. Launch the AJA Control Panel application. AJA Control Panel will now use the Io Express for its output. If you switch back to the Adobe application, you will see that it is still using KONA for its input/output. Note that some applications, like AJA Control Panel, have a provision for playing in the background, so playback on one product could even continue when switching the targeted device for use with another application. In such cases, you can even feed the output from one AJA product to another AJA product on the same system.

*Figure 17. AJA Preferences, Continue Playback when AJA Control Panel is in background*

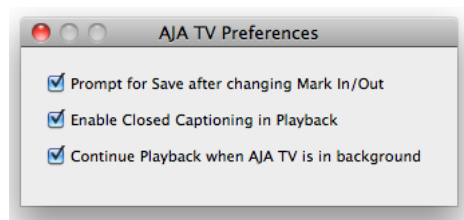

AJA Control Panel optionally supports playback in the background; checkbox Continue Playback when AJA Control Panel is in background.

## Notes on Using Multiple AJA Products:

---

Performance of multi-product use depends on a variety of factors: CPU usage, RAM, disk IOPS/ bandwidth for streams of video, etc. and therefore performance may vary. Also be aware that multiple input/output streams are only supported by software that is explicitly designed for a multi-product environment.

## Additional Information

---

The following information may apply to all the KONA products covered in this manual.

### About 8-bit Versus 10-bit Video

---

While both 8- and 10-bit uncompressed video are capable of providing excellent quality broadcast video, 10-bit represents a significantly higher quality and is preferable in many situations.

Visually, in 8-bit video compared to 10-bit video, you will notice a substantial difference. In 8-bit video there will be “contour lines” or “striations” visible, particularly noticeable in scenes having soft gradients like a ramp or sunset. For example, if a sky region is mostly the same color but varies by only a few digital numbers from one side of the picture to another, you may see contour lines where the signal passes from one digital value to the next higher value.

Since each numerical value in a 10-bit system is only one fourth as large as an 8-bit system’s, these contours become invisible and the sky varies smoothly.

10-bit video is often used when the source and output video (or “master”) is also 10-bit. Even if the input and/or output video is 8-bit, a 10-bit “project” will still maintain a higher quality when there is a significant amount of effects rendering involved.

## About 12-bit Video

---

With the emergence of High Dynamic Range and Wide Color Gamut video, support for even more colors became necessary. 12-bit video theoretically has 4x color resolution of 10-bit video, but current video monitor technology cannot display this full resolution. However, 12-bit video can be useful for postproduction and color grading purposes, as it allows greater control of subtle colors.

## About RGB and YCbCr (YUV) Video

---

KONA supports both YCbCr (also commonly called YUV) and RGB pixel formats. Because the KONA (and SMPTE SDI's) native format is YCbCr, AJA recommends using a YUV Pixel Format. YUV provides headroom for “superwhite” and “superblack”, and these video levels will be clipped when transcoding to RGB. Also, RGB/YUV transcoding involves a level translation that results in mathematical round-off error.

# Appendix A – Specifications

---

## KONA LHi\* Tech Specs

---

### Video Formats

---

- (2K) 2048 x 1080p 23.98, 24, 25
- (2K) 2048 x 1080PsF 23.98, 24
- (HD) 1080i 50, 59.94, 60
- (HD) 1080PsF 23.98, 24
- (HD) 1080p 23.98, 24, 25, 29.97, 30, 50, 59.94, 60
- (HD) 720p 50, 59.94, 60
- (SD) 625i 50
- (SD) 525i 59.94

### Software Dependent Formats

---

- 720p 23.98
- 525i 23.98

Note: These formats are dependent on specific software functionality and are not normal over the wire formats.

### Video Input Digital

---

- 3G-SDI, SMPTE 425
  - YCbCr 4:2:2 10-bit
- 1.5G-SDI, SMPTE 292M
  - Single-Link HD-SDI YCbCr 4:2:2 10-bit
- 270 Mbps SDI, SMPTE 259M-C
  - YCbCr 4:2:2 10-bit, 8-bit
- HDMI v1.3
  - 30-bits/pixel, RGB or YUV, 2.25 Gbps
  - SD, HD, 1080p 50/60 (1x mini-HDMI)

### Video Output Digital

---

- 3G-SDI, SMPTE 425
  - YCbCr 4:2:2 10-bit
- 1.5G-SDI, SMPTE 292M
  - Single-Link HD-SDI YCbCr 4:2:2 10-bit
- 270 Mbps SDI, SMPTE 259M-C
  - YCbCr 4:2:2 10-bit, 8-bit
- HDMI v1.3
  - 30-bits/pixel, RGB or YUV, 2.25 Gbps
  - SD, HD, 1080p 50/60 (1x mini-HDMI)

### Video Input Analog

---

- Composite/S-Video (Y/C) (1x BNC/2x BNC+Adapter)
- NTSC, NTSCJ, PAL
- Component (3x BNC)
- HD: YPbPr, RGB
- SD: YPbPr, RGB (component mode)

- SMPTE/EBU N10, Betacam 525 line, Betacam 525J, RGB
- 12-bit D/A, 8x oversampling
- +/- .2 dB to 5.0 MHz Y Frequency Response
- +/- .2 dB to 1 MHz C Frequency Response
- .5% 2T pulse response
- <1% Diff Phase
- <1% Diff Gain
- <1 ns Y/C delay inequity

## Video Output Analog

---

- Composite/S-Video (Y/C) (1x BNC/2x BNC+Adapter)
- NTSC, NTSCJ, PAL
- Component (3x BNC)
- HD: YPbPr, RGB
- SD: YPbPr, RGB (component mode)
- SMPTE/EBU N10, Betacam 525 line, Betacam 525J, RGB
- 12-bit D/A, 8x oversampling
- +/- .2 dB to 5.0 MHz Y frequency response
- +/- .2 dB to 1 MHz C frequency response
- .5% 2T pulse response
- <1% Diff Phase
- <1% Diff Gain
- <1 ns Y/C delay inequity

## Audio Input Digital

---

- 8-channel, 16 and 24-bit SMPTE-259 SDI embedded audio, 48 kHz sample rate, synchronous
- 8-channel, 16 and 24-bit HDMI embedded audio, 48 kHz sample rate, synchronous
- 2-channel, 16 and 24-bit AES/EBU audio, 48 kHz sample rate, synchronous or nonsynchronous, internal sample rate conversion (via 1x XLR on breakout cable or optional KLHi-Box)

## Audio Input Analog

---

- 2-channel, 16 and 24-bit A/D analog audio, 48 kHz sample rate, balanced (via 2x XLR on DB-25 breakout cable or optional KLHi-Box)
- +24 dBu full scale digital
- +/- 0.2 dB 20 Hz to 20 kHz frequency response

## Audio Output Digital

---

- 8-channel, 16 and 24-bit SMPTE-259 SDI embedded audio, 48 kHz sample rate, synchronous
- 8-channel, 16 and 24-bit HDMI embedded audio, 48 kHz sample rate, synchronous
- 2-channel, 16 and 24-bit AES/EBU audio, 48 kHz sample rate, synchronous or nonsynchronous, internal sample rate conversion (via 1x XLR on breakout cable or optional KLHi-Box)

## Audio Output Analog

---

- 2-channel, 16 and 24-bit D/A analog audio, 48 kHz sample rate, balanced (via 2x XLR on DB-25 breakout cable or optional KLHi-Box)
- +24 dBu full scale digital (0 dBFS)
- +/- 0.2 dB 20 Hz to 20 kHz frequency response
- 2-Channel unbalanced output (via 2x RCA jacks on optional KLHi-Box)

## Up-Conversion

---

- Hardware 10-bit
- Anamorphic: fullscreen
- Pillarbox 4:3: results in a 4:3 image in center of screen with black sidebars
- Zoom 14:9: results in a 4:3 image zoomed slightly to fill a 14:9 image with black side bars
- Zoom Letterbox: results in image zoomed to fill fullscreen
- Zoom Wide: results in a combination of zoom and horizontal stretch to fill a 16:9 screen; this setting can introduce a small aspect ratio change

## Down-Conversion

---

- Hardware 10-bit
- Anamorphic: fullscreen
- Letterbox: image is reduced with black top and bottom added to image area with the aspect ratio preserved
- Crop: image is cropped to fit new screen size

## Cross-Conversion

---

- Hardware 10-bit
- 1080i to 720p
- 720p to 1080i
- 720p to 1080PsF

## SD to SD aspect ratio conversion

---

- Letterbox: This transforms SD anamorphic material to a letterboxed image
- H Crop: Will produce a horizontally stretched effect on the image; transforms anamorphic SD to full frame
- SD Pillarbox: Will produce an image in the center of the screen with black borders on the left and right sides and an anamorphized image in the center
- V Crop: Will transform SD letterbox material to an anamorphic image

## Reference Input

---

- Analog Color Black (1V) or Composite Sync (2 or 4V)
- Looping
- 75 ohm on optional KLHi-Box, terminated on supplied breakout cable

## Electrical Interface

---

- 4-lane PCIe 1.0

## Machine Control

---

- RS-422, Sony 9-pin protocol (via DB-25 breakout cable or optional KLHi-Box)
- 9-pin D-connector pinout is as follows:
  - 1 GND
  - 2 RX-
  - 3 TX+
  - 4 GND
  - 5 No Connection
  - 6 GND
  - 7 RX+
  - 8 TX-
  - 9 GND
  - Shell GND

## Size (w x d x h)

---

- 0.75" x 8.25" x 5.0" (19.05 x 209.55 x 127.00 mm)

## Weight

---

- 0.7 lb (0.4 kg)

## Power

---

- 13W typical, 15W maximum

## Environment

---

- Safe Operating Temperature: 0 to 40 C (32 to 104 F)
- Safe Storage Temperature (Power OFF): -40 to 60 C (-40 to 140 F)
- Operating Relative Humidity: 10-90% noncondensing
- Operating Altitude: <3,000 meters (<10,000 feet)

# KONA LHe Plus Tech Specs

---

## Video Formats

---

- (HD) 1080i 50, 59.94, 60
- (HD) 1080p 23.98, 24, 25, 29.97, 30
- (HD) 1080PsF 23.98, 24, 25, 29.97, 30
- (HD) 720p 50, 59.94, 60
- (SD) 625i 50
- (SD) 525i 59.94

## Video Input Digital

---

- 1.5G-SDI, SMPTE 292M
  - Single Link HD-SDI YCbCr 4:2:2 10-bit
- 270 Mbps SDI, SMPTE 259M-C
  - YCbCr 4:2:2 10-bit, 8-bit

## Video Output Digital

---

- 1.5G-SDI, SMPTE 292M
  - Single Link HD-SDI YCbCr 4:2:2 10-bit
- 270 Mbps SDI, SMPTE 259M-C
  - YCbCr 4:2:2 10-bit, 8-bit

## Video Input Analog

---

- Composite/S-Video (Y/C) (1x BNC/2x BNC+Adapter)
- NTSC, NTSCJ, PAL
- Component (3x BNC)
- HD: YPbPr, RGB
- SD: YPbPr, RGB (component mode)
- SMPTE/EBU N10, Betacam 525 line, Betacam 525J, RGB
- 12-bit A/D, 8x oversampling
- +/- .2 dB to 5.0 MHz Y Frequency Response
- +/- .2 dB to 1 MHz C Frequency Response
- .5% 2T pulse response
- <1% Diff Phase
- <1% Diff Gain
- <1 ns Y/C delay inequity

## Video Output Analog

---

- Composite/S-Video (Y/C) (1x BNC/2x BNC+Adapter)
- NTSC, NTSCJ, PAL
- Component (3x BNC)
- HD: YPbPr, RGB
- SD: YPbPr, RGB (component mode)
- SMPTE/EBU N10, Betacam 525 line, Betacam 525J, RGB
- 12-bit D/A, 8x oversampling
- +/- .2 dB to 5.0 MHz Y Frequency Response
- +/- .2 dB to 1 MHz C Frequency Response
- .5% 2T pulse response
- <1% Diff Phase
- <1% Diff Gain
- <1 ns Y/C delay inequity

## Audio Input Digital

---

- 8-channel, 16 and 24-bit SMPTE-259 SDI embedded audio, 48 kHz sample rate, synchronous
- 2-channel, 16 and 24-bit AES/EBU audio, 48 kHz or 96 kHz sample rate, synchronous or nonsynchronous, internal sample rate conversion (via 1x XLR on breakout cable or optional KL-Box)

## Audio Input Analog

---

- 2-channel, 16 and 24-bit A/D analog audio, 48 kHz sample rate, balanced (via 2x XLR on breakout cable or optional KL-Box)
- +24 dBu Full Scale Digital
- +/- 0.2 dB 20 Hz to 20 kHz frequency response

## Audio Output Digital

---

- 8-channel, 16 and 24-bit SMPTE-259 SDI embedded audio, 48 kHz sample rate, synchronous
- 2-channel, 16 and 24-bit AES/EBU audio, 48 kHz or 96 kHz sample rate, synchronous or nonsynchronous, internal sample rate conversion (via 1x XLR on breakout cable or optional KL-Box)

## Audio Output Analog

---

- 2-channel, 16 and 24-bit D/A analog audio, 48 kHz sample rate, balanced (via 2x XLR on breakout cable or optional KL-Box)
- +24 dBu Full Scale Digital (0 dBFS)
- +/- 0.2 dB 20 Hz to 20 kHz frequency response
- 2-Channel unbalanced output (via 2x RCA jacks on optional KL-Box)

## Down-conversion

---

- Hardware 10-bit
- Anamorphic: fullscreen
- Letterbox: image is reduced with black top and bottom added to image area with the aspect ratio preserved
- Crop: image is cropped to fit new screen size

## Reference Input

---

- Analog Color Black (1V) or Composite Sync (2 or 4V)
- Looping
- 75 ohms on optional KL-Box, terminated on supplied breakout cable

## Electrical Interface

---

- 4-lane PCIe 1.0

## Machine Control

---

- RS-422, Sony 9-pin protocol (via breakout cable or optional KL-BOX)
- 9-pin D-connector pinout is as follows:
  - 1 GND
  - 2 RX-
  - 3 TX+
  - 4 GND
  - 5 No Connection
  - 6 GND
  - 7 RX+
  - 8 TX-
  - 9 GND
  - Shell GND

## Size (w x d x h)

---

- 0.75" x 8.25" x 5.0" (19.05 x 209.55 x 127.00 mm)

## Weight

---

- 0.7 lb (0.4 kg)

## Power

---

- 13W typical, 15W maximum

## Environment

---

- Safe Operating Temperature: 0 to 40 C (32 to 104 F)
- Safe Storage Temperature (Power OFF): -40 to 60 C (-40 to 140 F)
- Operating Relative Humidity: 10-90% noncondensing
- Operating Altitude: <3,000 meters (<10,000 feet)

# Appendix B – Safety & Compliance

---

## Federal Communications Commission (FCC) Compliance Notices

---

### Class B Interference Statement

---

This equipment has been tested and found to comply with the limits for a Class B digital device, pursuant to Part 15, Subpart B of the FCC Rules. These limits are designed to provide reasonable protection against harmful interference in a residential installation. This equipment generates, uses, and can radiate radio frequency energy and, if not installed and used in accordance with the instructions, may cause harmful interference to radio communications. However, there is no guarantee that interference will not occur in a particular installation. If this equipment does cause harmful interference to radio or television reception, which can be determined by turning the equipment off and on, the user is encouraged to try to correct the interference by one or more of the following measures:

- Reorient or relocate the receiving antenna.
- Increase the separation between the equipment and receiver.
- Connect the equipment into an outlet on a circuit different from that to which the receiver is connected.
- Consult the dealer or an experienced radio/TV technician for help.

### FCC Caution

---

This device complies with Part 15 of the FCC Rules. Operation is subject to the following two conditions: (1) This device may not cause harmful interference, and (2) this device must accept any interference received, including interference that may cause undesired operation.

## Canadian ICES Statement

---

### Canadian Department of Communications Radio Interference Regulations

This digital apparatus does not exceed the Class B limits for radio-noise emissions from a digital apparatus as set out in the Radio Interference Regulations of the Canadian Department of Communications. This Class B digital apparatus complies with Canadian ICES-003.

### Règlement sur le brouillage radioélectrique du ministère des Communications

Cet appareil numérique respecte les limites de bruits radioélectriques visant les appareils numériques de classe B prescrites dans le Règlement sur le brouillage radioélectrique du ministère des Communications du Canada. Cet appareil numérique de la Classe B est conforme à la norme NMB-003 du Canada.

## European Union, European Free Trade Association (EFTA) and United Kingdom Regulatory Compliance

---

This equipment may be operated in the countries that comprise the member countries of the European Union, European Free Trade Association and the United Kingdom. These countries, listed in the following paragraph, are referred to as The European Community throughout this document:

AUSTRIA, BELGIUM, BULGARIA, CROATIA, CZECH REPUBLIC, DENMARK, ESTONIA, FINLAND, FRANCE, GERMANY, GREECE, HUNGARY, ICELAND, IRELAND, ITALY, LATVIA, LIECHTENSTEIN, LITHUANIA, LUXEMBOURG, MALTA, NETHERLANDS, NORWAY, POLAND, PORTUGAL, REPUBLIC OF CYPRUS, ROMANIA, SLOVAK REPUBLIC, SLOVENIA, SPAIN, SWEDEN, SWITZERLAND, UNITED KINGDOM

## Declaration of Conformity

Marking by these symbols indicates compliance with the Essential Requirements of the EMC Directive of the European Union 2014/30/EU.



This equipment meets the following conformance standards:

### Safety

EN 62368-1: 2014 + A11 (T-Mark License)  
IEC 62368-1: 2014; (CB Scheme Certificate)

### Emissions

EN 55032: 2012, CISPR 32: 2015,  
EN 61000-3-2: 2014, EN 61000-3-3: 2013

### Immunity

EN 55035: 2017 + A11: 2020, EN 61000-4-2: 2009, EN 61000-4-3: 2006+ A1: 2008 +  
A2: 2010, EN 61000-4-4: 2012, EN 61000-4-5: 2014/A1: 2017, EN 61000-4-6: 2014,  
EN 61000-4-8: 2010, EN 61000-4-11: 2020

The product is also licensed for additional country specific standards as required for the International Marketplace.



**Warning!** This is a Class B product. In a domestic environment, this product may cause radio interference, in which case, the user may be required to take appropriate measures.

**Achtung!** Dieses ist ein Gerät der Funkstörgrenzwertklasse B. In Wohnbereichen können bei Betrieb dieses Gerätes Rundfunkstörungen auftreten, in welchen Fällen der Benutzer für entsprechende Gegenmaßnahmen verantwortlich ist.

**Attention!** Ceci est un produit de Classe B. Dans un environnement domestique, ce produit risque de créer des interférences radioélectriques, il appartiendra alors à l'utilisateur de prendre les mesures spécifiques appropriées.

## Recycling Notice



This symbol on the product or its packaging indicates that this product must not be disposed of with your other household waste. Instead, it is your responsibility to dispose of your waste equipment by handing it over to a designated collection point for the recycling of waste electrical and electronic equipment. The separate collection and recycling of your waste equipment at the time of disposal will help conserve natural resources and ensure that it is recycled in a manner that protects human health and the environment. For more information about where you can drop off your waste for recycling, please contact your local authority, or where you purchased your product.

## Korea KCC Compliance Statement

### 사용자 안내문

이 기기는 업무용 환경에서 사용할 목적으로 적합성평가를 받은 기기로서 가정용 환경에서 사용하는 경우 전파간섭의 우려가 있습니다.

## Taiwan Compliance Statement

警告使用者：  
這是甲類的資訊產品，在居住的環境中使用時，可能會造成射頻干擾，在這種情況下，使用者會被要求採取某些適當的對策。

This is a Class B product based on the standard of the Bureau of Standards, Metrology and Inspection (BSMI) CNS 13438, Class B. In a domestic environment this product may cause radio interference in which case the user may be required to take adequate measures.

## Japan Compliance Statement

この装置は、クラスB情報技術装置です。この装置は、家庭環境で使用することを目的としていますが、この装置がラジオやテレビジョン受信機に近接して使用されると、受信障害を引き起こすことがあります。  
取扱説明書に従って正しい取り扱いをして下さい。 VCCI-B

This is a Class B product based on the standard of the VCCI Council (VCCI 32: 2016). If this is used near a radio or television receiver in a domestic environment, it may cause radio interference. Install and use the equipment according to the instruction manual.

## Translated Warning and Caution Messages

The following caution statements, warning conventions, and warning messages apply to this product and manual.



Warning Symbol



Caution Symbol

## Before Operation Please Read These Instructions



**Warning!** Read and follow all warning notices and instructions marked on the product or included in the documentation.

**Avertissement!** Lisez et conformez-vous à tous les avis et instructions d'avertissement indiqués sur le produit ou dans la documentation.

**Warnung!** Lesen und befolgen Sie die Warnhinweise und Anweisungen, die auf dem Produkt angebracht oder in der Dokumentation enthalten sind.

**¡Advertencia!** Lea y siga todas las instrucciones y advertencias marcadas en el producto o incluidas en la documentación.

**Aviso!** Leia e siga todos os avisos e instruções assinalados no produto ou incluídos na documentação.

**Avviso!** Leggere e seguire tutti gli avvisi e le istruzioni presenti sul prodotto o inclusi nella documentazione.



**Warning!** Do not use this device near water and clean only with a dry cloth.

**Avertissement!** N'utilisez pas cet appareil près de l'eau et nettoyez-le seulement avec un tissu sec.

**Warnung!** Das Gerät nicht in der Nähe von Wasser verwenden und nur mit einem trockenen Tuch säubern.

**¡Advertencia!** No utilice este dispositivo cerca del agua y límpielo solamente con un paño seco.

**Aviso!** Não utilize este dispositivo perto da água e limpe-o somente com um pano seco.

**Avviso!** Non utilizzare questo dispositivo vicino all'acqua e pulirlo soltanto con un panno asciutto.



**Warning!** Do not block any ventilation openings. Install in accordance with the manufacturer's instructions.

**Avertissement!** Ne bloquez aucune ouverture de ventilation. Suivez les instructions du fabricant lors de l'installation.

**Warnung!** Die Lüftungsöffnungen dürfen nicht blockiert werden. Nur gemäß den Anweisungen des Herstellers installieren.

**¡Advertencia!** No bloquee ninguna de las aberturas de la ventilación. Instale de acuerdo con las instrucciones del fabricante.

**Aviso!** Não obstrua nenhuma das aberturas de ventilação. Instale de acordo com as instruções do fabricante.

**Avviso!** Non ostruire le aperture di ventilazione. Installare in conformità con le istruzioni del fornitore.



**Warning!** Do not install near any heat sources such as radiators, heat registers, stoves, or other apparatus (including amplifiers) that produce heat.

**Avertissement!** N'installez pas l'appareil près d'une source de chaleur telle que des radiateurs, des bouches d'air de chauffage, des fourneaux ou d'autres appareils (amplificateurs compris) qui produisent de la chaleur.

**Warnung!** Nicht in der Nähe von Wärmequellen wie Heizkörpern, Heizregistern, Öfen oder anderen Wärme erzeugenden Geräten (einschließlich Verstärkern) aufstellen.

**¡Advertencia!** No instale cerca de fuentes de calor tales como radiadores, registros de calor, estufas u otros aparatos (incluidos amplificadores) que generan calor.

**Aviso!** Não instale perto de nenhuma fonte de calor tal como radiadores, saídas de calor, fogões ou outros aparelhos (incluindo amplificadores) que produzam calor.

**Avviso!** Non installare vicino a fonti di calore come termosifoni, diffusori di aria calda, stufe o altri apparecchi (amplificatori compresi) che emettono calore.



**Warning!** Unplug this device during lightning storms or when unused for long periods of time.

**Avertissement!** Débranchez cet appareil pendant les orages avec éclairs ou s'il est inutilisé pendant de longues périodes.

**Warnung!** Das Gerät ist bei Gewitterstürmen oder wenn es über lange Zeiträume ungenutzt bleibt vom Netz zu trennen.

**¡Advertencia!** Desenchufe este dispositivo durante tormentas eléctricas o cuando no se lo utilice por largos periodos del tiempo.

**Aviso!** Desconecte este dispositivo da tomada durante trovoadas ou quando não é utilizado durante longos periodos de tempo.

**Avviso!** Utilizzare soltanto i collegamenti e gli accessori specificati e/o venduti dal produttore, quali il treppiedi e l'esoscheletro.



**Warning!** Only use attachments and accessories specified and/or sold by the manufacturer.

**Avertissement!** Utilisez seulement les attaches et accessoires spécifiés et/ou vendus par le fabricant.

**Warnung!** Verwenden Sie nur Zusatzgeräte und Zubehör angegeben und / oder verkauft wurde durch den Hersteller.

**¡Advertencia!** Utilice solamente los accesorios y conexiones especificados y/o vendidos por el fabricante.

**Aviso!** Utilize apenas equipamentos/acessórios especificados e/ou vendidos pelo fabricante.

**Avviso!** Utilizzare soltanto i collegamenti e gli accessori specificati e/o venduti dal produttore.



**Warning!** Refer all servicing to qualified service personnel. Servicing is required when the device has been damaged in any way, such as power-supply cord or plug is damaged, liquid has been spilled or objects have fallen into the device, the device has been exposed to rain or moisture, does not operate normally, or has been dropped.

**Avertissement!** Référez-vous au personnel de service qualifié pour tout entretien. L'entretien est exigé quand l'appareil a été endommagé de quelque manière que ce soit, par exemple lorsque le cordon d'alimentation ou la prise sont endommagés, que du liquide a été versé ou des objets sont tombés dans l'appareil, que l'appareil a été exposé à la pluie ou à l'humidité, ne fonctionne pas normalement ou est tombé.

**Warnung!** Das Gerät sollte nur von qualifizierten Fachkräften gewartet werden. Eine Wartung ist fällig, wenn das Gerät in irgendeiner Weise beschädigt wurde, wie bei beschädigtem Netzkabel oder Netzstecker, falls Flüssigkeiten oder Objekte in das Gerät gelangen, das Gerät Regen oder Feuchtigkeit ausgesetzt wurde, nicht ordnungsgemäß funktioniert oder fallen gelassen wurde.

**¡Advertencia!** Consulte al personal calificado por cuestiones de reparación. El servicio de reparación se requiere cuando el dispositivo ha recibido cualquier tipo de daño, por ejemplo cable o espigas dañadas, se ha derramado líquido o se han caído objetos dentro del dispositivo, el dispositivo ha sido expuesto a la lluvia o humedad, o no funciona de modo normal, o se ha caído.

**Aviso!** Remeta todos os serviços de manutenção para o pessoal de assistência qualificado. A prestação de serviços de manutenção é exigida quando o dispositivo foi danificado mediante qualquer forma, como um cabo de alimentação ou ficha que se encontra danificado/a, quando foi derramado líquido ou caíram objectos sobre o dispositivo, quando o dispositivo foi exposto à chuva ou à humidade, quando não funciona normalmente ou quando foi deixado cair.

**Avviso!** Fare riferimento al personale qualificato per tutti gli interventi di assistenza. L'assistenza è necessaria quando il dispositivo è stato danneggiato in qualche modo, ad esempio se il cavo di alimentazione o la spina sono danneggiati, è stato rovesciato del liquido è stato rovesciato o qualche oggetto è caduto nel dispositivo, il dispositivo è stato esposto a pioggia o umidità, non funziona correttamente o è caduto.



**Warning!** Do not defeat the safety purpose of the polarized or grounding-type plug. A polarized plug has two blades with one wider than the other. A grounding type plug has two blades and a third grounding prong. The wide blade or the third prong are provided for your safety. If the provided plug does not fit into your outlet, consult an electrician for replacement of the obsolete outlet.

**Avertissement!** La sécurité de la prise polarisée ou de la prise de type mise à la terre ne doit en aucun cas être empêchée de fonctionner. Une prise polarisée a deux broches, l'une étant plus large que l'autre. Une prise de type mise à la terre a deux broches et une troisième broche pour la mise à la terre. La broche large ou la troisième broche sont fournies pour votre sécurité. Si la prise fournie ne s'insère pas dans votre prise femelle, consultez un électricien pour le remplacement de la prise femelle obsolète.

**Warnung!** Der Sicherheitszweck des gepolten bzw. Schukosteckers ist zu berücksichtigen. Ein gepolter Stecker verfügt über zwei Pole, von denen einer breiter als der andere ist. Ein Schukostecker verfügt neben den zwei Polen noch über einen dritten Pol zur Erdung. Der breite Pol bzw. der Erdungspol dienen der Sicherheit. Wenn der zur Verfügung gestellte Stecker nicht in Ihren Anschluss passt, konsultieren Sie einen Elektriker, um den veralteten Anschluss zu ersetzen.

**¡Advertencia!** No eche por tierra la finalidad del tipo de enchufe polarizado con conexión a tierra. Un enchufe polarizado tiene dos espigas, una más ancha que la otra. Un enchufe con conexión a tierra tiene dos espigas iguales y una tercera espiga que sirve para la conexión a tierra. La espiga ancha, o la tercera espiga, sirven para su seguridad. Si el enchufe suministrado no encaja en el tomacorriente, consulte con un electricista para reemplazar el tomacorriente obsoleto.

**Aviso!** Não anule a finalidade da segurança da ficha polarizada ou do tipo ligação terra. Uma ficha polarizada tem duas lâminas sendo uma mais larga do que a outra. Uma ficha do tipo de ligação à terra tem duas lâminas e um terceiro terminal de ligação à terra. A lâmina larga ou o terceiro terminal são fornecidos para sua segurança. Se a ficha fornecida não couber na sua tomada, consulte um electricista para a substituição da tomada obsoleta.

**Avviso!** Non compromettere la sicurezza della spina polarizzata o con messa a terra. Una spina polarizzata ha due spinotti, di cui uno più largo. Una spina con messa a terra ha due spinotti e un terzo polo per la messa a terra. Lo spinotto largo o il terzo polo sono forniti per motivi di sicurezza. Se la spina fornita non si inserisce nella presa di corrente, contattare un elettricista per la sostituzione della presa obsoleta.



**Warning!** Since the Mains plug is used as the disconnection for the device, it must remain readily accessible and operable.

**Avertissement!** Puisque la prise principale est utilisée pour débrancher l'appareil, elle doit rester aisément accessible et fonctionnelle.

**Warnung!** Da der Netzstecker als Trennvorrichtung dient, muss er stets zugänglich und funktionsfähig sein.

**¡Advertencia!** Puesto que el enchufe de la red eléctrica se utiliza como dispositivo de desconexión, debe seguir siendo fácilmente accesible y operable.

**Aviso!** Dado que a ficha principal é utilizada como a desconexão para o dispositivo, esta deve manter-se prontamente acessível e funcional.

**Avviso!** Poiché il cavo di alimentazione viene usato come dispositivo di sconnessione, deve rimanere prontamente accessibile e operabile.



**Warning!** Protect the power cord from being walked on or pinched particularly at plugs, convenience receptacles, and the point where they exit from the device.

**Avertissement!** Protégez le cordon d'alimentation pour que l'on ne marche pas dessus ou qu'on le pince, en particulier au niveau des prises mâles, des réceptacles de convenance, et à l'endroit où il sort de l'appareil.

**Warnung!** Vermeiden Sie, dass auf das Netzkabel getreten oder das Kabel geknickt wird, insbesondere an den Steckern, den Steckdosen und am Kabelausgang am Gerät.

**¡Advertencia!** Proteja el cable de corriente para que no se le pise ni apriete, en especial cerca del enchufe, los receptáculos de conveniencia y el punto del que salen del equipo.

**Aviso!** Proteja o cabo de alimentação de ser pisado ou de ser comprimido particularmente nas fichas, em tomadas de parede de conveniência e no ponto de onde sai do dispositivo.

**Avviso!** Proteggere il cavo di alimentazione in modo che nessuno ci cammini sopra e che non venga schiacciato soprattutto in corrispondenza delle spine e del punto in cui esce dal dispositivo.



**Warning!** Disconnect the external AC power supply line cord(s) from the mains power before moving the unit.

**Avertissement!** Retirez le ou les cordons d'alimentation en CA de la source d'alimentation principale lorsque vous déplacez l'appareil.

**Warnung!** Trennen Sie die Wechselstrom-Versorgungskabel vom Netzstrom, bevor Sie das Gerät verschieben.

**¡Advertencia!** Cuando mueva la unidad desenchufe de la red eléctrica el/los cable(s) de la fuente de alimentación CA tipo brick.

**Advertência!** Remova os cabos CA de alimentação brick da rede elétrica ao mover a unidade.

**Avvertenza!** Scollegare il cavo dell'alimentatore quando si sposta l'unità.

# 3 Year Warranty and Liability Information

---

## Limited Warranty on Hardware

---

AJA Video Systems, Inc. (AJA Video) warrants that the hardware product, not including storage modules or software components, will be free from defects in materials and workmanship for a period of three years from the date of purchase. AJA Video warrants that the storage modules provided as part of the hardware product will be free from defects in materials and workmanship for a period of one year from the date of purchase. AJA Video provides a separate software warranty as part of the license agreement applicable to software components.

If the Customer brings a valid claim under this limited warranty for a hardware product or storage module (hereafter, a "product") during the applicable warranty period, AJA Video will, at its sole option and as the Customer's sole remedy for breach of the above warranty, provide one of the following remedies:

- Repair or facilitate the repair the product within a reasonable period of time, free of charge for parts and labor.
- Replace the product with a direct replacement or with a product that performs substantially the same function as the original product.
- Issue a refund of the original purchase price less depreciation to be determined based on the age of the product at the time remedy is sought under this limited warranty.

To obtain service under this warranty, the Customer must notify AJA Video of the defect before expiration of the warranty period and make suitable arrangements for the performance of service by contacting AJA Video support through the channels set forth on the support contacts web page at <https://www.aja.com/support>.

Except as stated, the Customer shall bear all shipping, packing, insurance and other costs, excluding parts and labor, to effectuate repair. Customer shall pack and ship the defective product to a service center designated by AJA Video, with shipping charges prepaid. AJA Video shall pay to return the product to Customer, but only if to a location within the country in which the AJA Video service center is located. SOME JURISDICTIONS DO NOT ALLOW THE EXCLUSION OF IMPLIED WARRANTIES OR LIMITATIONS ON APPLICABLE STATUTORY RIGHTS OF A CONSUMER, SO SOME OR ALL OF THE TERMS OF THIS PARAGRAPH MAY NOT APPLY TO YOU.

## Limitation of Liability

---

Under no circumstances shall AJA video BE LIABLE IN ANY WAY FOR ANY LOST, CORRUPTED OR DESTROYED DATA, FOOTAGE OR WORK, OR FOR ANY OTHER INDIRECT, SPECIAL, INCIDENTAL OR CONSEQUENTIAL DAMAGES OR LOST PROFITS, OR FOR ANY THIRD PARTY CLAIM, IN CONNECTION WITH THE PRODUCT, WHETHER RESULTING FROM DEFECTS IN THE PRODUCT, SOFTWARE OR HARDWARE FAILURE, OR ANY OTHER CAUSE WHATSOEVER, EVEN IF AJA VIDEO HAS BEEN ADVISED OF THE POSSIBILITY OF SUCH DAMAGES. AJA VIDEO'S LIABILITY IN CONNECTION WITH THE PRODUCT SHALL UNDER NO CIRCUMSTANCES EXCEED THE PURCHASE PRICE PAID FOR THE PRODUCT. The foregoing limitations apply even if any remedy set forth in this LIMITED WARRANTY fails of its essential purpose. SOME JURISDICTIONS DO NOT ALLOW THE LIMITATION OF LIABILITY FOR PERSONAL INJURY, OR OF INCIDENTAL OR CONSEQUENTIAL DAMAGES, SO SOME OR ALL OF THE TERMS OF THIS PARAGRAPH MAY NOT APPLY TO YOU.

## Governing Law and Language; Your Rights

---

This limited warranty is the only warranty provided by AJA Video on the hardware product. It supersedes all prior or contemporaneous understandings regarding such subject matter. No amendment to or modification of this warranty will be binding unless in writing and signed by AJA Video. The laws of the State of California, USA will govern this warranty and any dispute arising from it. Any translation of this Agreement is intended for convenience and to meet local requirements and in the event of a dispute between the English and any non-English versions, the English version of this warranty will govern. This limited warranty gives you specific legal rights and you may have other rights that vary from jurisdiction to jurisdiction, some of which are noted above.

# AJA Software License Agreement

---

AJA VIDEO SYSTEMS, INC.

THIS IS AN AGREEMENT BETWEEN YOU AND AJA VIDEO SYSTEMS, INC. ("AJA") THAT GOVERNS YOUR USE OF the software ACCOMPANYING THIS LICENSE (E.G., AS installed on the device with which this license is provided).

The "AJA Software" referenced in this Agreement includes all such software, whether made available to you on disk, in read only memory, on any other media or in any other form, and all updates, corrections, enhancements and new versions of such software made available by AJA, together with all related documentation. BY INSTALLING OR USING THE AJA SOFTWARE, YOU ARE AGREEING TO BE BOUND BY THE TERMS OF THIS AGREEMENT. IF YOU DO NOT AGREE TO THE TERMS OF THIS AGREEMENT, DO NOT INSTALL OR USE IT AND, IF APPLICABLE, RETURN THE AJA SOFTWARE TO THE PLACE WHERE YOU OBTAINED IT FOR A REFUND.

1. License Grant. AJA hereby grants you a nonexclusive, personal, non-sublicenseable and limited license to install and use AJA Software on a computer or AJA device. The foregoing license also includes the right to make copies of the AJA Software in machine-readable form for installation and backup purposes only, and provided that each copy you make must include all copyright or other proprietary notices contained on the original.

2. Limitations. You may not decompile, reverse engineer, disassemble, modify, or create derivative works of the AJA Software or any part thereof except to the extent (if any) authorized by applicable law notwithstanding the foregoing restriction. You may not rent, lease, lend, loan, distribute or act as a service bureau or "cloud service" provider with respect to use of the AJA Software or any functionality thereof. THE AJA SOFTWARE IS NOT INTENDED FOR USE IN THE OPERATION OF NUCLEAR FACILITIES, AIRCRAFT NAVIGATION OR COMMUNICATION SYSTEMS, AIR TRAFFIC CONTROL SYSTEMS, LIFE SUPPORT MACHINES OR OTHER EQUIPMENT IN WHICH THE FAILURE OF THE AJA SOFTWARE COULD LEAD TO DEATH, PERSONAL INJURY, OR SEVERE PHYSICAL OR ENVIRONMENTAL DAMAGE.

3. Reservation of Rights. The AJA Software is protected by law, including without limitation copyright law. The AJA Software is licensed, not sold, to you. AJA and its licensors reserve all rights not expressly granted to you by this Agreement. You own the media on which the AJA Software is recorded but AJA and/or AJA's licensor(s) retain ownership of the AJA Software itself. You may not use the AJA Software for any illegal purpose.

4. Transfer. You may make a one-time permanent transfer of all of your license rights to the AJA Software to another person or entity, provided that: (a) you transfer all of the AJA Software, including all its component parts, original media, printed materials and this Agreement; (b) you do not retain any copies of the AJA Software, including any copies stored on a computer or other device; and (c) you transfer the AJA Software subject to this Agreement, and the person or entity receiving the AJA Software accepts the terms and conditions of this Agreement.

5. NFR (Not for Resale) Copies and Add-On Features: Notwithstanding anything to the contrary in this Agreement, (a) AJA Software that is labeled "Not for Resale" or otherwise provided to you on a promotional or demonstration basis may be used only for your demonstration, testing and evaluation purposes and may not be resold or transferred; and (b) AJA may make available certain software components ("Add-On Features") under separate terms and conditions, in which case those separate terms and conditions apply and the Add-On Features are not considered AJA Software under this Agreement.

6. Termination. Your rights in the AJA Software are conditioned on complying with this Agreement, and those rights (together with this Agreement) will terminate automatically, without notice from AJA, if you fail to comply with any term(s) of this Agreement. Upon termination of this Agreement, you must cease all use of the AJA Software and destroy all copies, full or partial, of the AJA Software in your possession or control.

7. Limited Warranty on AJA Software. If you comply with all terms of this Agreement and use the AJA Software in accordance with its documentation, and you install any patches or other updates made available to the AJA Software by AJA, AJA warrants that the AJA Software will perform substantially in accordance with its documentation for a period of ninety (90) days from the date of your original retail purchase. Your exclusive remedy under this warranty will be, at AJA's option, a refund of the purchase

price of the product containing the AJA Software or an update to or replacement of the AJA Software (or applicable component of it). THIS LIMITED WARRANTY AND ANY IMPLIED WARRANTIES ON THE AJA SOFTWARE INCLUDING, BUT NOT LIMITED TO, ANY WARRANTIES OF MERCHANTABILITY, OF SATISFACTORY QUALITY, OR OF FITNESS FOR A PARTICULAR PURPOSE, ARE LIMITED IN DURATION TO NINETY (90) DAYS FROM THE DATE OF ORIGINAL RETAIL PURCHASE. SOME JURISDICTIONS DO NOT ALLOW LIMITATIONS ON HOW LONG A WARRANTY LASTS, SO THE ABOVE LIMITATION MAY NOT APPLY TO YOU. THIS LIMITED WARRANTY GIVES YOU SPECIFIC LEGAL RIGHTS, AND YOU MAY ALSO HAVE OTHER RIGHTS WHICH VARY BY JURISDICTION.

8. Disclaimer of Other Warranties on Aja Software. EXCEPT FOR THE LIMITED WARRANTY ON AJA SOFTWARE SET FORTH ABOVE, AJA AND AJA'S LICENSORS (COLLECTIVELY REFERRED TO AS "AJA" FOR THE PURPOSES OF SECTIONS 8 AND 9) HEREBY DISCLAIM ALL WARRANTIES AND CONDITIONS WITH RESPECT TO THE AJA SOFTWARE, WHETHER EXPRESS, IMPLIED OR STATUTORY, INCLUDING, BUT NOT LIMITED TO, THE IMPLIED WARRANTIES AND/OR CONDITIONS OF MERCHANTABILITY, OF SATISFACTORY QUALITY, OF FITNESS FOR A PARTICULAR PURPOSE, OF ACCURACY, AND OF QUIET ENJOYMENT. FURTHER, AJA DOES NOT MAKE ANY WARRANTY REGARDING NON-INFRINGEMENT OF THIRD PARTY RIGHTS. SUBJECT ONLY TO THE LIMITED WARRANTY SET FORTH IN SECTION 7, YOU EXPRESSLY ACKNOWLEDGE AND AGREE THAT USE OF THE AJA SOFTWARE IS AT YOUR SOLE RISK. AJA DOES NOT WARRANT AGAINST INTERFERENCE WITH YOUR ENJOYMENT OF THE AJA SOFTWARE, THAT THE AJA SOFTWARE WILL MEET YOUR REQUIREMENTS, THAT THE OPERATION OF THE AJA SOFTWARE WILL BE UNINTERRUPTED OR ERROR-FREE, OR THAT DEFECTS IN THE AJA SOFTWARE WILL BE CORRECTED. NO ORAL OR WRITTEN INFORMATION OR ADVICE GIVEN BY AJA OR AN AJA AUTHORIZED REPRESENTATIVE WILL CREATE A WARRANTY. SOME JURISDICTIONS DO NOT ALLOW THE EXCLUSION OF IMPLIED WARRANTIES OR LIMITATIONS ON APPLICABLE STATUTORY RIGHTS OF A CONSUMER, SO SOME OR ALL OF THE TERMS OF THIS PARAGRAPH MAY NOT APPLY TO YOU.

9. Limitation of Liability. TO THE EXTENT NOT PROHIBITED BY LAW, IN NO EVENT WILL AJA BE LIABLE FOR PERSONAL INJURY, OR ANY INCIDENTAL, SPECIAL, INDIRECT OR CONSEQUENTIAL DAMAGES OR LOST PROFITS WHATSOEVER, INCLUDING, WITHOUT LIMITATION, DAMAGES FOR LOSS OF DATA, BUSINESS INTERRUPTION OR ANY OTHER COMMERCIAL DAMAGES OR LOSSES, ARISING OUT OF OR RELATED TO YOUR USE OR INABILITY TO USE THE AJA SOFTWARE, HOWEVER CAUSED, REGARDLESS OF THE THEORY OF LIABILITY (E.G., WHETHER UNDER CONTRACT, TORT OR OTHERWISE) AND EVEN IF AJA HAS BEEN ADVISED OF THE POSSIBILITY OF SUCH DAMAGES. In no event will AJA's total liability to you for all damages (INCLUDING WITHOUT LIMITATION BREACH OF WARRANTY) exceed the amount of fifty dollars (\$50.00). The foregoing limitations will apply even if the any remedy set forth in this agreement fails of its essential purpose. SOME JURISDICTIONS DO NOT ALLOW THE LIMITATION OF LIABILITY FOR PERSONAL INJURY, OR OF INCIDENTAL OR CONSEQUENTIAL DAMAGES, SO SOME OR ALL OF THE TERMS OF THIS PARAGRAPH MAY NOT APPLY TO YOU.

10. Export Law Assurances. You may not use or otherwise export or reexport the AJA Software except as authorized by United States law and the laws of the jurisdiction in which the AJA Software was obtained. In particular, but without limitation, the AJA Software may not be exported or re-exported (a) into (or to a national or resident of) any U.S. embargoed countries, or (b) to anyone on the U.S. Treasury Department's list of Specially Designated Nationals or the U.S. Department of Commerce Denied Persons List or Entity List or any similar legal designation. By using the AJA Software, you represent and warrant that you are not located in, under control of, or a national or resident of any such country or on any such list.

11. Government End Users. The AJA Software including its documentation is a "Commercial Item", as that term is defined at 48 C.F.R. § 2.101, consisting of "Commercial Computer Software" and "Commercial Computer Software Documentation", as such terms are used in 48 C.F.R. § 12.212 or 48 C.F.R. § 227.7202 (or their successors), as applicable. Consistent with these provisions, the AJA Software is licensed to U.S. Government end users (a) only as a Commercial Item and (b) with only those rights as are granted to all other end users pursuant to this Agreement. Unpublished-rights reserved under the copyright laws of the United States.

12. Controlling Law and Severability. This Agreement will be governed by and construed in accordance with the laws of the State of California, as applied to agreements entered into and to be performed entirely within California between California residents. This Agreement will not be governed by the United Nations

Convention on Contracts for the International Sale of Goods, the application of which is expressly excluded. If for any reason a court of competent jurisdiction finds any provision, or portion thereof, to be unenforceable, the remainder of this Agreement will continue in full force and effect.

13. Complete Agreement; Governing Language. This Agreement constitutes the entire agreement between the parties with respect to the use of the AJA Software licensed hereunder and supersedes all prior or contemporaneous understandings regarding such subject matter. No amendment to or modification of this Agreement will be binding unless in writing and signed by AJA. Any translation of this Agreement is intended for convenience and to meet local requirements and in the event of a dispute between the English and any non-English versions, the English version of this Agreement will govern.

# Index

---

## Symbols

- 3rd-Party Plugins 6
- 3 Year Warranty and Liability Information 61
- 8-Bit Video 46
- 10-Bit Video 46

## A

- AJA Agent is not running 23
  - Restart Services 23
- AJA Control Panel 6
- AJA Control Room 6
- AJA Software License Agreement 62
- AJA Software & Utilities 5
- AJA Support 2
- AJA System Test 6
- Analog Black Level
- Analog Output
  - Select 35
- Analog Out Screen
  - Standard Mode 35
- Application
  - Controlling KONA 22
- Audio Ch 33, 34
- Audio Input 31
- Audio Out 39
- Audio Setup 37
- Audio Setup Screen 37

## B

- Block Diagram Area 20
- BMP Format 19
- Breakout Box 10
  - KL-Box 11
  - KLHi-Box 10
- Breakout Cable
  - KONA LHe 10
  - KONA LHi 10

## C

- Capture Formats 19
- Capture Mode 20
- Ch Map 31
- Color Space 34, 36
- Connector Descriptions 11
- Controlling Application 22
- Control Panel 6, 19
  - Block Diagram Area 20
  - Conversion Icon 22
  - Framebuffer 21
  - Input/Output Icon 21
  - UI Colors 21
  - User Interface 20
- Control Panel Restart Services 23
- Control Room 6
- Control Screen
  - Standard Mode 26

- Conversion Icon 22
- Conversion Screen 29
- Converted Format 22
- Custom LUT Controls 40

## D

- Default Preferences 24
- Default State 26
- Delete Preset 43
- Device Format 22
- Disk Storage Methods 7
- Down Conversion 29
- Downstream Keyer Mode 38
- Downstream Keyer Screen
  - Standard Mode 38
- DPX Format 19

## F

- Features
  - KONA LHe Plus 8
  - KONA LHi 7
- Firmware Screen 44
- Firmware Update Procedure 17
- Follow Input 29
- Foreground Pre-Multiplied 39
- Format Screen
  - 28
- Framebuffer
  - Control Panel UI 21

## G

- Gamma 36
- Genlock 27
- Global Preference 24
- Global Preference File Location 25
- Graphic File Load 39

## H

- HDMI Screen (LHi Only) 33
- Hold Last App 27

## I

- Information Screen
  - Standard Mode 45
- Input/Output Icon 21
- Input Select Screen
  - 30
- Installation
  - KONA Card 13

## K

- KL-Box 11
- KLHi-Box 10
- KONA Card
  - Installation 13
- KONA KL-Box 11

- KONA LHe Plus Endplate 10
- KONA LHe Plus Features 8
- KONA LHi Endplate 10
- KONA LHi Features 7
- KONA Models 5

## L

- LHi\* (end of sales) Global Note 5
- Load Preset 43
- Local Preference 24
- Local Preference File 24
- LUT File 40, 41
- LUT File Format Specification 42
- LUT Gain and Offset Controls 41
- LUT Screen 40
- LUT Type 40

## M

- macOS Preset Files Storage Location
  - 24, 44
- Matte Color 39
- Modes of Operation 19
- Monitor Channels 37
- Monitor Level 37
- MOV Format 19
- Multiple AJA Devices 45
- MXF Format 19

## O

- Opacity 39
- Operating Modes 19
- Overview 5

## P

- Pixel Format 28
- Playback Mode 20
- Playback Timing 27
- Preference 24
- Preference File Location
  - Default Global 25
- Preset
  - Delete 43
  - Load 43
  - Save 43
- Preset Files Storage Location 24, 44
- Presets 23
- Presets Screen 43
- Progressive Pref 36
- Protocol 33

## Q

- QuickTime Format 19

## R

- Reset to Default 44
- Restart Services

Control Panel 23  
RGB Range 28, 34

## S

Save Preset 43  
SDI Output Screen  
    Standard Mode 32  
SD to SD Conversion 30  
Select  
    Analog Output 35  
Shipping Box Contents 13  
Snapshot 43  
Software 5  
Software Download 17  
Software Installation 17  
Source  
    Video Input 31  
System Connections  
    KONA LHe 16  
    KONA LHi 14  
System Requirements 6  
System Test 6

## T

Test Pattern 27  
TGA Format 19  
Third-Party Application 17  
Thunderbolt PCIe External Chassis  
    13  
Timecode Screen 42  
Timecode Source 43  
Transferring Saved Presets 44

## U

Up Conversion 30  
Uploading Custom User LUT file 41  
User Bits 43  
Utilities 5

## V

VANC Checkbox 36  
Video+Key 32  
Video Format 28  
Video Input 31  
Video Setup Screen  
    Standard Mode 36