

# KONA X

Capture, Display, Convert



## Installation and Operation Manual

Version 18.0  
Published March 23, 2026



# Notices

---

## Trademarks

---

AJA® and Because it matters.® are registered trademarks of AJA Video Systems, Inc. for use with most AJA products. AJA™ is a trademark of AJA Video Systems, Inc. for use with recorder, router, software and camera products. Because it matters.™ is a trademark of AJA Video Systems, Inc. for use with camera products.

Corvid Ultra®, Io®, Ki Pro®, KONA®, KUMO®, ROI® and T-Tap® are registered trademarks of AJA Video Systems, Inc.

AJA Control Room™, KiStor™, Science of the Beautiful™, TruScale™, V2Analog™ and V2Digital™ are trademarks of AJA Video Systems, Inc.

All other trademarks are the property of their respective owners.

## Copyright

---

Copyright © 2026 AJA Video Systems, Inc. All rights reserved. All information in this manual is subject to change without notice. No part of the document may be reproduced or transmitted in any form, or by any means, electronic or mechanical, including photocopying or recording, without the express written permission of AJA Video Systems, Inc.

## Contacting AJA Technical Support or Sales

---

Please have all pertinent information at hand prior to contacting AJA support or sales.

Support Telephone: +1-530-271-3190

Support Website: <https://www.aja.com/support/contact>

Support Email: [support@aja.com](mailto:support@aja.com)

Sales Email: [sales@aja.com](mailto:sales@aja.com)

Shipping Address: AJA Video Systems  
180 Litton Drive  
Grass Valley, CA 95945, USA

# Contents

---

Notices . . . . .	2
Trademarks . . . . .	2
Copyright . . . . .	2
Contacting AJA Technical Support or Sales . . . . .	2
<b>Chapter 1 – Introduction . . . . .</b>	<b>5</b>
Overview . . . . .	5
KONA X Key Features . . . . .	5
KONA Xpand Key Features . . . . .	6
Application Compatibility . . . . .	6
KONA X Card . . . . .	6
Supported Features . . . . .	6
Capture Formats . . . . .	7
Internal HD/SD Hardware Downstream Keyer . . . . .	7
Cable Connectors . . . . .	7
AJA Software & Utilities . . . . .	8
Installing Software . . . . .	8
macOS Installations . . . . .	8
Mac, Windows and Linux Packages . . . . .	9
Additional with Mac and Windows Packages . . . . .	9
System Requirements . . . . .	10
Disk Storage Methods . . . . .	10
<b>Chapter 2 – Installation . . . . .</b>	<b>11</b>
Installation Overview . . . . .	11
Third Party Software Support . . . . .	11
Unpacking . . . . .	11
Shipping Box Contents . . . . .	11
Installing the KONA X Card . . . . .	12
Cabling the System . . . . .	14
KONA X Example Cable Connections . . . . .	14
KONA X Audio Monitoring . . . . .	14
Installing KONA X Software . . . . .	16
Download . . . . .	16
Software Package Installation and Re-installation . . . . .	16
macOS Installations . . . . .	16
Firmware Update Procedure . . . . .	17
<b>Chapter 3 – Operation . . . . .</b>	<b>20</b>
AJA Control Panel . . . . .	20
AJA Control Panel Operating Modes . . . . .	20
AJA Control Panel User Interface . . . . .	20
Controlling Application . . . . .	23
Presets . . . . .	24
Single-User & Shared Preferences . . . . .	24
Function Screens . . . . .	25
Using Multiple AJA Products . . . . .	26
General Control Panel Operation . . . . .	27
Control Screen . . . . .	27
Format Screen . . . . .	29
Input Select Screen . . . . .	30
SDI Output Screen . . . . .	32
HDMI Screen . . . . .	34
HDR Screens . . . . .	36
Video Setup Screen . . . . .	38
Audio Setup Screen . . . . .	40
Audio Mixer Screens . . . . .	41
Audio Mixer Screen Capture Monitor Tab . . . . .	42
Audio Mixer Screen Playback Monitor Tab . . . . .	43

Downstream (DS) Keyer Screen . . . . .	45
LUT Screen . . . . .	48
Timecode Screen . . . . .	51
Presets Screen . . . . .	52
Firmware Screen . . . . .	54
Info Screen . . . . .	55
About RGB and YCbCr (YUV) Video . . . . .	55
AJA Control Room . . . . .	56
Control Room Overview . . . . .	56
Control Room User Interface. . . . .	56
<b>Chapter 4 – KONA Xpand Card . . . . .</b>	<b>58</b>
Introduction. . . . .	58
KONA Xpand Card Features . . . . .	59
KONA Xpand Cable Options . . . . .	59
Cables between KONA Xpand and KONA X Cards . . . . .	61
KONA Xpand Installation. . . . .	62
Xpand Operation . . . . .	64
KONA Xpand Example System Connections. . . . .	65
<b>Appendix A – Specifications . . . . .</b>	<b>66</b>
KONA X Tech Specs . . . . .	66
<b>Appendix B – Safety &amp; Compliance. . . . .</b>	<b>71</b>
<b>3 Year Warranty and Liability Information . . . . .</b>	<b>78</b>
<b>AJA Software License Agreement . . . . .</b>	<b>79</b>
<b>Index. . . . .</b>	<b>82</b>

# Chapter 1 – Introduction

---

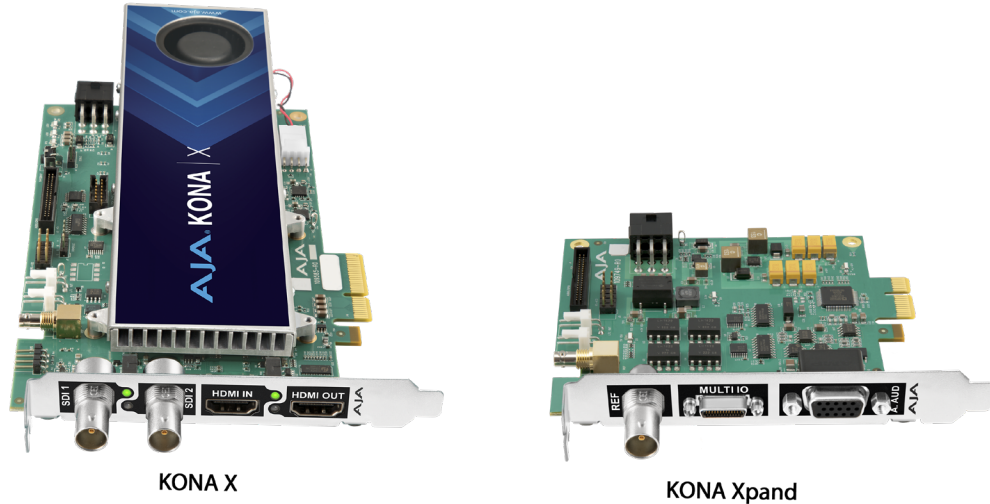

## Overview

---

### KONA X Key Features

---

- Fast, 4-lane PCIe 3.0 I/O card, designed for today's most demanding video and audio workflows.
- Works with HFR 4K/UltraHD, 2K/HD, SD, Deep Color and/or HDR.
- Supports 10-bit 4:2:2 and 4:4:4, or 12-bit\* color spaces for pristine imagery.
- Dual 12G, full size BNC, bi-directional 12G-SDI connections.
- Dual full-size HDMI connections, one for input and one for output.
- Streaming DMA (Direct Memory Access) API - Application developers can bypass on-card memory and pass data directly between the video I/O and computer buffer. This enables applications that support this API to achieve as low as sub-frame latencies, and a better method of dealing with dynamic video (wandering frame rates, etc.)
- VESA HDMI I/O Support - Support for VESA Computer Display Monitor Timing (DMT) enables the video subsystem to be more agnostic w/ respect to video timing, thus allowing capture and playback of many more HDMI formats. This allows HDMI outputs from computer and video game devices.
- Flexibility to ingest and output with 12G/6G/3G-SDI and monitor with a full-size HDMI 2.0 port.
- Bidirectional 12G-SDI ports provide flexibility for capture and simultaneous pass through, and with the appropriate software, multi-channel capture and streaming.
- For HDR workflows, KONA X supports HDR10 and HLG for rich color delivery over HDMI 2.0.
- KONA X supports Dolby Vision HDR with the appropriate third party software.
- Three year warranty
- Operates with (optional) KONA Xpand IO expansion board

*NOTE: \*Bit depth is application dependent.*

## KONA Xpand Key Features

---

- The (optional) KONA Xpand card mounts in an adjacent PCIe slot.
- KONA Xpand includes additional circuitry required for analog audio, reference, balanced AES/EBU audio, GPIO, balanced analog audio, LTC in and LTC out.

*NOTE:* See "[KONA Xpand Card](#)" on page 58.

## Application Compatibility

---

The KONA X card brings the highest quality 4K/UltraHD, 2K, HD, and SD video and audio to computers running Mac, Windows or Linux Operating Systems. The KONA X card supports a range of creative software for editorial, color, mastering, HDR, dailies, live streaming, graphics, game capture and more.

KONA X cards have wide application compatibility. Out-of-the-box, your KONA X hardware and software supports Adobe Premiere Pro, Adobe After Effects, Apple Final Cut Pro X, Avid Media Composer, Avid ProTools and Telestream Wirecast via AJA's unified Desktop Software package.

AJA hardware is also supported by a range of additional applications for all types of video, graphics and effects work, via the support of third party development partners. Pick your application of choice and KONA X connects it to your world.

<https://www.aja.com/compatibility/kona>

## KONA X Card

---

### Supported Features

---

- 4K/UltraHD/2K/HD/SD up to 50/60p
- 2x bidirectional 12G-SDI with up to 16-channels of embedded audio
- HDMI 2.0 input and output with up to 8-channels of embedded audio
- RGB 4:4:4 12-bit (4K/UltraHD) workflows supported
- YCbCr 4:2:2 10-bit and HFR workflows supported
- VESA HDMI I/O compatibility - the video subsystem timing is agnostic, enabling capture and playback of a myriad of HDMI formats
- Support for Apple Final Cut Pro, Adobe Premiere Pro and Avid Media Composer and much more
- Support for OEM applications with the AJA SDK
- In Firmware Microcontroller for OEM use
- 4K Closed Caption Support
- VPID signaling for SDR/HDR Transfer Characteristics, Colorimetry and Luminance via SDI
- PQ, HLG, HDR10, HDR10+ and Dolby Vision Support
- HDR Metadata Capture and Auto Playback Detection
- Includes support for the latest Apple silicon
- HD/SD hardware keyer that for placing graphic files with alpha channel over HD/SD video, in a selectable matte, or the contents of the card's framebuffer from a software application
- Optional KONA Xpand board provides Bi-level / Tri-level Video Reference (BNC), LTC in/out, 8-channels AES/EBU audio (all with included breakout cable) and 2-channels Analog Audio in and out (via user supplied DB-15 to XLR cable)

*NOTE:* See "[KONA Xpand Card](#)" on page 58.

## Capture Formats

When capturing, you can record data in the following file formats:

- BMP
- DPX
- MOV (QuickTime)
- MP4

*NOTE: Support of QuickTime for Windows has been discontinued. However, ProRes family capture and playback for macOS, Windows and Linux is supported via AJA Control Room.*

- MXF
- TGA

*NOTE: Other file types can be captured using third party capture applications such as Sienna, Softron, Tools on Air, Drastic, or Quadrus.*

## Internal HD/SD Hardware Downstream Keyer

KONA X cards have a powerful HD/SD hardware keyer that can place graphic files with an alpha channel over HD/SD video in a selectable matte or the contents of the card's framebuffer from a software application.

- Key a bug or text over picture and avoid what might normally be a lengthy software render.
- Key video that has an alpha-channel over video input or a matte.
- The downstream keyer operates with HD/SD video; it is not available for UltraHD/4K signals.

*NOTE: See "Downstream (DS) Keyer Screen" on page 45*

## Cable Connectors

*Figure 1. KONA X Card cable connections*

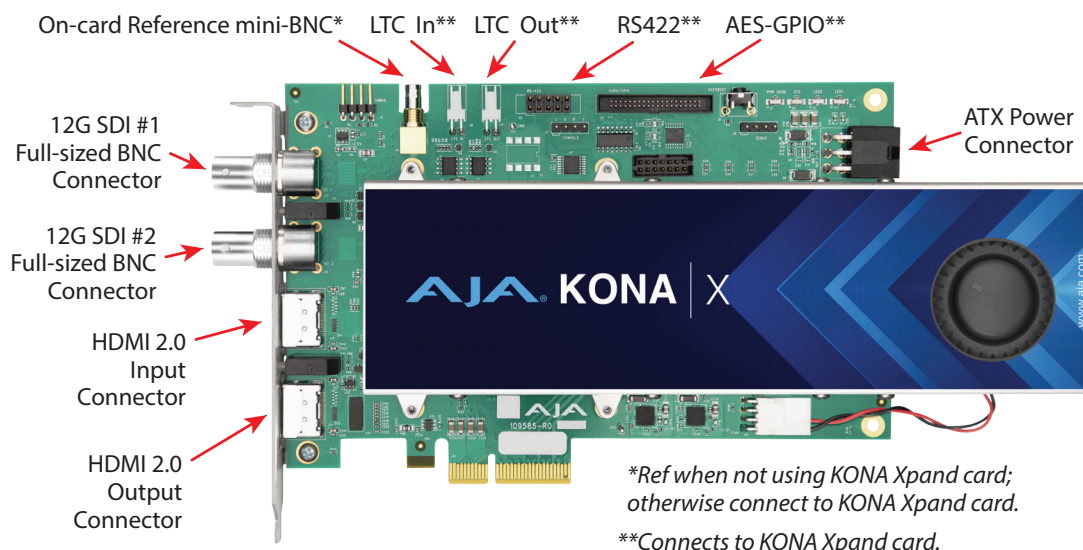

*NOTE: For further information on KONA X cable connections, see "KONA X Example Cable Connections" on page 14.*

*NOTE: For further information on KONA X to KONA Xpand cable connections, see "Cables between KONA Xpand and KONA X Cards" on page 61.*

# AJA Software & Utilities

---

AJA's KONA X software and hardware were developed for powerful integrated video/audio capture, editing, and production with a variety of 3rd-party software. With KONA X and a qualified computer, you have the ultimate system for production, post-production, broadcast, and streaming work. AJA Software is distributed as a unified package which includes all the software, firmware, plugins, and utility programs for AJA's Io, KONA, and T-TAP Pro products.

Four retail packages are available, one for Mac, one for Windows, and packages for Ubuntu and Rocky Linux.

*NOTE: Support for the Linux OS retail drivers is based on the Linux application used and comes from the application's vendor.*

For a complete software compatibility list, see the AJA website link

<https://www.aja.com/compatibility/kona>

## Installing Software

---

If you're reading this KONA X manual without having downloaded a Desktop Software Installer package in order to open it, then go to the AJA website ([www.aja.com](http://www.aja.com)) and download the **AJA Desktop Software v18.0 Installer**. This includes a package of all the current software for AJA's KONA, Io, and KONA X products, including the AJA Control Panel and AJA Control Room applications, as well as the AJA manuals (user guides) for all of the products supported by this v18 release.

System software updates may occasionally become available on our website ([www.aja.com](http://www.aja.com)). We recommend checking occasionally for both software updates and additional product information.

*NOTE: If your computer has previously had another video capture or multimedia device installed, ensure you uninstall any related software before installing the AJA software package. This will prevent any hardware or software conflicts.*

*IMPORTANT: Before installing the AJA software installer package, ensure that your editing application is installed as detailed in its user documentation. You cannot use KONA X with a third-party application until the application has been installed and run at least once on your workstation. Next, install the AJA software installation package.*

## macOS Installations

---

The products covered in this manual are compatible with Apple systems running macOS versions spanning several generations.

Note that different macOS versions will present specific permissions dialogs during the installation process depending on the version and the specific model of device the AJA Desktop drivers and tools are being installed onto.

*IMPORTANT: As of Desktop Software Installer v18.0, before you run the Installer, and regardless of previous software installations, all users must first run the AJA Uninstaller that is provided in the v18.0 Desktop Software Installer zip. Failure to do so will result in the Desktop Software Installer aborting with an error message.*

For full information on supported devices, versions and step by step software installation procedures, please refer to the **AJA Desktop macOS Installation guide**, available at the following location:

<https://www.aja.com/support/item/10171>

Release notes for AJA Desktop Software packages will always include the latest information on compatibility with macOS versions and Apple hardware.

## Mac, Windows and Linux Packages

---

These packages include:

### Drivers

---

AJA device drivers for tightly integrated hardware/software operation.

### AJA Control Panel

---

The Control Panel provides:

- Source selection and control of your AJA hardware
- A block diagram to show visually what routing and processing is being performed

NOTE: See "[AJA Control Panel](#)" on page 20.

### AJA Control Room

---

Control Room is a cross-platform software application for ingest, playback and output with AJA devices.

NOTE: See "[AJA Control Room](#)" on page 56.

### AJA System Test

---

System Test provides accurate and detailed evaluations of drive and system performance statistics, allowing you to measure the capabilities of your system for recording and playing back various resolutions and codecs. The application includes:

- System Disk Test
- AJA Device Test
- System Report

The application tests Read and Write, Capture and Playback speeds in both Megabytes per second and Frames per second. The disk speed tests differ from standard disk I/O performance applications in that they specifically test the system under conditions typically encountered with video capture, playback, and editing.

NOTE: *One way to test storage performance is to fill the target disk to 80% and then test capture at the highest data rate you will use. This may not be practical in all use cases.*

## Additional with Mac and Windows Packages

---

### AJA Plugins for 3rd-Party Applications

---

AJA provides plugins for popular 3rd-party Professional Video Applications from Adobe, Avid, Apple, OBS, and Telestream. This allows these applications to communicate with AJA hardware products and control their operation and parameters. These AJA plug-ins are automatically installed when you run the AJA Software Installer, for each and all of the third party applications previously installed on that computer.

*NOTE: See <https://www.aja.com/compatibility/kona> for KONA X and KONA family third party software compatibility.*

## System Requirements

---

*NOTE: On macOS, the KONA X supports Apple silicon processors as well as earlier Intel processors.*

*NOTE: Installing the software requires adjustment to system security. See "[macOS Installations](#)" on page 16.*

AJA Video recommends that your system meet minimum hardware and software requirements to achieve a satisfactory level of performance. Updates to system requirements are subject to change.

See the Release Notes for you AJA Card or Device, available on the AJA website and also installed with the software package, for minimum and recommended system requirements including OS, CPU, RAM, and GPU.

*NOTE: Also see [Software Vendor system requirements for GPU recommendations and additional hardware requirements and recommendations](#).*

*NOTE: For large scale installations with shared storage, IP, or for very high performance requirements, AJA recommends consultation with an experienced system integrator. A consultant will be able to assist with many important variables.*

## Disk Storage Methods

---

To ensure performance and quality, the disk storage system used with the workstation must be able to meet the demands of storing real-time uncompressed media. At the very minimum, the disk storage system must be able to provide and maintain a consistent transfer rate from the workstation to disk (read/write). There are a variety of system configurations and peripherals that can provide this level of performance.

For more on disk storage performance see "[AJA System Test](#)" on page 9.

# Chapter 2 – Installation

---

## Installation Overview

---

The installation and set up of a KONA card is simple, and may vary slightly depending on your system.

For the most up-to-date Windows and Mac system requirements for KONA, see the following on the AJA website:

<https://www.aja.com/page/system-configuration/>

*NOTE: AJA KONA X cards can also be used in an external Thunderbolt chassis, for when using host systems without PCIe slots.*

## Third Party Software Support

---

For further support information regarding third party software compatibility, see:

<https://www.aja.com/compatibility/kona>

## Unpacking

---

As you unpack your shipment, carefully examine the contents. Ensure you received everything and that nothing was damaged during shipping. If you find any damage, immediately notify the shipping service and supply them with a complete description of the damage. AJA will repair or replace damaged items. If you find shipping damage, contact your AJA dealer or distributor for details on how to have your KONA X card repaired or replaced.

*NOTE: Save packing materials and the shipping box. If you ever require service or move your system use the packaging materials and box for safe shipment.*

## Shipping Box Contents

---

Your KONA X shipment will include:

- KONA X PCI-Express card

Your shipment may also include:

- KONA Xpand PCI Express breakout card (if ordered together)
- AES and GPIO\* ribbon cable (included with KONA Xpand card)
- MULTI IO breakout cable harness\*\* (included with KONA Xpand card)
- Mini-BNC-to-mini-BNC ref cable (included with KONA Xpand card)
- LTC In/Out Cables (included with KONA Xpand card)
- RS-422 Ribbon cable (included with KONA Xpand card)

*NOTE: \*GPIO contacts on the AES-GPIO ribbon cable require a custom breakout cable. Contact AJA Support for information.*

*NOTE: \*\* The KONA Xpand MULTI IO breakout cable harness can also be used with AJA KONA 5 cards.*

# Installing the KONA X Card

---

Figure 2. KONA X Card



The KONA card can be installed into a PC chassis, Mac Pro chassis with PCIe slots, or into a Thunderbolt 3 or 4 PCIe external chassis.

**IMPORTANT:** The KONA X card requires ATX power. For customers who wish to use a Thunderbolt 3 or 4 expansion chassis, the chassis must provide ATX connectivity and adequate power.

**IMPORTANT:** If both a KONA X and KONA Xpand card are installed in an external chassis, make sure the power supply is sufficiently rated.

1. Uninstall previous version of AJA Desktop software (if any) for AJA KONA, AJA Io or AJA T-TAP from the host machine where your KONA X card will be installed and connected. If prompted, restart the computer.
2. Shut Down the computer if it is on.
3. Turn off power\* to the host chassis.

**NOTE:** \*Usually not needed. Only needed if the host chassis has a main AC power switch that a system shutdown does not turn off.

4. Touch the outside of the chassis to discharge any body static.
5. Remove the AC power cable from the back of the chassis.
6. Open the chassis.
7. Locate a recommended PCIe slot (see "[Installation Overview](#)" on page 11 for more information).

**IMPORTANT:** If a RAID controller is present, always put it and KONA X card on separate PCIe buses. This improves performance by reducing bus contention.

8. Remove the blank backplate from the chosen PCIe slot, if one was there.
9. Touch the chassis to discharge any body static.
10. Remove the KONA X card from its anti-static shipping bag.
11. Carefully insert the card by rocking it slowly into the slot. Ensure the card aligns properly with the slot opening and is fully seated.
12. Connect an ATX power cable from the host motherboard or chassis power supply (depending on the particular chassis) to the rear of the KONA X card.

**NOTE:** Different PC hardware configurations can result in the text on the installed card bracket being upside down.

Figure 3. KONA X, ATX Power connection

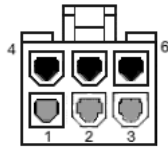
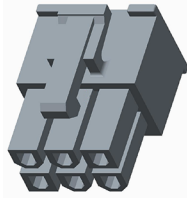
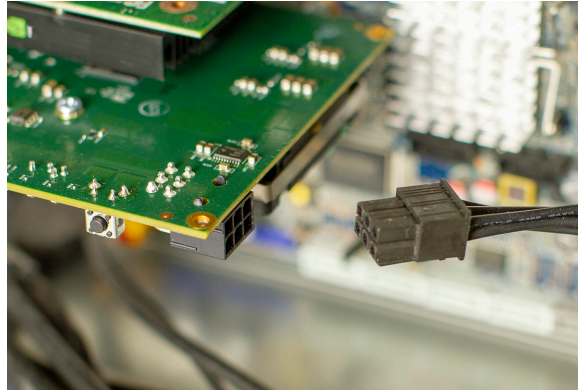

PC Internal ATX  
Power Connector  
1, 2, 3 = +12v  
4, 5, 6 = COM  
(Molex p/n 45559-0002)

13. Secure the card in the chassis such as by a backplates lock bar, or by using a screw through the backplate into the chassis.
14. Close the chassis.
15. Reconnect the AC Power cable to the chassis.
16. If you are also installing a KONA Xpand card, please follow that procedure next.

*NOTE:* See "[KONA Xpand Installation](#)" on page 62.

17. Power up the chassis.
18. Proceed to install the latest software.

*NOTE:* See "[Installing KONA X Software](#)" on page 16.

# Cabling the System

## KONA X Example Cable Connections

Figure 4. Typical KONA X system connections

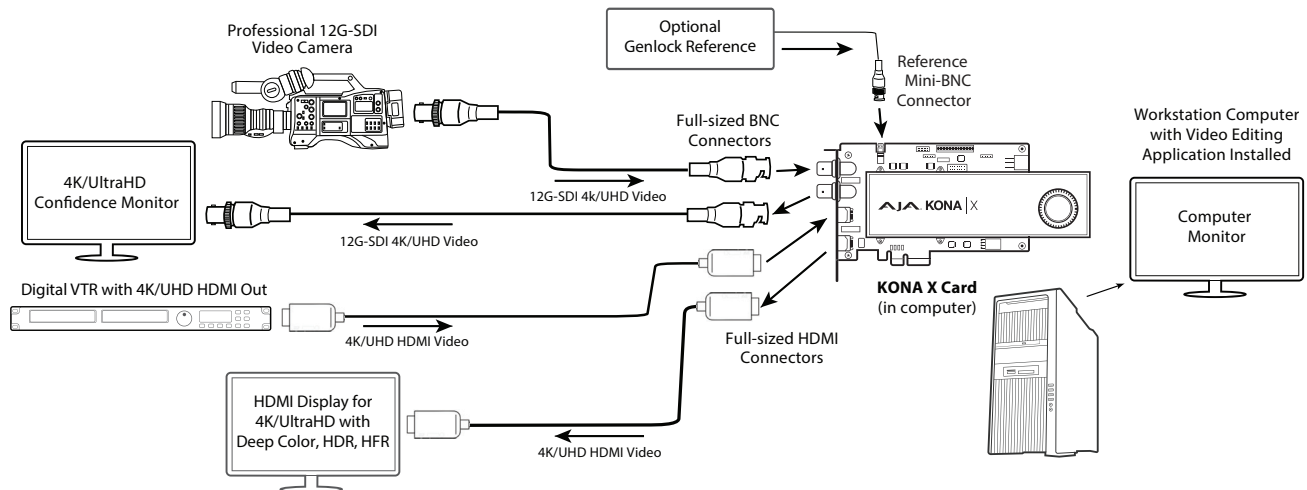

In the KONA X system example above, a single link 12G-SDI camera signal and/or a digital VTR with an HDMI 2.x output is received by the KONA X card, and is sent to a Deep Color Display Monitor.

**NOTE:** The following connections are for the particular example shown above. Numerous other workflows are possible including a wide variety of equipment not shown here.

1. If desired, connect your house reference sync to the KONA X Reference connector located on the top edge of the KONA X PCIe card.

**NOTE:** The KONA X card includes a mini-BNC reference connector for use with an appropriate user-supplied cable, and in lieu of the optional KONA Xpand card.

2. Connect an HDMI monitor to the KONA X card's HDMI output connector.
3. Connect the KONA X's SDI 2 BNC to the SDI output of the 12G-SDI video camera.
4. Connect the KONA X's SDI 1 BNC to the input an HD SDI digital Confidence Monitor.
5. Eight channels of embedded audio are supported, so the Digital VTR must be configured accordingly.

## KONA X Audio Monitoring

Supported KONA X hardware can be used as your single audio monitoring solution whether you are auditioning music in a web browser, playing a movie file on the desktop, creating music, or playing a YouTube clip. As long as the output of your work or application is normally output via the host system audio, your AJA hardware can route this audio for monitoring. This cuts down on unnecessary cabling, and means you can take advantage of a consistent audio monitoring environment whatever you are currently doing with your host system.

**NOTE:** On first use, you will need to tell your operating system to use AJA hardware as the default Input and Output hardware.

KONA X lets you listen to Host System audio concurrently with your NLE audio. This is useful if you need to audition music tracks against playback of your NLE timeline, or if you need to communicate using VOIP (Zoom, Teams, etc.) with a remote producer during an edit session, or for a myriad of other reasons.

You can also listen to KONA X Input concurrently with your NLE. This is useful if you need to listen out for the readiness of talent, or the presence of some other feed, whilst you continue to work.

KONA X audio monitoring is routed and mixed using the Control Panel application's Audio Mixer screen.

**NOTE:** See "Audio Mixer Screens" on page 41.

You can select sources to be monitored, and can adjust their levels.

The mixed audio monitor signal is also routed to:

- SDI Audio out
- HDMI Audio Out
- Analog Audio Out (via analog breakout cable and optional KONA Xpand card)
- AES Audio Out (via digital breakout cable and optional KONA Xpand card)

**IMPORTANT:** Even though you can hear changes in the signals and levels adjusted with the Audio Mixer screen, these changes are NOT recorded to disk during NLE Capture or Audio Punch In / Voice Over to Timeline. The Audio Mixer screen is dedicated for monitoring only, not program mixing.

Figure 5. KONA X Audio Monitoring routing diagram

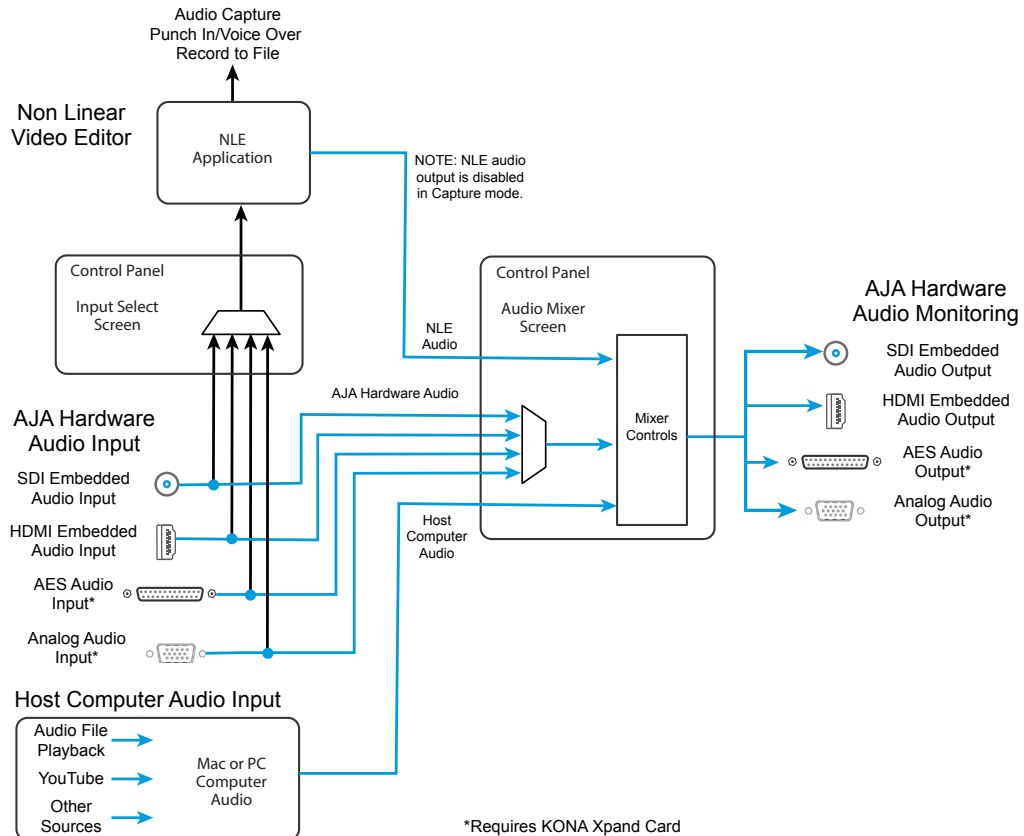

To control which AJA hardware audio is used during recording, you use the Control Panel application's Input Select Screen, Audio Input Select drop down to select from

- SDI embedded
- HDMI embedded
- AES (via Micro IO breakout cable on the optional KONA Xpand card)
- Analog audio (via XLR breakout cable on the optional KONA Xpand card)

Any level adjustments to Capture or Audio Punch In / Voice Over to Timeline recording operations will either need to be made upstream of the AJA input, or else via adjustments within the main NLE application (e.g. via a pass through mix tool).

## Installing KONA X Software

---

*NOTE: If the AJA SDK is installed, uninstall it before proceeding below.*

### Download

---

Go to the AJA website and download the latest AJA Software Installer package containing the AJA Control Panel and Control Room applications:

<https://www.aja.com/support/>

System software updates may occasionally become available to AJA KONA X owners on our website. We recommend checking occasionally for both software updates and additional product information.

*NOTE: See <https://www.aja.com/products/kona-x#support>*

*NOTE: If your computer has previously had another video capture or multimedia device installed, ensure you uninstall any related software before installing KONA X This will prevent any hardware or software conflicts.*

### Software Package Installation and Re-installation

---

Before installing the KONA X software package, ensure that your capture/editing application is installed as detailed in its user documentation. You cannot use KONA X with a third party application until the application has been installed and run at least once on your workstation. Next, install the AJA Software package.

If you add KONA X supported applications at a later date and have not previously installed the appropriate drivers, you must run the install program again selecting the appropriate application support software to be installed.

### macOS Installations

---

The products covered in this manual are compatible with Apple systems running macOS versions spanning several generations.

Note that different macOS versions will present specific dialogs during the installation process depending on the version and the specific model of device the AJA Desktop drivers and tools are being installed onto.

For full information on supported devices, versions and install procedures, please refer to the AJA Desktop macOS Installation guide, available at the following location:

<https://www.aja.com/support/item/10171>

Release notes for AJA Desktop Software packages will always include the latest information on compatibility with macOS versions and Apple hardware.

# Firmware Update Procedure

After the AJA Software package has been installed on a computer with your AJA hardware installed, the firmware on that AJA device can be updated if a newer version of firmware is included with that software package.

1. Open the AJA Control Panel application.
2. If you see the message, "Switch to the Firmware panel now?", click **OK**.

Figure 6. Switch to firmware panel dialog

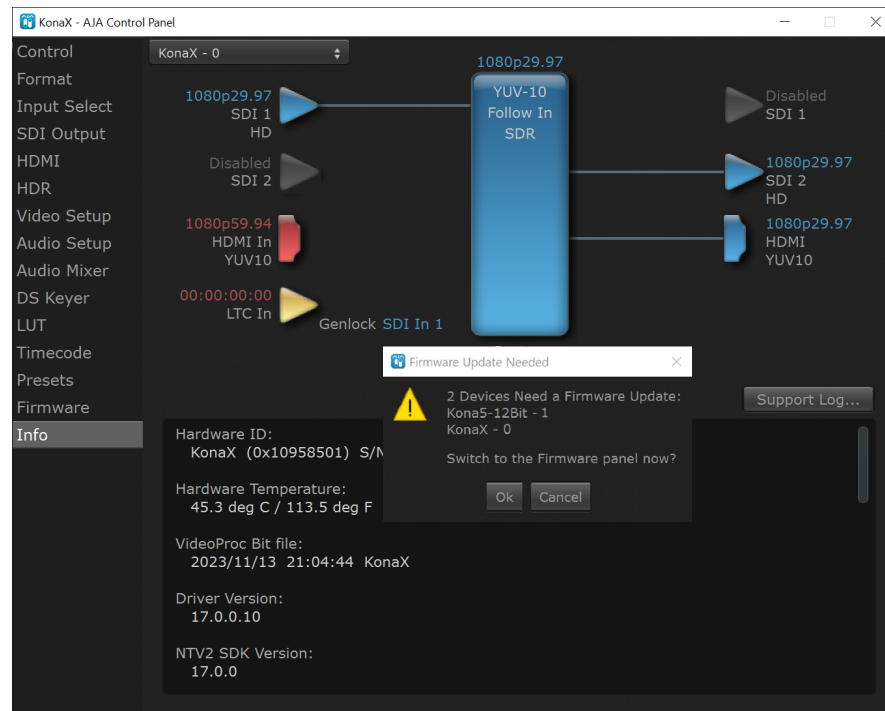

3. (Otherwise) click on the Firmware Tab in the left pane of Control Panel to open the Firmware panel.
4. If more than one AJA device is connected, choose the device you want to update by selecting its name from the drop-down menu at the top of the screen.
5. Select the newest firmware version (if multiple versions exist) in the **Desired** dropdown menu.
6. Click the **Install** button.

Figure 7. Confirm installation

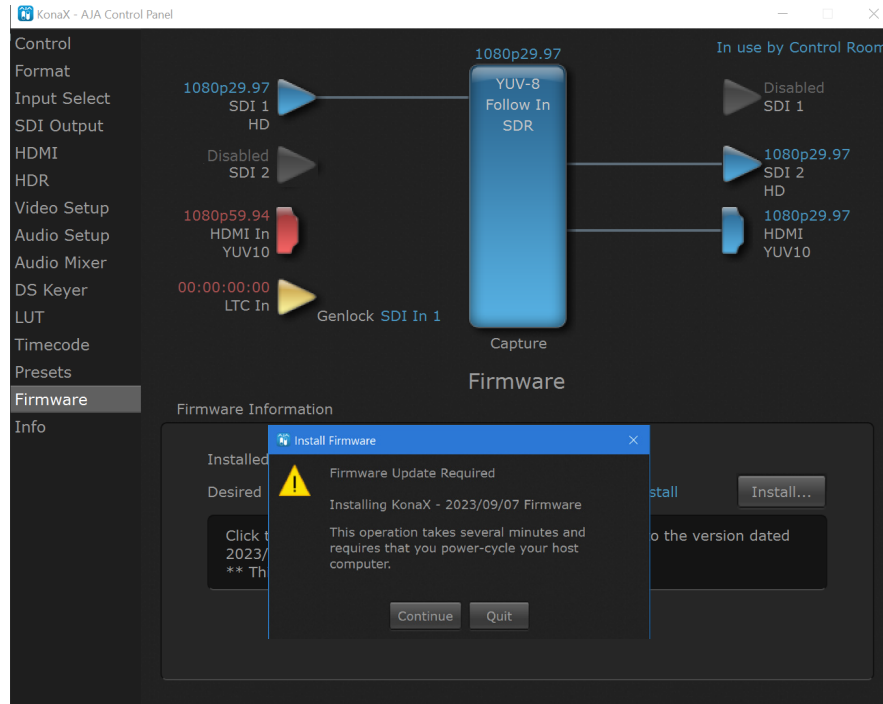

7. In the Caution dialog, click **Continue**.
8. You will notice **Erasing...** and **Programming...** progress bars. Wait until these have completed.

Figure 8. Erasing progress bar

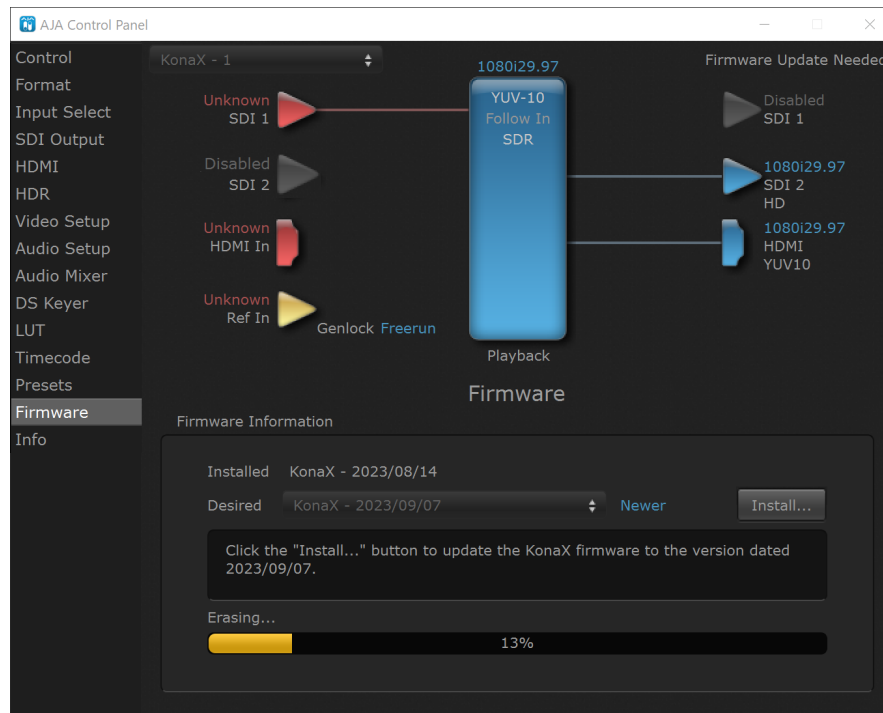

9. After firmware has been updated, a shut down/power cycle dialog appears.

Figure 9. Initiate a Power Cycle after a successful firmware update

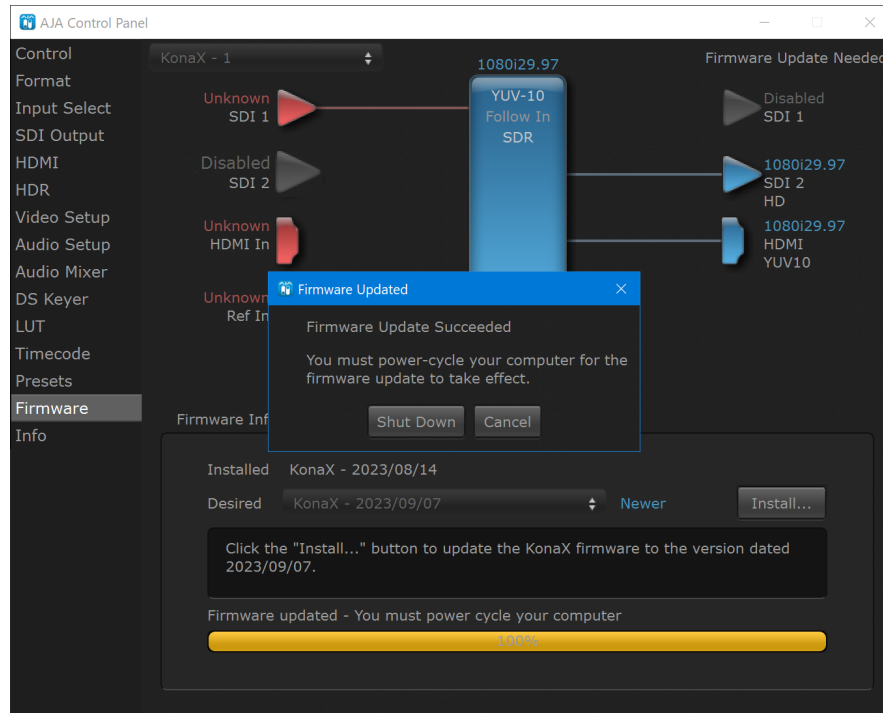

10. Click **Shut Down** to power down the computer.
11. Power on the computer.
12. Open AJA Control Panel. The AJA hardware with the updated firmware should be recognized by the Control Panel application.

# Chapter 3 – Operation

---

## AJA Control Panel

---

The AJA Control Panel is a software application that provides a simple visual showing how the KONA hardware is currently configured and allows you to make changes. You can change signal input and output parameters and define the video processing that will be performed.

The AJA Software Installer package automatically installs the Control Panel application on your computer.

*NOTE: See "Installing KONA X Software" on page 16.*

## AJA Control Panel Operating Modes

---

AJA Control Panel has two fundamental operating modes.

**Playback Mode** - Used for playing back video files from the computer, usually with a non-linear editing application (NLE) or AJA Control Room, through the KONA X card to that card's video/audio outputs for viewing and/or external recording.

**Capture Mode** - Used for capturing video/audio signals that are coming into the KONA X card from an external source to create video files on the computer using AJA Control Room or an NLE, or just for display on the KONA X outputs. This mode is also used for stand-alone video display or conversion when Control Panel is being used without an external controlling application.

The current KONA X operating mode is reported on the Control Panel UI screen, below the block diagram (see [Figure 10 on page 21](#)).

## AJA Control Panel User Interface

---

The AJA Control Panel user interface includes a visual block diagram of the unit's current configuration. The current status, input and output settings, and many other details are depicted in the color-coded block diagram. Below this block diagram are various controls for changing operating parameters, which will vary depending on which function screen\* has been selected.

*NOTE: AJA devices can automatically adjust settings for specific signal inputs, outputs, and processing. This information is reported on the AJA Control Panel's block diagram. One example is if outputting 4K, HFR, YCbCr 4:2:2 10-bit from the framebuffer, if the HDMI transmitter is version 1.4b the video is automatically adjusted to 4:2:0 8-bit.*

*NOTE: \*Function screens are also sometimes referred to as 'Tabs' or 'Panels'.*

The left side of the AJA Control Panel provides a navigation list (tabs) of available function screens. Clicking on a link (or alternatively, a related element in the block diagram) displays a function screen corresponding to that topic.

Figure 10. AJA Control Panel Info Tab, showing block diagram and controls

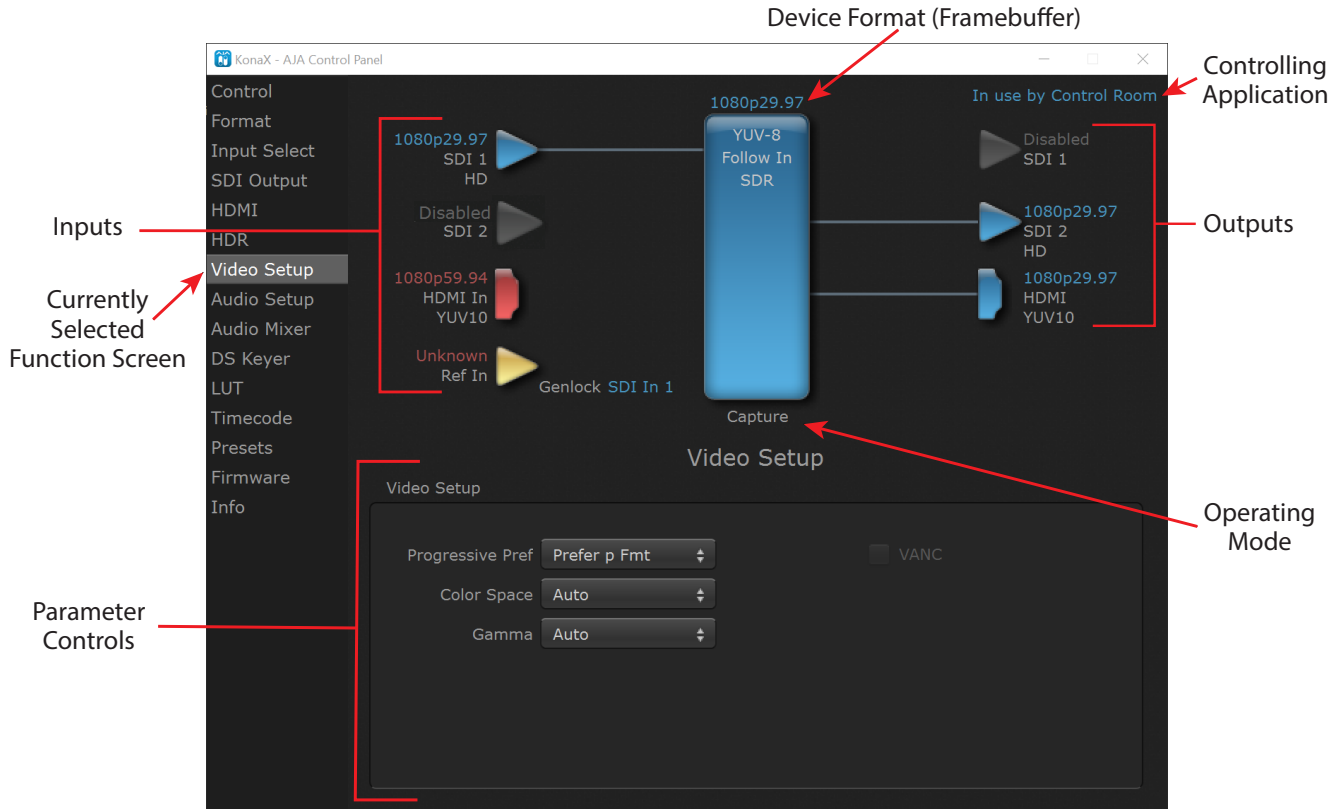

Some controlling applications can switch the card's mode from Playback to Capture, and vice-versa. When Control Panel is not being controlled by an external application, you can change the operating mode in the Control Panel Control Screen using the Default Output settings.

- Selecting Passthrough (Cap) sets the card to Capture Mode
- Selecting either Test Pattern (PB) or Hold Last App sets the card to Playback Mode

See "[Default State](#)" on page 27 for more information

## Block Diagram Area

The top block diagram area of the Control Panel screen is a visual representation of the processing, if any, that's currently occurring, including inputs/outputs, reference source, and system status. Lines between inputs, the framebuffer, and outputs, show a video path. Where there are no lines, there is no connection; this can be because an input or output isn't selected in the Input Select menu. The lines will also show whether the outputs are video or video + key.

**NOTE:** If a KONA X card's SDI output BNC is available, that card's output signal will be routed to that extra BNC, providing two identical SDI output signals.-

You can click any of the function screen selection links ('tabs') in the left column to view its current settings. Or click on an icon in the block diagram to call up its related settings screen. You can also right-click or Control-click to see context-sensitive information and choices.

Figure 11. Context sensitive menu

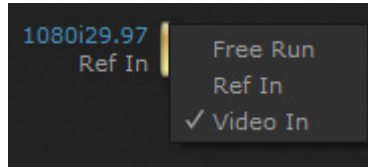

## Color Meanings

---

All items in the AJA Control Panel block diagram are color-coded to show what is happening in real time. This applies to both icons and text. These colors indicate:

### Blue

---

Video is same format as the Device Format (framebuffer).

### Green

---

Indicates that KONA is performing an active change to the video making it different from the Device Format (e.g., down-conversion).

### Red

---

The selected operation cannot be performed. This can be due to either a cable not connected, a signal not recognized, or a function not relevant to the current operating mode (capture vs. playback).

### Yellow

---

Reference video (black burst or other reference source).

## Input/Output Icons

---

The input and output icons are triangles that together with their color show all the input and outputs and their status (selected, not selected, input present or not, format, etc.). A complete video path is shown when inputs and outputs are connected with lines going to/from the framebuffer.

Figure 12. Input/Output icons



**NOTE:** *Hovering your cursor over an Input or Output icon opens a tooltip that reports that connector's signal status (Input signal detected, Output signal enabled, Input or Output disabled).*

## Framebuffer

---

The framebuffer is the “engine” where your third party applications interface with the AJA device. The framebuffer has a format (called the “Device Format”) and color space that it follows, as defined in the linked menu screens or via external application software.

## Device Format

---

The Device Format is the media format written to disk and used in your project. This is the format that the framebuffer will use and is shown in the Control Panel using the color blue. It is the format that the third party application software will either receive from the AJA hardware, or is sending to the hardware. All icons in blue are the same as the Device Format used by the framebuffer. Also any text descriptions in the block diagram that appear in blue indicate that something is in the Device Format. For example:

- If the input and output icons are blue, you know that the same format is used throughout the video path. No format conversion is being performed.
- If the input or output icon colors differ (blue input and green output icons for example), you know that a format conversion is being performed.

## Converted Format

---

*NOTE: A Converted Format is not available on a KONA X card.*

Any format other than the currently selected Device Format is a Converted Format. As described previously, this means that either the Inputs or Outputs are somehow different from the framebuffer's assigned format—the Device Format. A conversion is readily apparent because of the color change from blue.

In some cases the application you use with the KONA will automatically set the Device Format, overriding the user's selected Device Format in the AJA Control Panel.

## Controlling Application

---

It is important to understand that your computer may contain many applications that can use the AJA device (as you switch from window to window) and it may not always be obvious which currently controls it. In the top right corner, the Control Panel displays the name of the application controlling the unit.

*Figure 13. Control Panel in use by external application message*

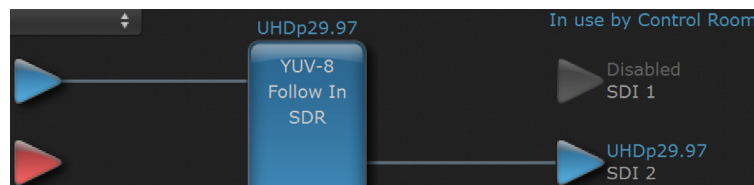

KONA X is very flexible and most controlling applications perform the necessary housekeeping so they work correctly when they're active and when they're not. This means that the application that is "active" (in front) will be granted control of the KONA X video output. Generally, when you switch to a different application, the previous application lets go of the video output and the new application gets control.

In some cases, however, applications may not always properly "let go" of the I/O interface as another takes over. If this occurs you'll be able to tell by looking at the Control Panel's in use application name.

## Controlling Application Format Selection

---

If a running controlling application uses KONA X for capture or output, it controls the Device Format via its own menus and settings. For example, when the Third party editing application is active (it's the front-most application) and has KONA X as its "A/V Device", the KONA X's Device Format is determined by the application's "Video Playback" settings. These format selections are reported in the AJA Control Panel block diagram.

Controlling applications can start and stop and change modes—even while they are running. And the behavior of different controlling applications can vary: some applications take control of the interface as soon as they are launched and don't give it up until they quit, while other applications take control of the interface only when they are the “front-most” running application and then relinquish control when they're not. Even these controlling applications may not relinquish control until capture or output operations are completed.

## AJA Control Panel Restart Services

---

AJA Control Panel Restart Services allows for restarting the AJA services if necessary. This can help if various applications begin contesting for access to the Video I/O device. In this situation an **AJA Agent is not running** message can appear as the controlling application status. Hovering your cursor over that message displays a **Restart Agent** button, which clicking on will bring Control Panel back to its startup state. Then an application can freshly acquire control of the I/O device. Currently this feature is only available for macOS installations.

*Figure 14. Restart Services popup message*

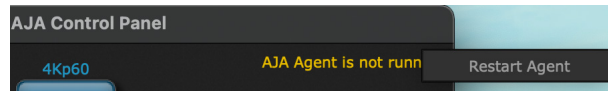

## Control Recommendations

---

We recommend you have the Control Panel running and visible at all times. When the Control Panel is running in the background (not front-most) you cannot see what the interface is doing and who has control of it.

## Presets

---

Control Panel Setups can be named and saved as a snapshot (Preset) for recall at any time. You can save various Control Panel configurations associated with your frequent tasks. You don't have to spend time resetting interface configurations—just load the previously saved Preset for each task. If you work on multiple systems and want to carry your saved setup to another location, you can copy your saved Presets file on to movable storage and load it into any computer running the AJA Control Panel application. Presets are described in more detail later in this manual.

## Single-User & Shared Preferences

---

When an AJA device starts up, preferences can determine what settings it will have it when it begins to operate. The AJA Control Panel offers preference settings that support both:

- User Preferences— Preferences stored from the last Control Panel State to be used on next startup of AJA Control Panel
- Shared Preferences— Preferences saved by an Administrator for use as a default start state for AJA Control Panel

## User Preferences

---

This file exists to immediately, automatically, store preference changes made by a user on a particular AJA device. When any control is changed in the Control Panel, that change is recorded in the preferences file stored in a unique user preferences location dedicated to that particular device and serial number. Then, when AJA control panel is restarted for any reason, it will restart with the same preferences it used when it closed.

However, if a user sets their preferences, and then replaces the AJA device with a different one, the Control Panel will either:

- Start up with the factory defaults, or
- Start up with the “house defaults” dictated by the system administrator (if a Shared Preferences file exists)

The User Preferences file can be found in the following locations.

On Mac:

---

/Users/<USER\_NAME>/Library/Preferences/com.aja.devicesettings

On Windows:

---

C:\Users\<USER\_NAME>\AppData\Local\Aja\com.aja.devicesettings

## Shared Preferences

---

An administrator can establish house standards for the AJA Control Panel by creating the user preferences file (described above) and placing it in a shared location where it will establish a standard default startup state for all users of a given computer system. These settings preempt the initial AJA default settings.

To establish the House Default for every user on every system, a system or network administrator can move this default file to all systems on the network (manually or by pushing it out across the network). All users on the network will then open to the House Defaults when they launch the AJA control panel for the first time.

*NOTE: If the user makes changes to the control panel themselves, those changes will be saved in their user preferences, which will take priority over the house default dictated by the shared preferences file.*

The Shared Preferences file should be a file created at the User Preferences location described above, and placed by the System Administrator in the following locations.

On Mac:

---

/Users/Shared/Library/Preferences/com.aja.devicesettings

On Windows:

---

C:\Users\All Users\Aja\com.aja.devicesettings

## Function Screens

---

Listed below are the function screens for KONA X and what they are used for.

Table 1. KONA X Function Screens

Screen	Functions
Control	Configure some basic operation options and output timing.
Format	Select the framebuffer primary video format.
Input Select	View and edit input selections and audio mapping.
SDI Output	Select output format.
HDMI	Configure the HDMI output.
HDR	Configure High Dynamic Range settings for SDI and HDMI output.
Analog Out	Configure the analog audio monitor setup (KONA Xpand only).
Video Setup	Configure Video such as composite black level, progressive format and ancillary data (Closed Caption) option.
Audio Setup	Configures Audio options such as analog audio monitor level.
Audio Mixer	Select and mix audio sources for playback and capture.
DS Keyer	Setup and control the insertion of keyed video from the framebuffer or graphics files with alpha channel.
LUT	Load a lookup table (LUT) file to adjust the calibration of color for any source.
Timecode	Monitors SMPTE 12M-2 timecode and configure timecode window burn output.
Presets	Add or delete saved preset configurations (handy for quick and easy recall of different KONA settings for varied workflows).
Firmware	Install device firmware from your currently installed AJA Software package.
Info	Display status information and the firmware version number. This information is generally intended for troubleshooting/support.

## Using Multiple AJA Products

More than one AJA product can be installed and available to your host computer. Using the AJA Control Panel application, you can choose which installed product an application uses for input/output. In the upper left corner of the AJA Control Panel application, you will see a board name, such as KONA X and the pane heading will read "AJA Control Panel" if you have more than one product and the associated drivers installed (if only one product is installed, you'll see no product or drop-down and the product name will appear in the header). To "target" a specific installed product for use, click on the text in the upper left hand side of the UI and select from the list of available products that appear in the drop-down.

Figure 15. Control Panel Screen showing multiple AJA devices

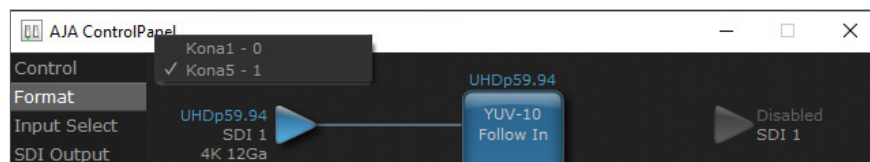

When you launch an editing application, or AJA Control Room, the application will use the product that is currently selected in the AJA Control Panel for its input/output. When an application is running, you can change the "targeted" product selection using the Control Panel drop-down menu. The running application will retain its connection to the product. If you change the "targeted" product and launch a different application, that application will use the new product for its input/output, while the first application you launched will continue to use the other AJA product.

## Notes on Using Multiple AJA Products:

Performance of multi-product use depends on a variety of factors: CPU usage, RAM, disk IOPS/ bandwidth for streams of video, etc. and therefore performance may vary. Also be aware that multiple input/output streams are only supported by software that is explicitly designed for a multi-product environment.

## General Control Panel Operation

The following Control Panel screens describe operation of the available device control parameters.

### Control Screen

Figure 16. AJA Control Panel Control Screen (Capture mode)

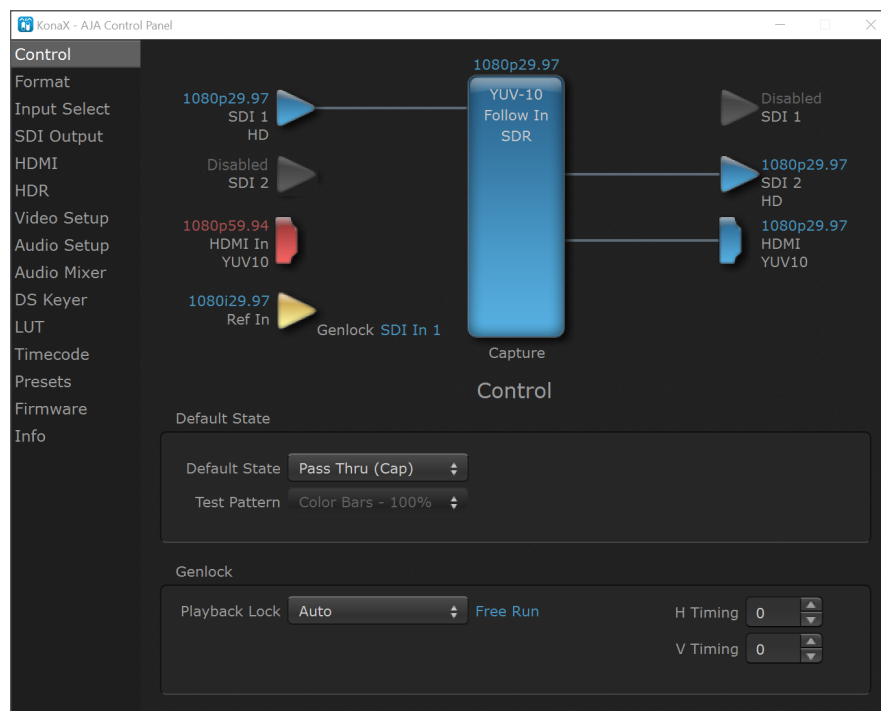

The Control Screen is where you set the Default State, which is what the device outputs when no application has control of the board. This screen also has controls for setting the genlock source, and for setting the Horiz and Vert timing offsets. The top of the Control Screen shows the current state of the device and also shows the name of the Application which has control of the board, if there is one.

### Default State

Many video applications can grab control of the KONA X, so its outputs can change dynamically. The Default State settings are used to select what state the KONA X will have when no third party video application is controlling it.

#### Default State

- **Pass Through (Cap)** - This selection directs KONA X to route video from its selected input through the card for processing and output.

- Test Pattern - This selection directs KONA X to output a preset pattern when no other application is in control. The pattern is selected from the Test Pattern dropdown list below, or a graphic file can be chosen.
- Hold Last App - This selection directs KONA X to hold and output the last frame of video from the last application to control KONA X. This can be helpful when operating in an environment where you're switching back and forth between multiple application windows.

---

### Test Pattern

With Test Pattern selected above, you can choose the pattern type. Select from:

- Black, Color bars (75% or 100%), Ramp, Multiburst, Line Sweep, Multi Pattern, or Flat Field, Check Field, White, Border, Linear Ramp, Slant Ramp, Zone Plate, Color Quadrant, Color Quad Border, or 2SI Alignment (see below).
- 2SI Alignment - This test pattern consists of one-pixel diagonal crosshairs plus a three-pixel rectangle. If there is a misalignment, the diagonal crosshairs will not be a continuous line. If it is a top-bottom misalignment, the top and bottom of the square line will be broken, with white between them. If it is a left-right misalignment, the left and right lines of the square will be fuzzy or broken. This can easily be simulated by clicking the "Quad Swap" buttons in the control panel "Video Setup" tab.

For HD and UltraHD with RGB-12 Pixel Formats the following HDR test patterns are available:

- HDR Zone Plate, HDR Linear Ramp, HDR HLG Narrow, HDR PQ Narrow, or HDR PQ Wide.

---

### Test Tone

The Test Tone control is located the Audio Configure pane of the Audio Setup screen and three choices are available:

- Off, Uniform -20db 400Hz, or Non-Uniform

### Graphic File Display

In addition to the test patterns above, a "Load File..." selection at the bottom of the Test Pattern dropdown menu allows you to load a standard RGB/RGBA graphics file (.tif,.psd, etc.) into the frame buffer for display (including alpha channel). Some graphics formats and bit depths may not be supported. Files that have been loaded are listed for quick reuse. Loaded graphic files are retained for redisplay if another test pattern is selected, and even if KONA X is power cycled.

*NOTE: A loaded graphics file will not be scaled to fit. If it's smaller than the current frame buffer format, KONA X will center it in the frame. If larger than the current frame buffer format it will be cropped.*

- Clear Files - This selection on the drop-down clears all the Graphic Display files.

---

## Genlock

Use these controls to select KONA X Genlock settings and adjust Timing.

KONA X can be configured to use a different genlock source for its Playback and Capture modes of operation. The combination of these selections affects KONA X performance when switching between Capture and Playback in Avid Media Composer (and potentially other NLEs).

## Playback Lock

Playback Mode has four Playback Lock settings:

- Auto
- Free Run: Generates sync without an external reference source
- Reference In: Uses the Ref Video source for sync (usually an analog black burst video signal)
- Video In: Uses whichever video input source has been selected in the Inputs screen for sync

## Timing (Horiz and Vert)

These two drop-downs allow output timing adjustment with reference to the Ref Video source selected.

- Horizontal: The Horizontal reference can be adjusted by selecting a number of pixels (clocks) to offset
- Vertical: The vertical reference can be adjusted by specifying a number of lines to offset.

## Format Screen

*Figure 17. AJA Control Panel Format Screen (Playback mode)*

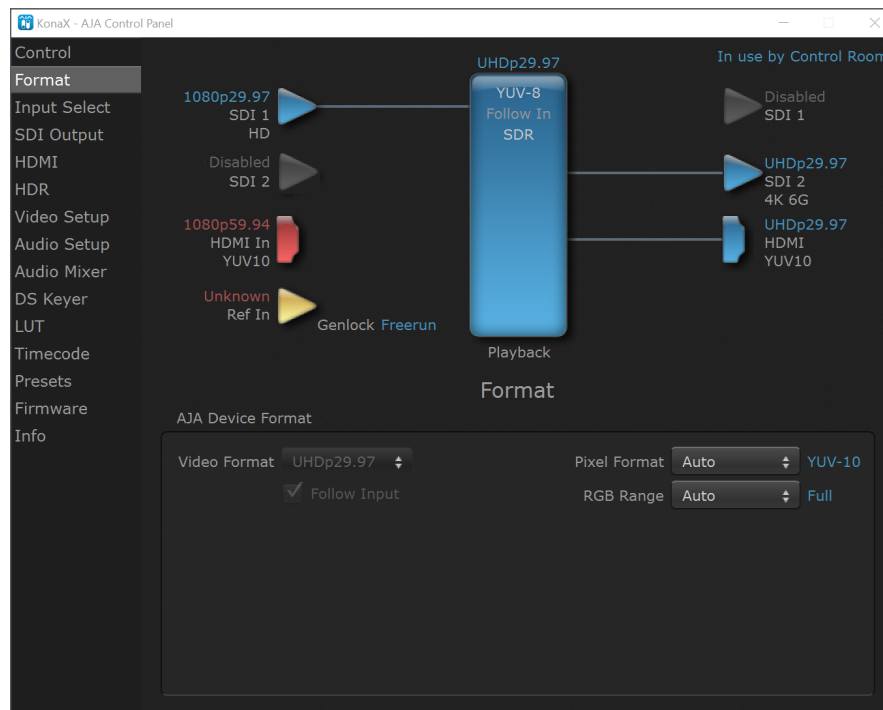

The Format Screen shows the video format currently in use by the KONA X framebuffer (called the Device Format) and allows you to change it.

## AJA Device Format

### Video Format

This drop-down menu shows the currently selected Device format, within a list of all available video formats. If you select an alternate format using the drop-down, it will change the format used by KONA X's framebuffer.

When a change is made via the Video Format drop-down or by clicking an icon and selecting a new format via a contextual menu, the block diagram will change to reflect the new format.

### Pixel Format

Use this drop-down menu to choose: YUV-8, YUV-10, ARGB-8, RGB-10 or RGB-12.

**NOTE:** KONA supports both YCbCr (also commonly called YUV) and RGB pixel formats. Because the KONA (and SMPTE SDI's) native format is YCbCr, AJA recommends using a YUV Pixel Format. YUV provides headroom for "superwhite" and "superblack", and these video levels will be clipped when transcoding to RGB. Also, RGB/YUV transcoding involves a level translation that results in mathematical round-off error.

### RGB Range

The RGB Range drop-down menu allows you to select either Auto, Full-range (0-1023) or SMPTE range (typically 64-940) for RGB color output.

**NOTE:** The AJA Control Panel software uses the abbreviation "sf" instead of "PsF" when referring to "progressive segmented frame" formats. In the manual and in other literature you may see either of these acronyms used interchangeably. Visually, it is easier to recognize:

- "sf" for progressively segmented frame formats
- "p" for progressive frame formats

### Follow Input

Enabling the Follow Input checkbox allows the Control Panel Frame Buffer to auto-switch to the detected input format. This feature works only if the controlling application supports input-based capture—AJA Control Room for example.

## Input Select Screen

Figure 18. AJA Control Panel Input Select Screen (Capture mode)

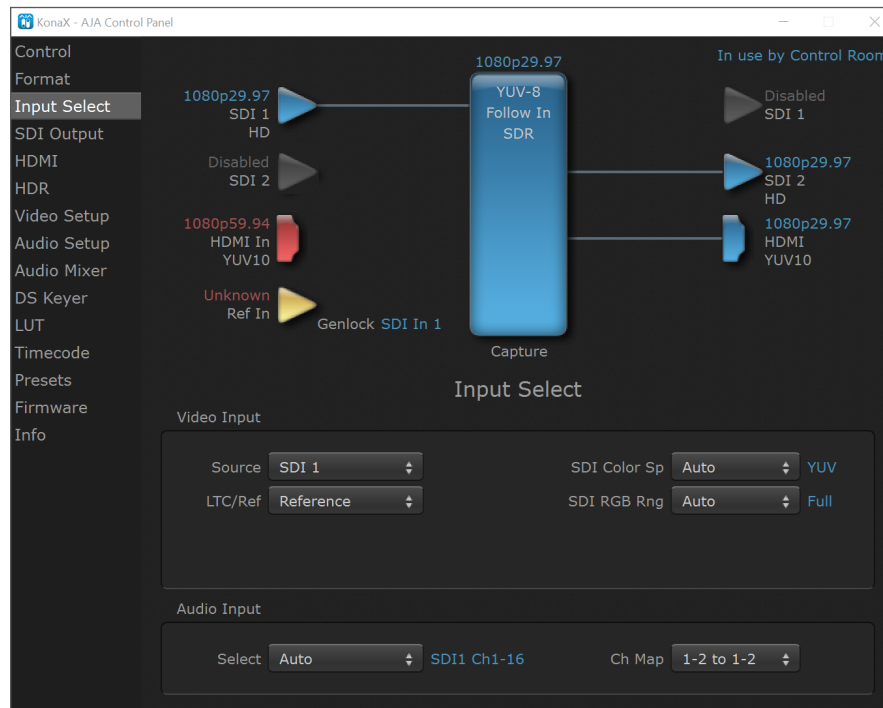

On the Input Select Screen, you can view or set the currently selected video and audio input sources and map audio sources to the channels supported by your editing application. Two information panes in the screen are provided: Video Input and Audio Input.

## Video Input

---

### Source

---

The drop-down menu allows you to select the currently selected video input source. Select from:

- Auto - Automatically selects the source depending on input format.

**NOTE:** *Automatic selection does not work with Quadrant (SQD) input signals in 4K mode.*

- SDI 1
- SDI 2
- HDMI

### SDI Color Space

---

Sets the input color space. Select from:

- Auto - Automatically selects the color space depending on input format.
- YUV - Forces a YUV input color space.
- RGB - Forces an RGB input color space.

### SDI RGB Rng

---

Sets the RGB range. Select from Auto, SMPTE, or Full.

### LCT/Ref

---

Select either Reference or LTC.

## Audio Input

---

### Select

---

The Select drop-down menu allows you to pick where the audio comes from. Different KONA cards have different audio input capabilities. Select from:

- Auto - defaults to SDI 1 Ch1-16
- SDI 1 Ch1-16
- SDI 2 Ch1-16
- HDMI
- AES/EBU (BNC)

**NOTE:** *See "Digital Cable Harness (Multi IO)" on page 59. (KONA Xpand card only.)*

- Analog Audio Ch 1,2 (XLR)

**NOTE:** *See "Analog Audio Cable Harness (Optional)" on page 60. (KONA Xpand card only.)*

## Ch Map

If only two channels were selected in the third party application you are using, you can select which two channels will be mapped to that application. Different Audio Input selections can have different channel mapping capabilities. Select from:

- 1-2 to 1-2 (default)
- 3-4 to 1-2
- 5-6 to 1-2
- 7-8 to 1-2
- 9-10 to 1-2
- 11-12 to 1-2
- 13-14 to 1-2
- 15-16 to 1-2

**NOTE:** This setting does not affect the embedded audio being sent to the KONA X's BNC or HDMI output connectors.

## SDI Output Screen

**NOTE:** If all KONA card SDI output BNC connectors are not required for the currently configured transport, the same SDI signal will be routed to both SDI output BNC connectors.

Figure 19. AJA Control Panel SDI Output Screen (Capture mode)

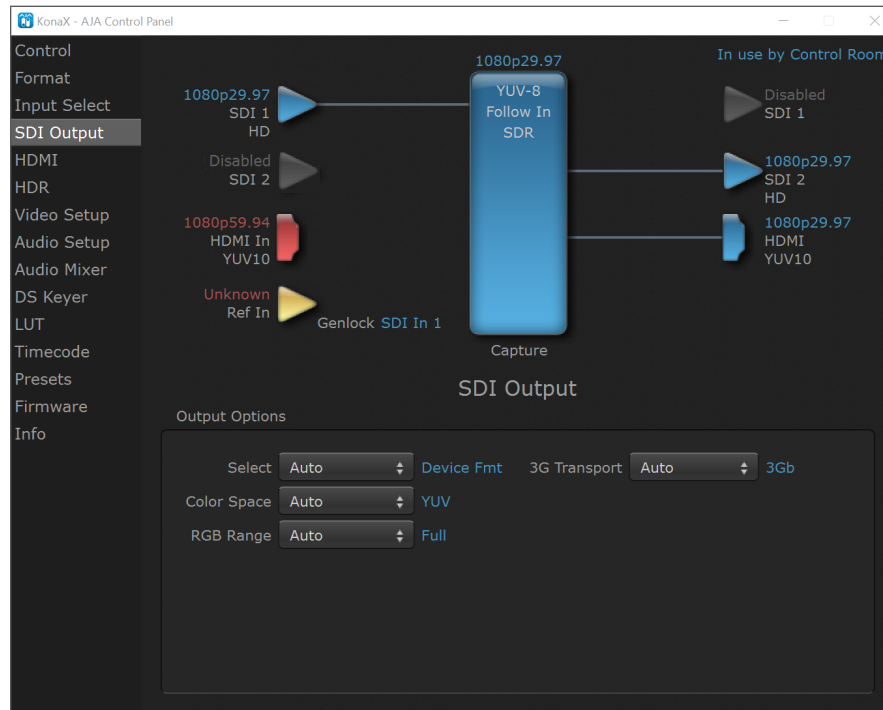

## Output Options

### Select

- Auto - Automatically selects the output format, based on the input or selected format.
- Device Format - Selects the framebuffer format for output.

## Color Space

Sets the color space. Select from Auto, YUV, or RGB.

## RGB Range

Sets the RGB range. Select from Auto, SMPTE, or Full.

## 3G Transport

Sets the output transport. Select from:

- Auto - Auto selection based on input or selected format
- 3Gb - Single link HD output using one BNC. The Level B-DS format is the dual-stream carriage of two independent HD-SDI/SMPTE 292M signals (720p up to 60 fps or 1080i/1080p up to 30 fps) in a single serial digital interface at the nominal 3 Gbit/s.
- 3Ga - Single link HD output using one BNC. The Level A format is the direct mapping of uncompressed 1080p (up to 60 fps) video into a serial digital interface at the nominal 3 Gbit/s.

Figure 20. AJA Control Panel SDI Output Screen (Playback mode)

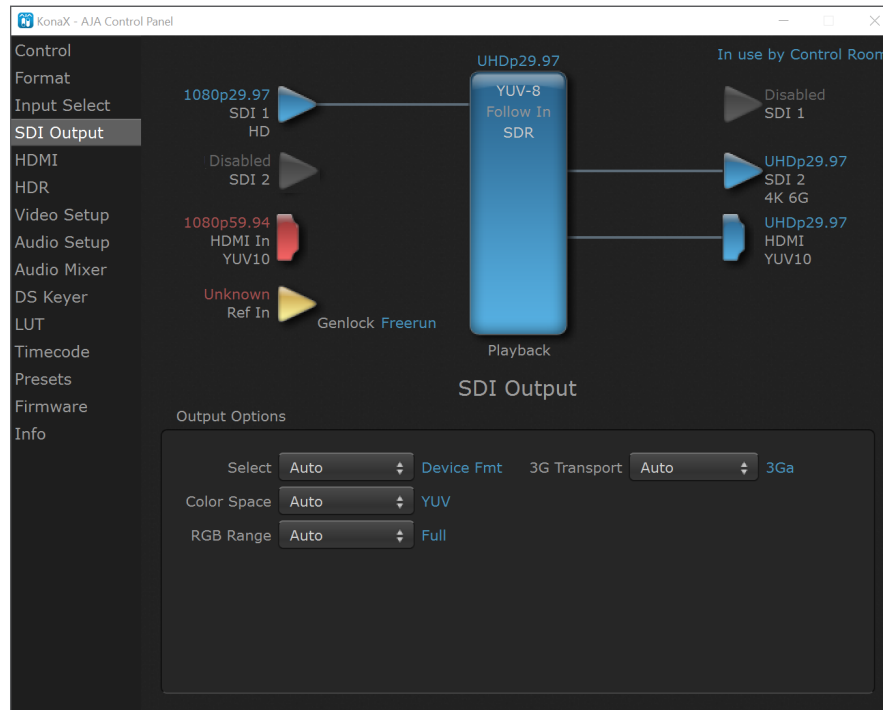

# HDMI Screen

Figure 21. AJA Control Panel HDMI Screen (Capture mode)

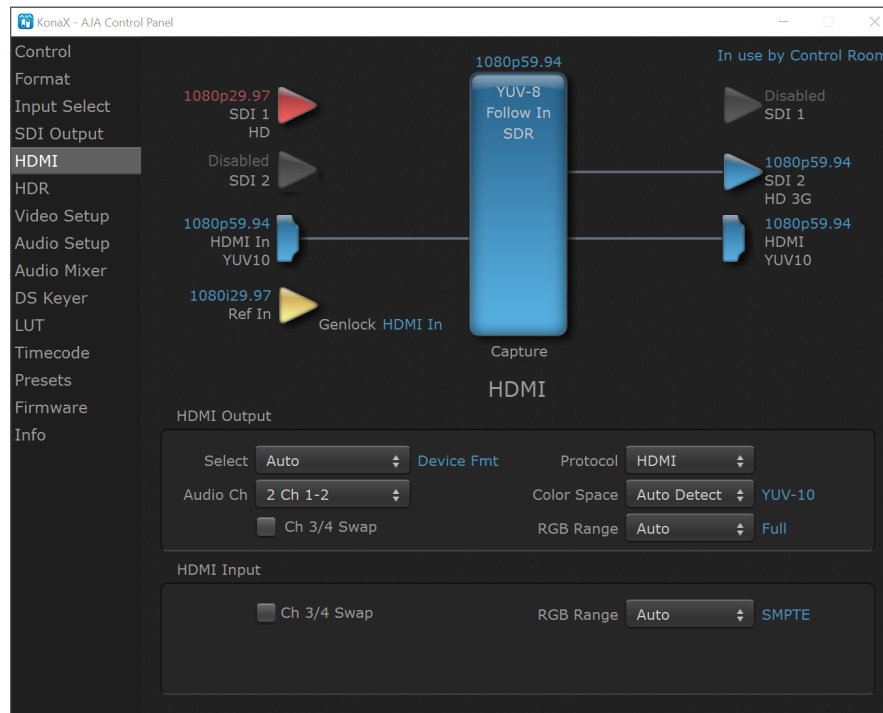

The HDMI screen is used to configure the KONA X card's HDMI Output signal.

## HDMI Output

### Select

- Auto - Automatically sets the HDMI output format, based on the input or selected format.
- Device Format - Selects the framebuffer format for output.

**NOTE:** The 4K Transport setting on the SDI Out screen also affects the KONA X HDMI output signal, even if the SDI inputs are not being used. A SMPTE 2Si setting is required for UltraHD/4K HDMI output. Other 4K Transport settings will downconvert HDMI output to HD or 2K.

### Audio Ch

This dropdown allows you to select the number of embedded audio channels for the HDMI output. Two or eight channels can be chosen. Select from:

- 2 Ch 1-2 through 15-16
- 8 Ch 1-8
- 8 Ch 9-16

### Protocol

This drop-down allows you to choose between two "Auto" modes, or to explicitly force the output to a desired protocol.

- Auto Detect – (most reliable) AJA device attempts to reconfigure the HDMI output to match the current protocol setting of the output monitor. This

option will be the most reliable in creating an output image. However, the output may result in loss of audio.

- Auto Set – (best quality) The AJA device HDMI out will attempt to automatically set the output monitor into the best protocol, usually HDMI.
- HDMI – Forces the use of the HDMI protocol regardless of the attached device's EDID. Connection may fail if output monitor does not support the HDMI protocol.
- DVI – Forces the use of the DVI protocol regardless of the attached device's EDID.

---

## Color Space

This dropdown Color Space dropdown allows you to choose between two "Auto" modes, or to explicitly force the output to a desired color space.

- Auto Detect – (most reliable) AJA device attempts to reconfigure the HDMI output to match the current color space setting of the output monitor EDID. This option will be the most reliable in creating an output image. However, the output may result in an inferior image due to color space conversion and loss of bit depth.
- Auto Set – (best quality) The AJA device will attempt to automatically set the output monitor into the best color space and bit depth that matches the user's application needs regardless of EDID of the output monitor. This may result in loss of image if the output monitor does not support a specific color space mode.
- RGBA-8 – Forces the use of RGBA-8 regardless of the attached device's EDID or user application needs.
- RGB-10 – Forces the use of RGB-10 regardless of the attached device's EDID or user application needs.
- RGB-12 – Forces the use of RGB-12 regardless of the attached device's EDID or user application needs.
- YUV-10 – Forces the use of YUV-10 regardless of the attached device's EDID or user application needs.

---

## RGB Range

The RGB Range dropdown menu allows you to select the type of RGB color output.

- Auto
- SMPTE – (typically 64-940)
- Full – (0-1023)

---

## HDMI Input

---

### Ch 3/4 Swap

- Checking this checkbox swaps audio channels 3 and 4, providing for certain applications which require that channel setup.

---

### RGB Range

- Auto
- SMPTE – (typically 64-940)
- Full – (0-1023)

# HDR Screens

Figure 22. AJA Control Panel HDR Screen (Capture mode)

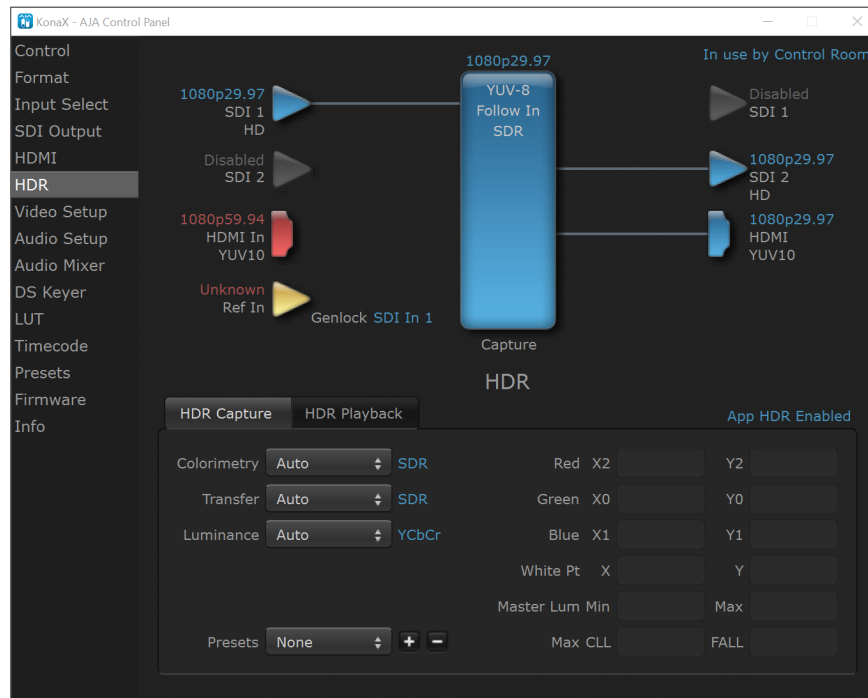

The HDR screen provides a sub tab setup for HDR playback simultaneously via both SDI and HDMI.

For SDI destinations, the HDR data is delivered in-band using VPID signaling for SDR/HDR Transfer Characteristics, Colorimetry and Luminance.

For HDMI destinations, side-band information is used to inform an HDMI sink device (such as a TV or monitor) that the video content is HDR. This includes generation of the Dynamic Range and Mastering Infoframe and the static metadata descriptors as defined in CTA-861.3 and HDMI v2.0a.

Included are preset primaries values for BT.2020 and DCI P3 color gamuts.

Two tabbed screens are available. The HDR Capture tab settings affect the HDR metadata saved with your captured video, while the HDR Playback tab settings affect what HDR metadata is included the KONA X's HDMI and SDI outputs.

KONA X supports HDR over both its SDI and HDMI outputs.

## HDR Capture Settings

### Colorimetry

- Auto - (default)
- SDR - Standard Dynamic Range
- P3 - P3 colorspace
- 2020 - BT.2020, typically used with HDR
- Custom - Allows custom values for the Digital Primaries.

### Transfer

The Electrical Optical Transfer Function metadata bit tells the HDMI display which EOTF to use.

- Auto - (default)

- SDR - Standard Dynamic Range
- PQ - Perceptual Quantization
- HLG (Hybrid Log Gamma) - No metadata for Digital Primaries.

#### Luminance

---

- Auto - (default)
- YCbCr - YCbCr color space
- ICtCp - IPT color space

## Digital Primaries

---

Selecting Custom HDR Mode allows the editing of digital primaries information that is passed as metadata accompanying the video signal. However, when HLG is selected as the EOTF digital primaries information cannot be edited, because HLG does not use metadata.

#### Red

---

- X2 value
- Y2 value

#### Green

---

- X0 value
- Y0 value

#### Blue

---

- X1 value
- Y1 value

#### White Pt.

---

- X value
- Y value

#### Master Lum

---

- Min value
- Max value

## Display Mastering Luminance ('Master Lum')

---

Represents the minimum and maximum Display Mastering Luminance.

- Minimum: Defines the floor of the SMPTE ST 2086 color volume (in the case of HDR) and is determined by the mastering environment.
  - Range: 0.0000 cd/m<sup>2</sup> to 1.0000 cd/m<sup>2</sup>.
  - Step size: 0.0002 cd/m<sup>2</sup>.
- Maximum: Defines the ceiling of the SMPTE ST 2086 color volume (in the case of HDR) and is determined by the mastering environment.
  - Range: 1 cd/m<sup>2</sup> to 65535 cd/m<sup>2</sup>.
  - Step size: 1 cd/m<sup>2</sup>.

## Maximum Content Light Level (CLL)

Represents the highest-value pixel component in an entire scene. It is determined by analyzing each frame of video, and can be determined in the post environment.

- Range: 1 cd/m<sup>2</sup> to 65535 cd/m<sup>2</sup>.
- Step size: 1 cd/m<sup>2</sup>.

## Maximum Frame Average Light Level (FALL)

Represents the maximum of frame-based average light levels taken over an entire scene, and can be determined in the post environment.

- Range: 1 cd/m<sup>2</sup> to 65535 cd/m<sup>2</sup>.
- Step size: 1 cd/m<sup>2</sup>.

## Presets

- None
- Load P3 Values
- Load Defaults
- Reset All
- Save Preset (+)
- Delete Preset (-)

## HDR Playback Settings

The HDR Playback tab settings are identical to the HDR Capture settings, but affect the KONA X's HDMI and SDI outputs.

## Video Setup Screen

Figure 23. AJA Control Panel Video Setup Screen (Playback mode)

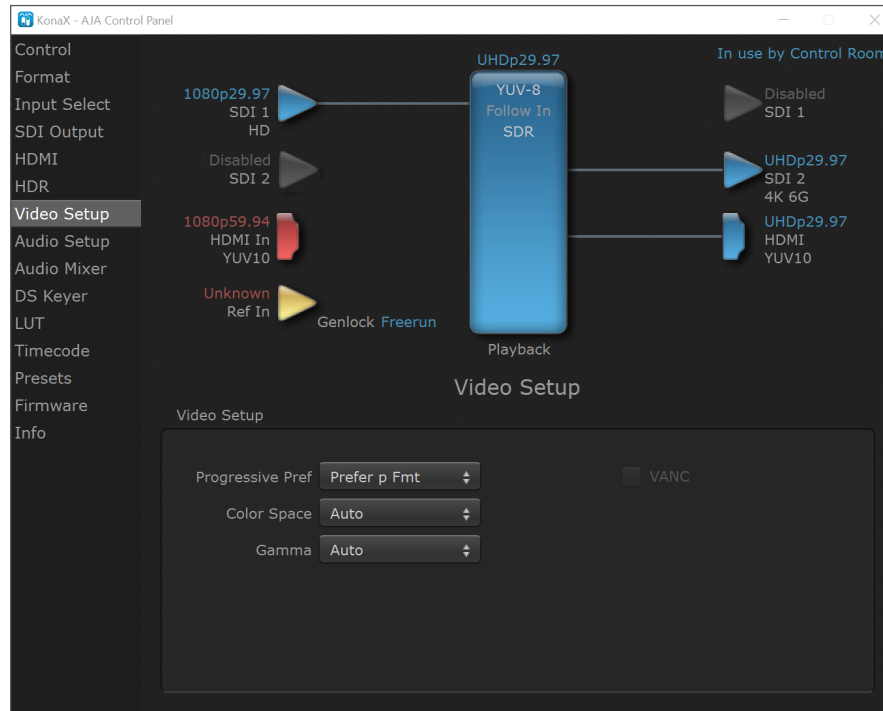

The Video Setup screen shows various other settings which will affect how video inputs and outputs behave, and how KONA interacts with some software applications.

## Video Setup

---

### Progressive Pref

---

This feature is used to default the hardware to use either p or PsF output over SDI when it has not been specified by the application. Choose between:

- Prefer p Format - progressive frames non-interlaced output
- Prefer psf Format - progressive segmented frames

*NOTE: If you change this option while your NLE (Non-Linear Editor application) is open and running, you may need to then make a change in one of your NLE settings in order for this to be reflected dynamically in the project. For example in Media Composer, simply toggling the Video Quality menu in the Timeline should cause a project format refresh to occur, thus recognizing the change you just made in Control Panel.*

### Color Space

---

Sets the video color space. Select from:

- Auto
- Rec 601
- Rec 709

### Gamma

---

Sets the video gamma. Intended for use with legacy Apple displays. Select from:

- Auto
- Gamma 1.8

### Analog Black

---

Choices available for Black Level are the two Composite analog formats. Choices presented are for US or Japan:

- 7.5 IRE (NTSC US)
- 0 IRE (NTSC Japan)

### VANC Checkbox

---

When checked ON, the VANC checkbox tells the KONA cards (previous to KONA X) to capture and process any ancillary data in the SDI stream. This can include Closed Captioning data, and other types of metadata. Applications such as Premiere Pro and Final Cut Pro will not capture or output this data through the KONA X, if this box is not checked on.

*NOTE: KONA X does not require enabling the VANC checkbox for Closed Captioning.*

## Audio Setup Screen

Figure 24. AJA Control Panel Audio Setup Screen (Capture mode)

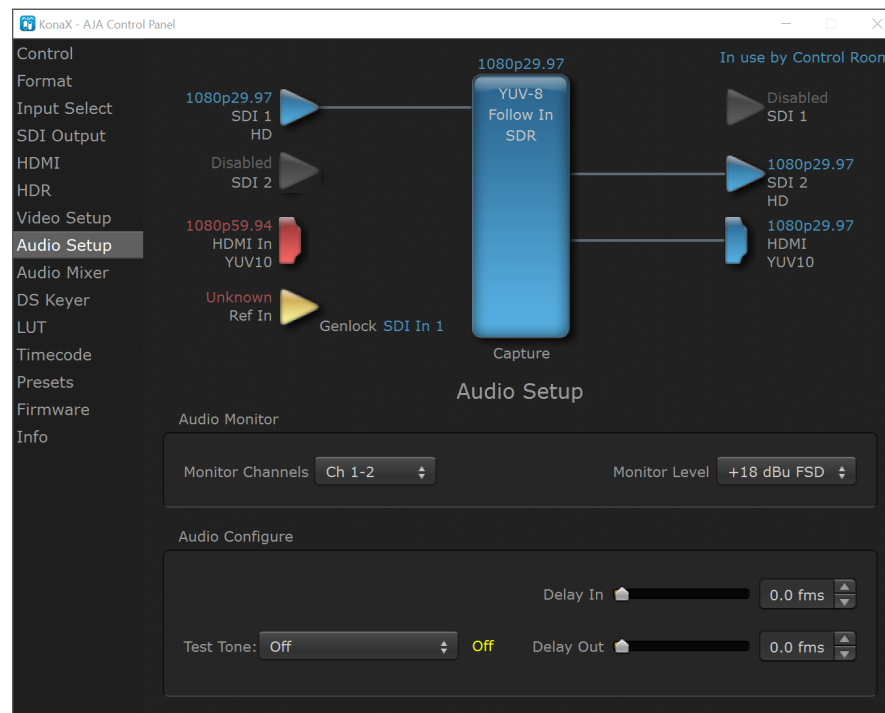

The Audio Setup Screen shows the current settings for the analog audio output, allowing you to re-configure it when desired.

## Audio Monitor

### Monitor Channels

Use the drop-down menu to select which two audio channels to monitor. Select from Ch 1-2 through Ch 15-16.

**NOTE:** This setting only applies to dual channel monitoring environments.

### Monitor Level

Allows adjustment of the analog monitor level, to match the audio to your operating levels. Select from:

- +24 dBu FSD
- +18 dBu FSD (default)
- +15 dBu FSD
- +12 dBu FSD

## Audio Configure

### Delay In/Out

Here you can set up to six frames (in tenths of a frame) of delay for KONA audio input and output. The AJA Control Panel delays all audio outputs—SDI, HDMI, and Analog.

**IMPORTANT:** If you use this Control Panel delay, do not use other delay settings in your applications. They can conflict.

## Audio Mixer Screens

The Audio Mixer screen has two tabs; Capture Monitor and Playback Monitor. These tabs display what sources are available for monitoring / mixing via the AJA hardware when in either of those two modes (if applicable). The controls on this screen are dedicated only to monitoring adjustments, and do not affect the level at which inbound audio signals are captured to storage.

The selection check boxes and screen slider controls affect the following KONA outputs:

- SDI Embedded Audio Out
- HDMI Embedded Audio Out

**IMPORTANT:** *Even though you can hear changes in the signals and levels adjusted with the Audio Mixer screen, these changes are NOT recorded to disk during NLE Capture or Audio Punch In / Voice Over to Timeline. In addition, muting or activating sources on this screen will not affect audio signals being recorded. The Audio Mixer screen is dedicated for monitoring only, not program mixing.*

The branching arrow on the lower right indicates which sources are being routed for monitoring in that operating mode, and is colored blue when active and red when disabled.

Figure 25. AJA Control Panel Audio Mixer Screen (Playback monitor)

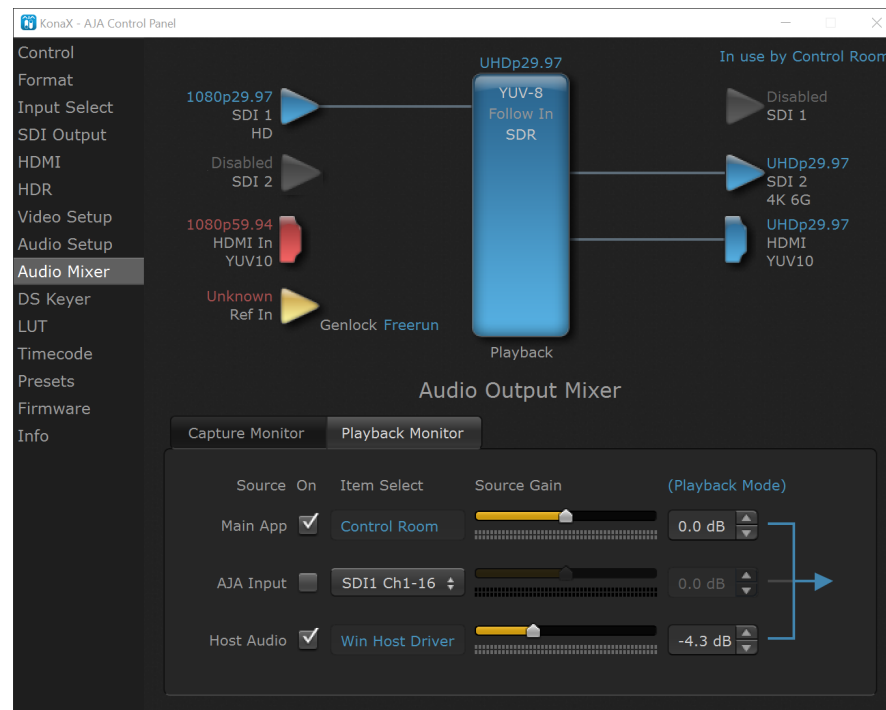

Each source has a confidence meter, which enables you to tell immediately if you have a source arriving correctly at the AJA hardware (without having to launch any other software). The level sliders allow a simple plus or minus adjustment to the Source level being monitored. This is to allow for fine-tuning of your listening environment (on occasions the host system audio can be unexpectedly loud, or an incoming feed may be very loud or very quiet).

Two different Audio Mixer screens are available, selected by clicking on the Capture Monitor or Playback Monitor tabs. During capture operations, the Capture tab is used for your monitoring experience. During regular editing, the Playback tab is used to control your monitoring experience.

Controls in each tab are only in effect when KONA is in the correct operating mode, as determined by the controlling application or the Control Panel application's Default Output setting. When the mode doesn't match, the mode indicator on the right goes red. However, settings can be adjusted while in that disabled mode, and will be applied when you return to that operating mode.

## Audio Mixer Screen Capture Monitor Tab

Figure 26. AJA Control Panel Audio Mixer Screen (Capture Monitor tab)

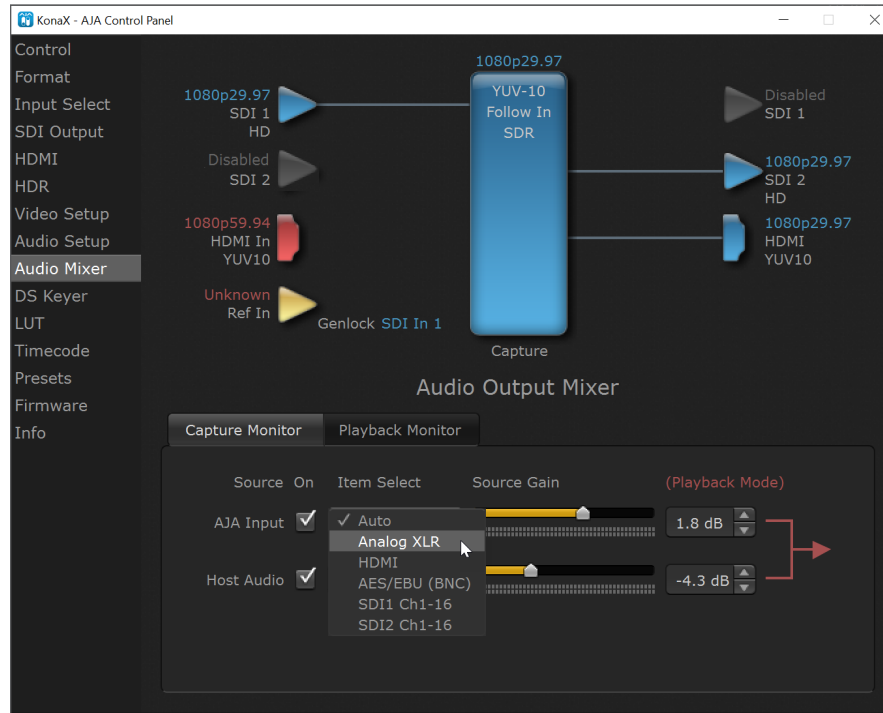

The Capture Monitor Mode screen is used to select and mix audio to be monitored during capture operations.

**IMPORTANT:** Even though you can hear changes in the signals and levels adjusted with the Audio Mixer screen, these changes are NOT recorded to disk during NLE Capture or Audio Punch In / Voice Over to Timeline. In addition, muting or activating sources on this screen will not affect audio signals being recorded. The Audio Mixer screen is dedicated for monitoring only, not program mixing.

The controls on this screen are similar to those on the Playback Monitor Mode screen, except the Main App is not available for selection (you cannot capture from the application that is capturing).

**NOTE:** If you want different behavior when the Capture tab is triggered; i.e. for host system audio to be muted, then simply check the host system audio in the Capture tab only. This way when you exit NLE Capture and return to regular editing, the Playback tab settings will be applied and your host system audio monitoring will resume.

**NOTE:** The 'Analog XLR' and 'AES/EBU (BNC)' options in the AJA Input select menu shown above, only appear when an optional KONA Xpand card has been correctly installed. See "[KONA Xpand Installation](#)" on page 62.

# Audio Mixer Screen Playback Monitor Tab

Figure 27. AJA Control Panel Audio Mixer Screen (Playback Monitor tab)

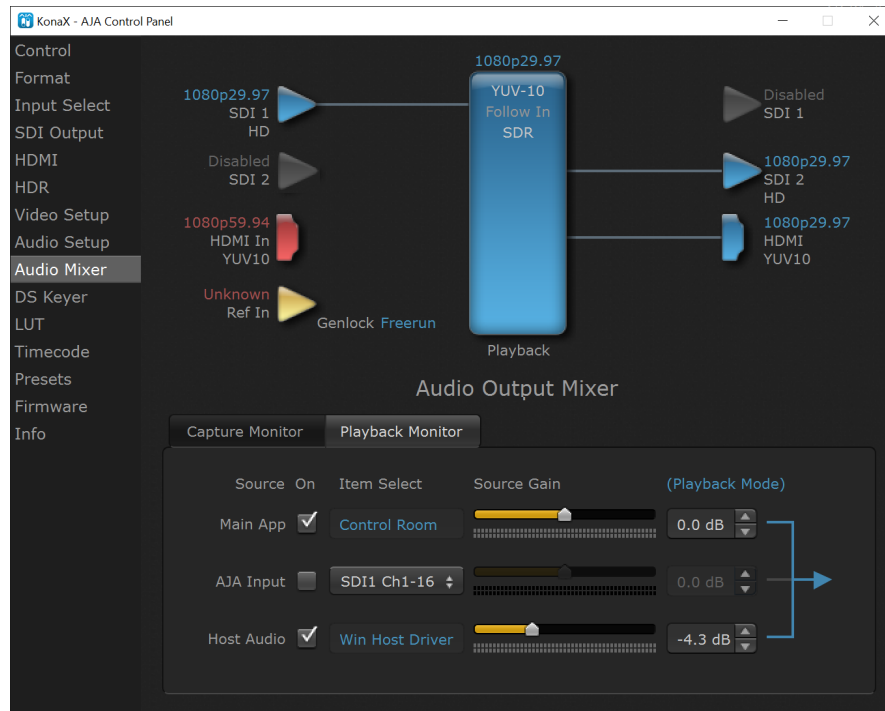

## Playback Source Selection

Clicking the On checkbox selects the audio for that item for playback to the audio monitor outputs. Multiple sources can be selected simultaneously.

### Main App

If an external application is controlling the KONA, it will be displayed in the **Item Select** column and its audio can be selected for playback with the checkbox.

### AJA Input

Selects for monitoring the audio being input to KONA.

**NOTE:** The AJA Input Item Select dropdown selection is linked to the Input Select screen's Audio Input Select dropdown. Changing the setting on one screen will also change the setting on the other screen.

In the **Item Select** column, click on the AJA Input dropdown menu and choose from:

- Auto - Automatically selects audio as detected.
- HDMI Ch 1-8 - The embedded audio being received at the KONA X HDMI Input.-
- AES/EBU Ch 1-8 - Digital audio received from the Digital Multi I/O breakout cable provided with the KONA Xpand card (optional).

**NOTE:** See "[Digital Cable Harness \(Multi IO\)](#)" on page 59. (KONA Xpand card only.)

- Analog Audio Ch 1-2 - Analog audio received from a third party breakout cable in the KONA Xpand card (optional).

**NOTE:** See "[Analog Audio Cable Harness \(Optional\)](#)" on page 60. (KONA Xpand card only.)

- SDI Ch 1-16 - The embedded audio being received on the KONA SDI In connectors.

## Host Audio

---

Selects the audio from the host computer, thus enabling the AJA hardware to monitor anything that would normally be presented via the host laptop, CPU or computer monitor. For example, an editor could sample music from an online library, while concurrently playing back their NLE timeline. Or, a producer and editor could be communicating live during an editing session, using Zoom or some other video calling tool.

## Source Gain

---

Meters display the input audio levels of the source, colored green when that source is On, and gray when that source is not selected. The levels shown do not change when the gain is adjusted, because the input levels are being monitored, not the output levels.

When activated, the source gain controls can be used to adjust the monitoring output gain of that source, from +6dB to - infinity (mute). Adjustment methods include:

- Sliders - The sliders on the right can be used to change the values for each color.
- Numeric Entry - You also enter a numeric value by clicking on the displayed number, and can increase or decrease the values clicking on the up/down arrow boxes.
- Cut and Paste - Right clicking on a displayed number opens a Cut, Copy, Paste dropdown menu for convenient numeric entry.

These controls are for monitoring only, and do not change the audio recorded to a NLE file. Any actual recording level adjustments to Capture or Audio Punch In / Voice Over to Timeline operations will either need to be made upstream of the AJA input, or else via adjustments within the main NLE application (e.g. via a pass through mix tool).

## Downstream (DS) Keyer Screen

Figure 28. AJA Control Panel showing DS Keyer Screen for KONA X

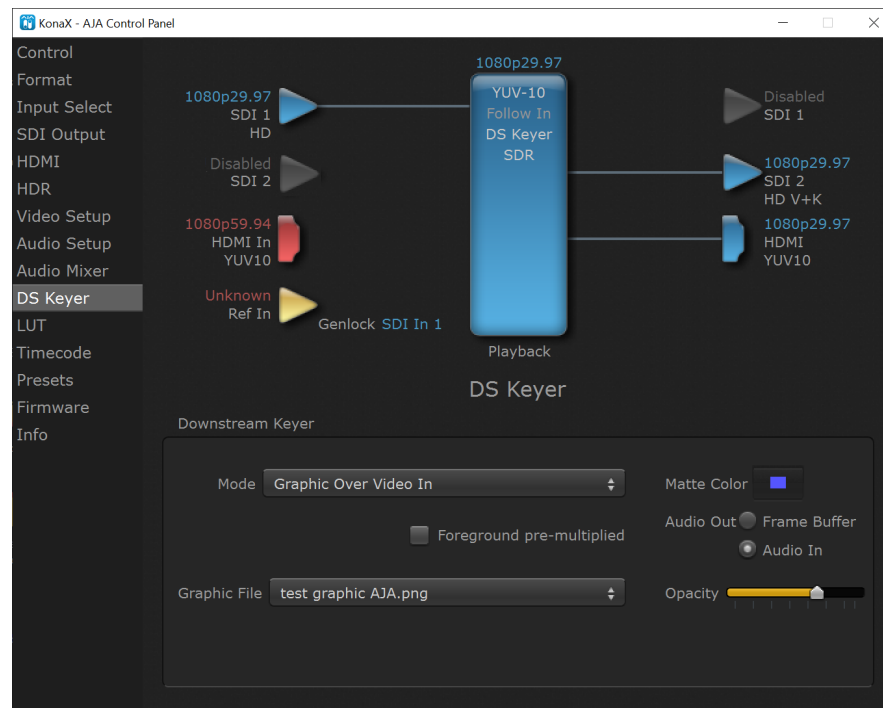

KONA cards have a hardware-based downstream keyer that is ideal for putting logos, “bugs” or other video material with an alpha channel on top of video being played out or printed to tape. Keyed video can be from the KONA X’s internal framebuffer (from storage, video In, etc.) or from a graphics file that has an alpha channel (PhotoShop etc.). Downstream keyer operation requires Control Panel to be in Playback mode.

*NOTE: KONA X’s downstream keyer works with SD/HD/2K signals only, not 4K/UltraHD signals.*

Settings in the DS Keyer Screen provide control over how the keyer operates and whether it’s turned on or off.

## Downstream Keyer

### Mode

- Downstream Keyer Off - When this dropdown menu item is selected the downstream keyer will be turned off.
- Frame Buffer over Matte - fixed color matte determined by the “Matte Color” setting set separately.
- Frame Buffer over Video In - Places the keyed video currently in the framebuffer over the video input for playout or print-to-tape.
- Graphic over Matte - Places a graphics file having an alpha channel (chosen in “Graphic File” dropdown) over a fixed color matte determined by the “Matte Color” setting set separately.
- Graphic over Video In - Places a graphics file having an alpha channel (chosen in “Graphic File” dropdown) over the video input for playout or print-to-tape.
- Graphic over Frame Buffer - Places a graphics file having an alpha channel (chosen in “Graphic File” - dropdown) over the current contents of the KONA card’s framebuffer (which might be from storage, video In, etc.).

---

## Matte Color

Only available when the dropdown “Frame Buffer over Matte” or “Graphic over Matte” are selected. Pressing this button brings up a color selection dialog. The dialog provides a variety of ways to select a matte color including a color wheel, color picker (choose from a location anywhere on the computer screen), numeric sliders, swatches, “crayons”, and spectrums. The matte chosen will be used as a video background under the keyed video.

---

## Foreground pre-multiplied

Use to avoid “matte lines” and improve the appearance of the foreground (key) being composited over the background.

---

## Audio Out

- Frame Buffer - Select audio out to be routed from the contents of the framebuffer.
- Audio In - Select audio out to be routed from KONA X's currently selected input(s).

---

## Opacity (slider)

This slider controls the transparency of the keyed video (over the background) from translucent to completely opaque.

---

## Using the Downstream Keyer

1. In the Control screen Default State pane, set 'Test Pattern (PB)' as the Default State. The test pattern may appear in video output.
2. In either the HDMI Output screen or SDI Output screen (depending on chosen output), in the Output Options pane set Select to 'Video+Key'.

*NOTE: The above two steps are required in order for DS Keyer screen settings to affect video output.*

3. In the DS Keyer Screen, in the Downstream Keyer pane select the desired keying Mode.

*NOTE: See "Mode" on page 45.*

---

## Keying Mode Examples

*Figure 29. DS Keyer example over Video In*



Figure 30. DS Keyer example over Matte

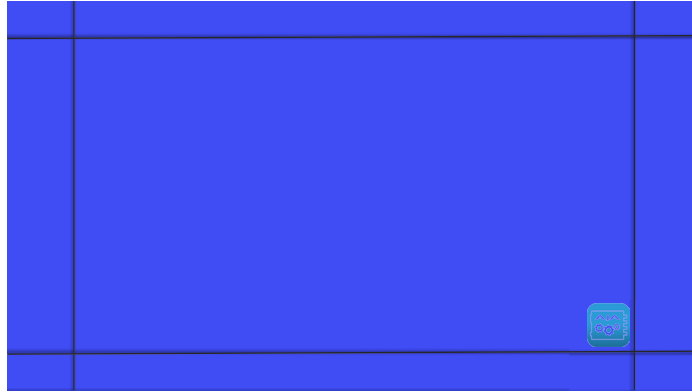
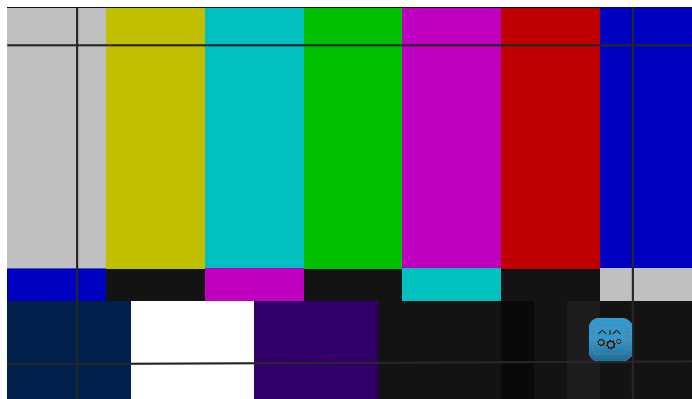

Figure 31. DS Keyer example over Frame Buffer



## Graphic File

This dropdown allows you to choose from any recently accessed file or select a new file ("Load File..."), which then brings up a file dialogue. Remember that the file raster (pixel x pixel count) should match the Device Format in the framebuffer or the Converted Format if upconverting. Example: you wish to key a logo on top of your 1920x1080 footage, the still image with alpha channel that you load should be 1920x1080. See ["Graphic Selection and Matte Color Selection" on page 48](#).

## Matte Color Selection

Clicking on the Matte Color button in the Downstream Keyer pane of DS Keyer screen brings up the color selection dialog:

Figure 32. Graphic Selection and Matte Color Selection

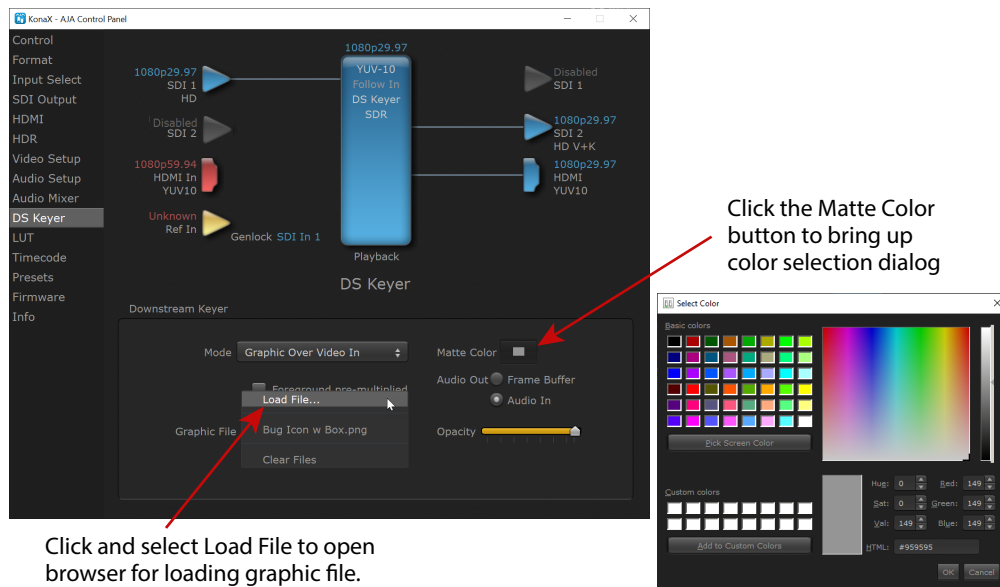

Click and select Load File to open browser for loading graphic file.

## LUT Screen

Figure 33. AJA Control Panel LUT Screen

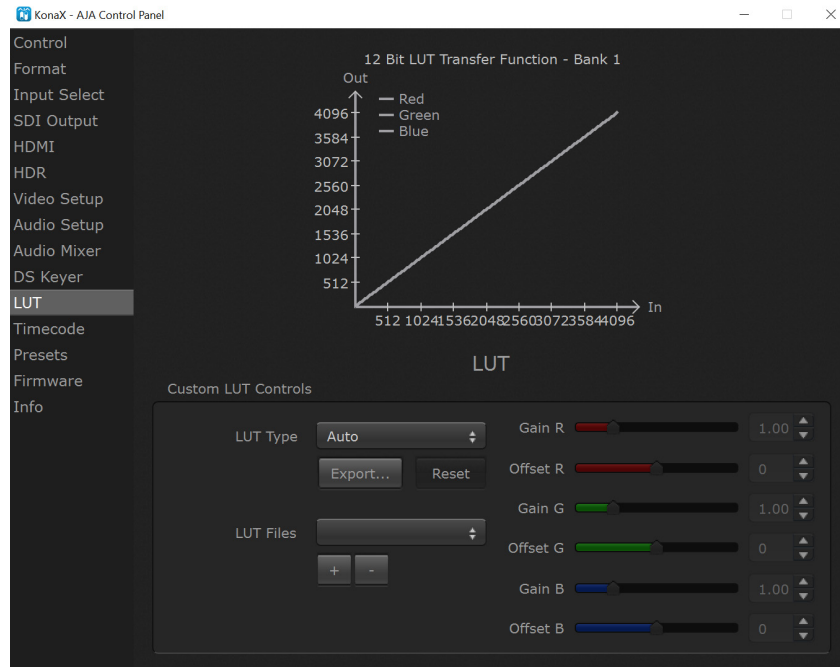

The LUT screen allows you to create a custom 10-bit color look up table (LUT) on the KONA X output, for matching a production "look" on a specific display. These custom LUTs can also be exported as .cube files for use with supported AJA devices and compatible professional applications. Users can also load externally generated LUT files into the KONA X to ensure consistent color among different devices.

**NOTE:** *.cube files are the standard for importing and exporting LUTs with AJA Control Room. Prior to v16.2, Control Room supported CSV files containing LUT information. While this LUT formatting is still supported for import, it is no longer supported for export.*

## Custom LUT Controls

The LUT Transfer Function screen displays an approximate representation of the effect of the current LUT settings. When the controls are activated by selecting a User LUT Type, Red, Blue, and Green curves show the transfer functions of each color.

**NOTE:** *The displayed curves are approximate. Curves for some extreme settings may diverge significantly from the actual transfer functions.*

### LUT Type

Selects the type of LUT. Choose from

- Auto - LUT will be automatically selected. This setting intelligently applies the type of LUT required in the majority of use cases. For example, if the framebuffer is set to SD 608 and the Output set to HD 709, then an industry standard curve for changing 608 to 709 color space is applied.
- Linear - A linear 1:1 LUT is applied, resulting in no color change (every value for source is mapped to the same value for output).
- SMPTE-FullRange - A conversion LUT from SMPTE to Full Range is applied.
- FullRange-SMPTE - A conversion LUT from Full Range to SMPTE is applied.
- User Linear - Activates the Gain and Offset controls, allowing the manual creation of a custom LUT. Initial default setting is linear.
- User Log - Activates the Gain and Offset controls, allowing the manual creation of a custom Log LUT.

**Figure 34.** Example Linear LUT Transfer Function curves

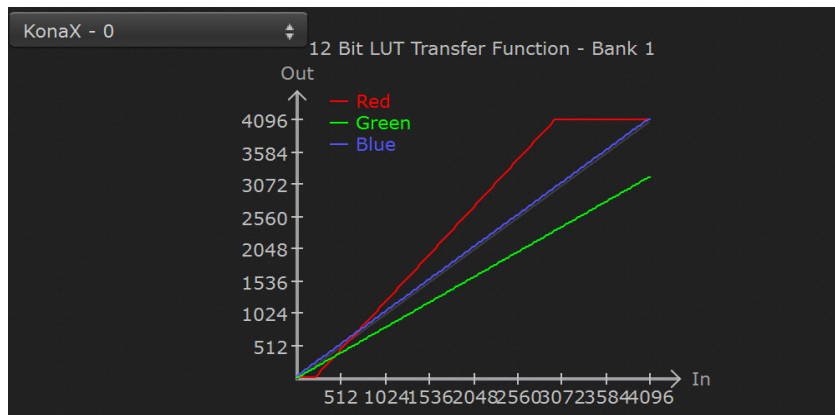

- User LUT File - See "[LUT Files](#)" on page 50 for more information.

*Figure 35. Example Gain and Offset controls*

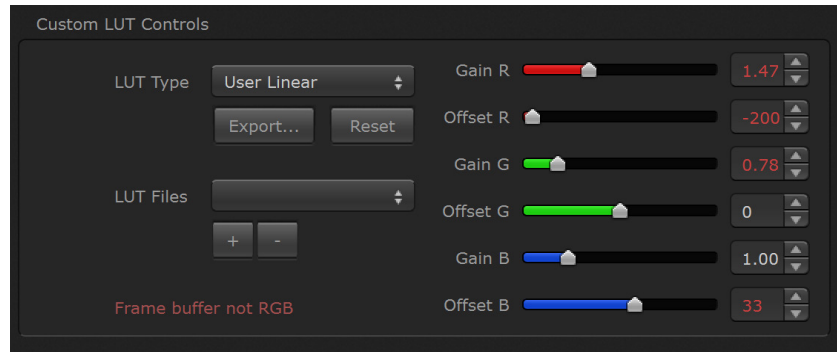

**NOTE:** The Linear RGB gain and RGB offset values shown above correspond to the previous figure, Example Linear LUT Transfer Function Curves.

When activated, the controls on the right allow adjustment of Gain and Offset for Red, Blue and Green.

- Sliders - The sliders on the right can be used to change the values for each color.
- Numeric Entry - You also enter a numeric value by clicking on the displayed number, and can increase or decrease the values clicking on the up/down arrow boxes.
- Cut and Paste - Right clicking on a displayed number opens a Cut, Copy, Paste dropdown menu for convenient numeric entry.

### Export

The Export button can be used to save the current LUT values as a .cube file. The LUT file can be named and you can specify the location to save the file. This Export feature lets you take the custom LUT with you and re-import it to another system or location for consistency.

### Reset

Clicking on the Reset button resets the currently selected LUT Type to its default values (not active for a User LUT file).

## LUT Files

The User LUT File setting above activates the LUT Files dropdown, allowing the selection of a previously saved LUT file. You can create a custom LUT file using most text editors or spread sheets, provided the data is arranged according to the LUT File Format Specification that follows (see ["LUT File Format Specification" on page 51](#)).

### Uploading Custom User LUT file

Once the LUT file is created, you can upload it with the following steps:

1. Before loading a LUT, make sure you are using an RGB/RGBA framebuffer format, and that you have a AJA Video Device that supports LUTs.
2. Open AJA Control Panel and select the "LUT" pane.
3. Click the "LUT Type" popup and choose "User LUT File" menu item. Note "LUT Files" options become enabled.
4. Click the "+" button and use the navigation dialog to choose a custom LUT file. The LUT is now loaded.

## LUT File Format Specification

LUT files are normal text files that contain 1025 lines (numbered 0 - 1024). Each line contains three integer values in the range 0 - 1023, representing 10 bit R, G, B component output values. Component values may be separated by one or more commas, spaces, or tabs. The example below show LUT File contents for Line 0, Line 1, Line 2, and Line 1024, with several valid ways to separate the numbers in a line.

- 16, 17, 17
- 17 18 18
- 19 19 21
- 1000, 1022, 1023

In the example above, the first line (Line 0) represents the output values for the case where R=0, G=0, or B=0. In other words, if the R component of a pixel is set to 0, then set R component value to 16. Likewise, if G is set to 0, then set G to 17. The second line (Line 1) does a similar thing for input component values equal to one.

A simple way to construct a LUT file is to go to user linear in Control Panel and make some modifications, then click export and you will have a .cube file. You can then either import that LUT on a different workstation, or else use a text editor to make manual adjustments if desired.

## Timecode Screen

Figure 36. AJA Control Panel Timecode Screen (Playback mode)

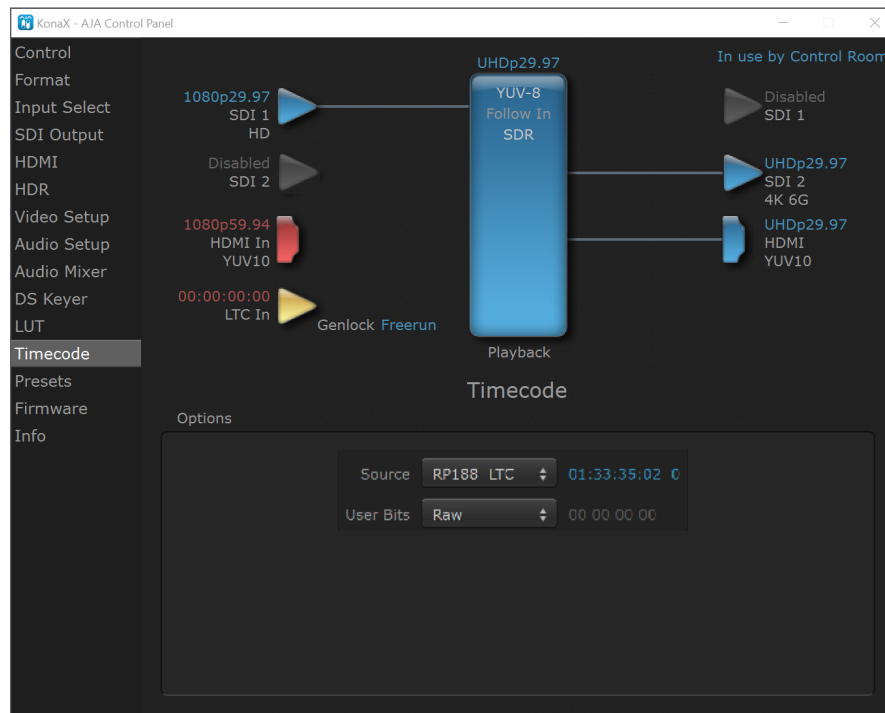

The Timecode Screen selects the timecode stream read for applications that use it (for example, when the timecode source is set to "Use control panel setting," AJA Control Room will read the selected stream). It is also used for monitoring the RP-188 timecode embedded in the digital data stream.

## Options

### Source

In RP-188 timecode (SMPTE 12M-2) there can be multiple timecode types in the data stream. Use this drop-down to select the one you wish to monitor:

- RP188 LTC (Linear timecode)
- RP188 VITC (Vertical Interval timecode)
- LTC Port input

The selection will be displayed in the timecode value to the right of the drop-down.

### User Bits

Select from Raw or VFR. For monitoring a variable framerate (VFR) timecode (such as Varicam), you may wish to select VFR for User-bits. KONA will detect and interpret the user-bits and display them next to the checkbox. You will see the original framerate (30 fps in the figure below) followed by the adjusted frame padding (two digits reporting discarded and retained frame padding).

**NOTE:** *SMPTE 12M-2 is the updated name and specification for what was RP-188. SMPTE RP 188 defines a standard for the transmission of time code and control code in the ancillary data space of a digital television data stream. Time code information is transmitted in the ancillary data space as defined in ANSI/SMPTE 291M. Multiple codes can be transmitted within a single digital video data stream. Other time information, such as real time clock, DTTR tape timer information, and other user-defined information, may also be carried in the ancillary time code packet instead of time code. The actual information transmitted through the interface is identified by the coding of a distributed binary bit. Equipment manufacturers can use the metadata for different purposes.*

## Presets Screen

Figure 37. AJA Control Panel Presets Screen (saving a Preset)

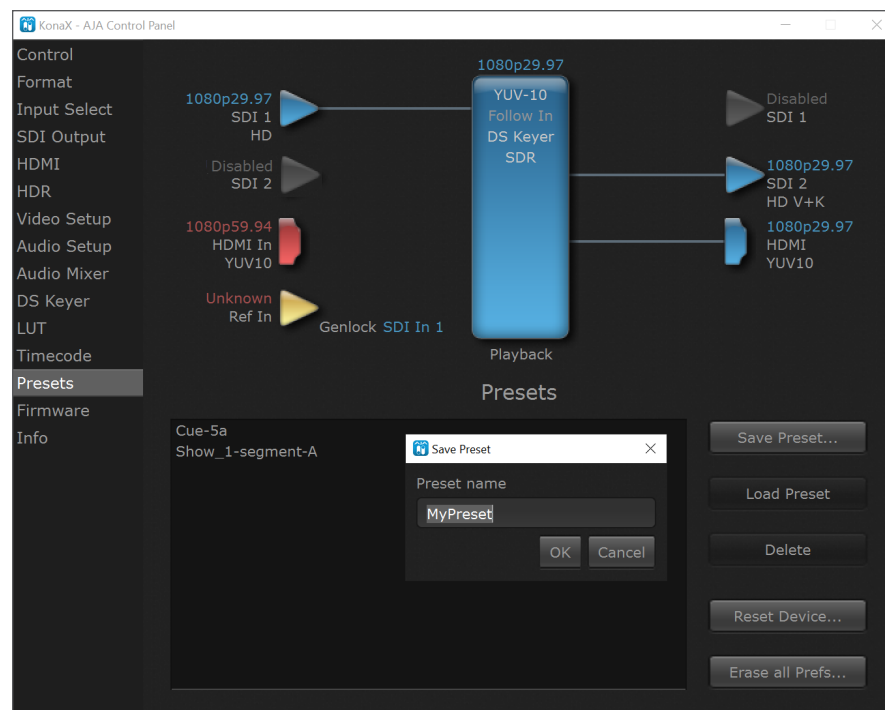

After configuring the AJA Control Panel screens, you can then save all your settings as a snapshot for later recall—called a preset. In this way, you can organize presets for all your typical tasks, eliminating manual reconfiguration each time. To save a preset, go to the Presets screen and click “Save Preset.” A dialog will be presented asking you for a name; enter a meaningful name and click “OK”. Thereafter the preset will be available under the Control Panel “Presets” list.

---

### Loading and Saving Presets

From the Presets Screen you can manage your collection of presets easily. To Load or Delete a stored preset, just select it with your mouse and then click the “Load Preset” or “Delete” button respectively.

---

### Transferring Saved Presets

If you want to use a saved Preset on another workstation, you can simply copy the file on removable storage and install it at the new location. The Preset file is always stored at:

- ~/Library/Application Support/AJA/<device name> Presets/ [on Mac]
- c:\Users\<username>\AppData\Local\AJA\Control Panel\<device name> Presets\ [Windows 8]

---

### Reset to Default

When you click the ‘Reset to default’ button the control panel will delete the User’s preference file and do one of the following:

- If “Shared” preferences exist, they are reloaded and the device is set to this state.
- If the “Shared” preferences file does not exist, “factory defaults” are loaded and the device is set to this state.

---

### Erase all Prefs

For technical support purposes you may be required to remove Preference settings. This button automates that function. If activated, all your preference setting will be lost.

For more information on Preset preferences see [“Single-User & Shared Preferences” on page 24](#).

# Firmware Screen

Figure 38. AJA Control Panel Firmware Screen

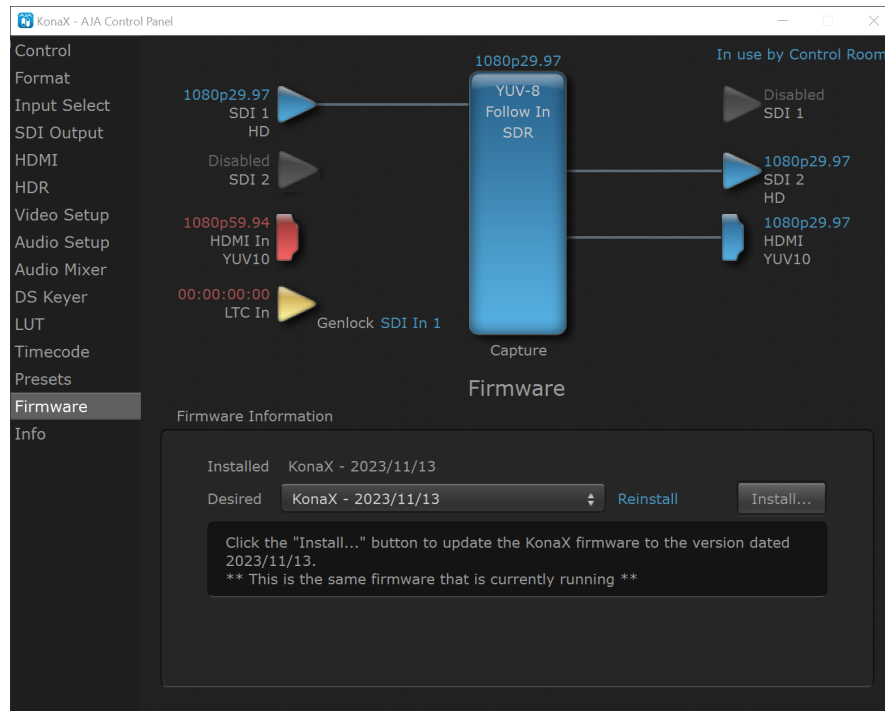

Use the Firmware link to access the firmware update/changeover screen.

Click **Install** to erase the current firmware and load the desired firmware.

You will be required to power-cycle your computer to finish the changeover.

*NOTE: See "Firmware Update Procedure" on page 17 for complete details.*

## Info Screen

Figure 39. AJA Control Panel Info Screen

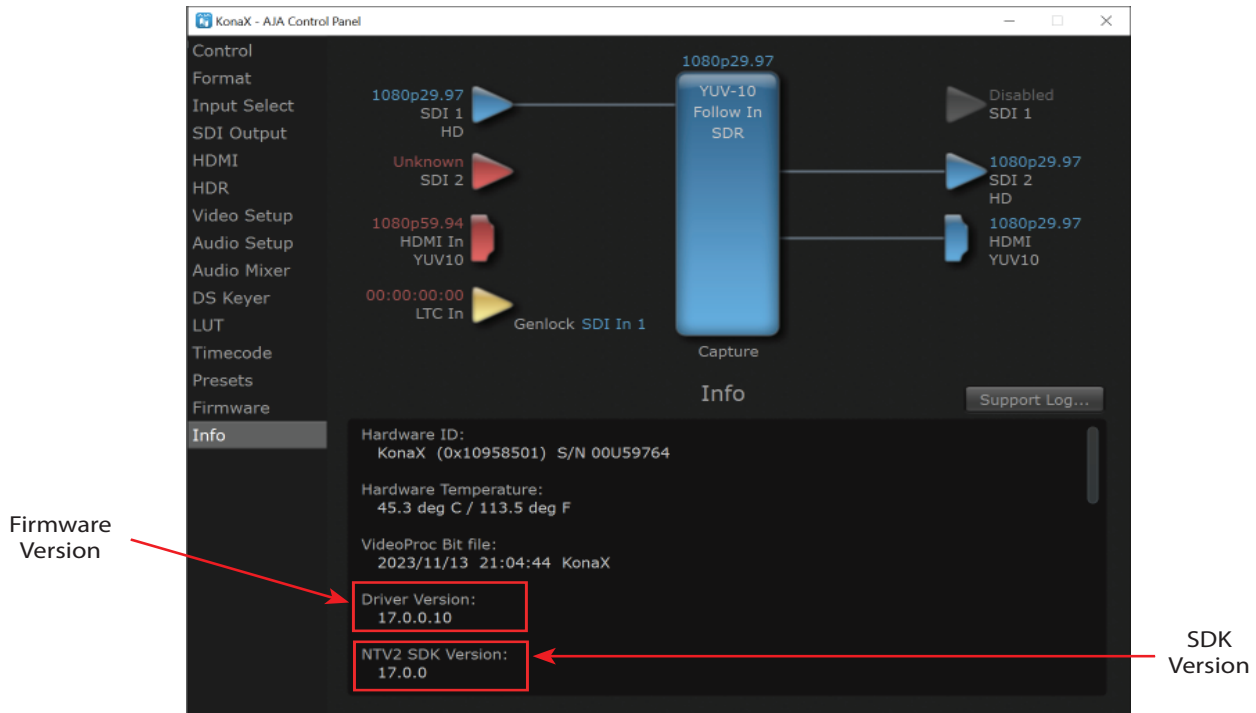

This screen shows the software files that have been installed on your system. This information may be needed if you talk to an AJA Customer Service representative to determine if files are missing or need updating.

The current firmware and SDK versions for the KONA X are shown in the fields specified above.

## About RGB and YCbCr (YUV) Video

KONA supports both YCbCr (also commonly called YUV) and RGB pixel formats. Because the KONA (and SMPTE SDI's) native format is YCbCr, AJA recommends using a YUV Pixel Format. YUV provides headroom for "superwhite" and "superblack", and these video levels will be clipped when transcoding to RGB. Also, RGB/YUV transcoding involves a level translation that results in mathematical round-off error.

# AJA Control Room

## Control Room Overview

AJA Control Room™ enables professional quality video and audio capture, conversion, playback, and output for 8K, 4K, HD and SD. With AJA Control Room you can:

- Playback professional file-based sources with or without AJA Video hardware attached.
- Capture from live feeds, cameras, consoles, and disk/tape-based sources to highest quality uncompressed and compressed video files.
- Playout or Master-to-tape using a single application.
- Configure your video/audio I/O via an AJA device using the AJA Control Panel launched from the AJA Control Room application.

## Control Room User Interface

Figure 40. AJA Control Room Screen Layout

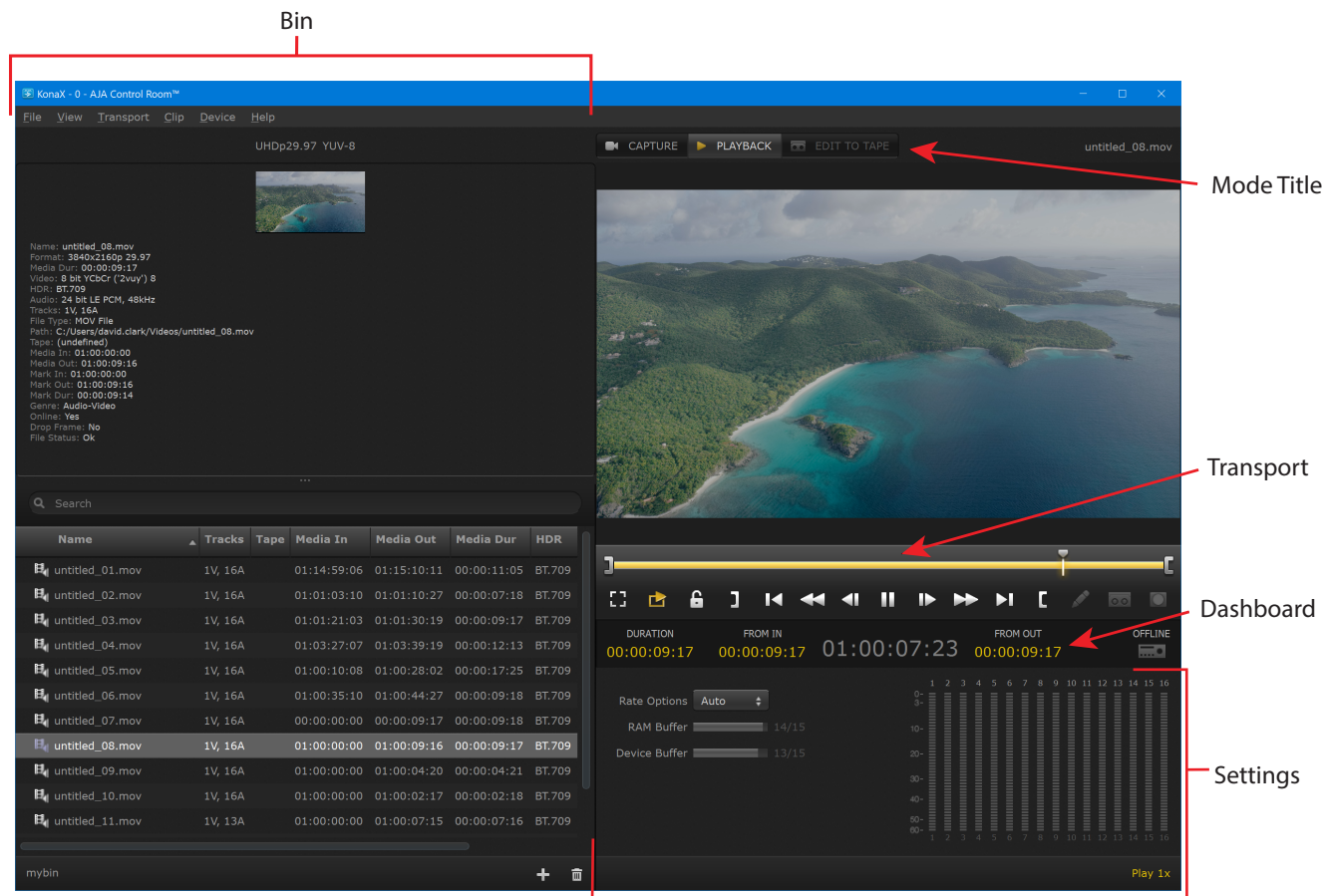

NOTE: See <https://www.aja.com/products/aja-control-room#support> for Control Room Manual download.

## Control Room Screen Layout

---

Besides displaying playback or capture video, the Control Room screen is divided into different panes, which can be shown or hidden as desired.

- Bin - Shows the clips currently imported into the bin and information for them
- Mode Title - Shows the Capture, Playback and Edit to Tape selection tabs
- Transport - Contains clip playback controls
- Dashboard - Displays information for the currently loaded clip
- Settings - Shows controls

## Control Room Operating Modes

---

Control Room has three operating modes. Mode Select Tabs at the top of the page allow you to easily switch between Capture, Playback and Edit To Tape modes.

**Capture** - The Capture screen allows capturing video and audio to the computer from an external video/audio source, such as a VTR/DDR, using the AJA hardware.

**Playback** - The Playback screen loads files from your computer and plays them out through your AJA hardware.

**Edit To Tape** - This is a workspace where you can perform an insert or assemble Edit to Tape to record your clips to a VTR/DDR.

# Chapter 4 – KONA Xpand Card

## Introduction

In addition to the KONA X card, an optional KONA Xpand breakout I/O board is available which is specifically designed to work with it. It contains circuitry for analog audio, reference, GPIO\*, balanced AES/EBU audio, balanced analog audio and LTC in/out. This optional board is valuable to users who require additional IO breakout functionality in their KONA X system.

*NOTE: \*GPIO requires a user-supplied cable.*

## KONA Xpand Card

Figure 41. KONA Xpand PCIe card and its connections

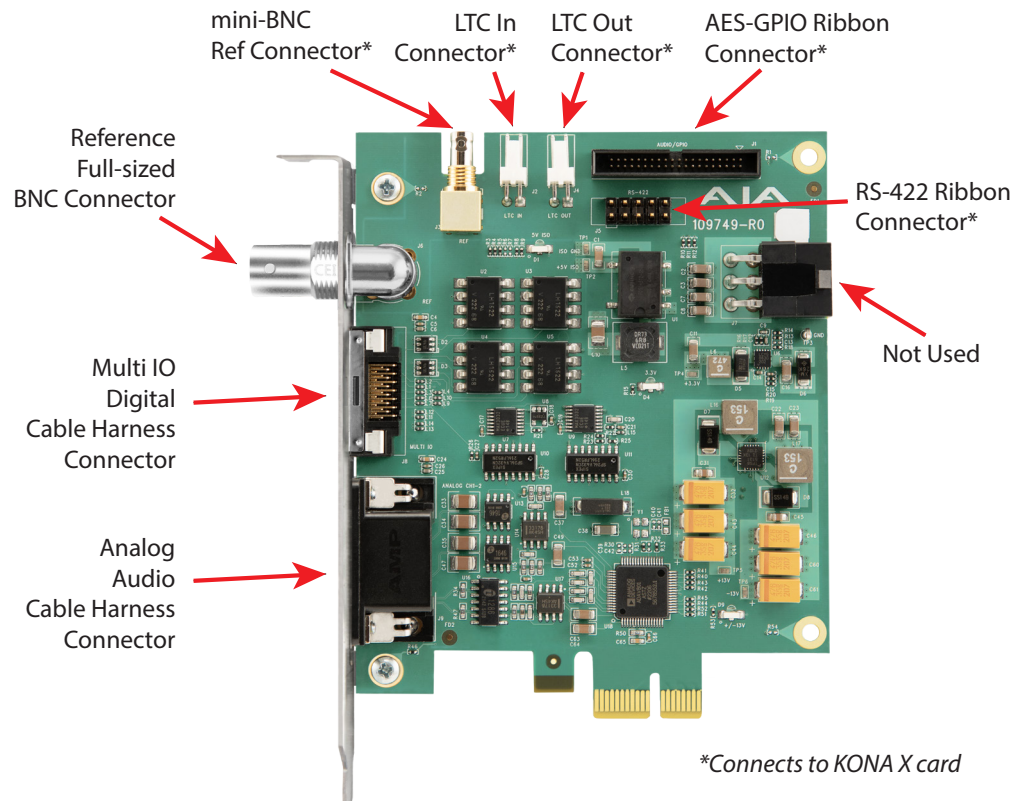

The KONA Xpand I/O board sits in an adjacent PCIe slot, and draws PCIe bus power.

*NOTE: While there is a Power Connector on the KONA Xpand card, it is not used and should remain disconnected.*

Figure 42. Xpand Card edge SDI Ref, Multi IO and Analog Audio connectors

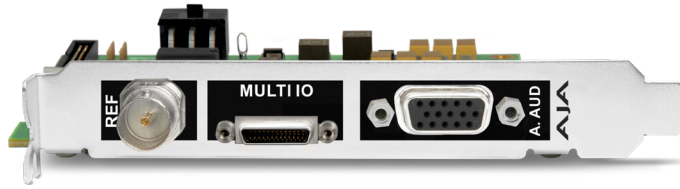

## KONA Xpand Card Features

- Bilevel/Trilevel Video Reference (full-sized BNC)
- LTC In / Out (full-sized BNC)
- RS-422 (Using optional Multi IO cable harness)
- 2 channels of balanced analog audio In / out (Using user supplied cable such as the Laird ED-BE-2XMF-003.)

## KONA Xpand Cable Options

### Digital Cable Harness (Multi IO)

This cable is included and ships with the KONA Xpand card.

Figure 43. KONA Xpand Multi IO Breakout Cable harness



**NOTE:** The MULTI IO breakout cable harness can be used with either the KONA Xpand or KONA 5 cards.

Figure 44. Multi IO Breakout Cable Harness connectors

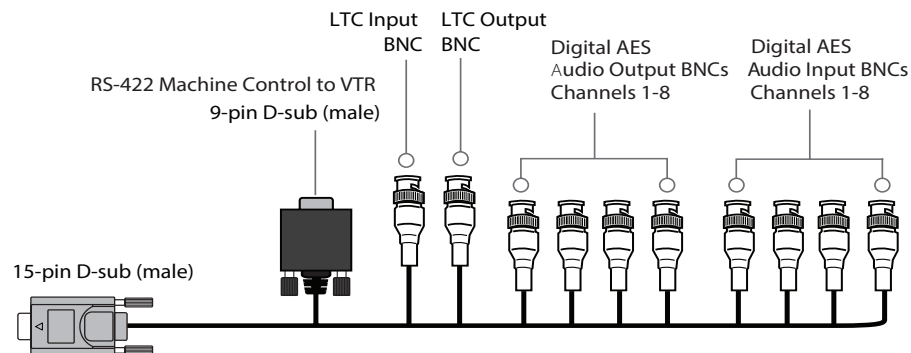

- Up to four channel pairs of AES audio on full size BNC connectors, configurable as two pairs in and two pairs out, or all four pairs in, or all four pairs out

- Reference In/LTC In (selectable) full size BNC connector
- LTC Output full size BNC connector
- RS-422 control via 9-pin D connector which provides a control path for VTRs, camcorders, disk media servers, and other devices using RS-422 SMPTE (Sony) protocol. The RS-422 connector on the provided Micro IO break-out cable is male.

## Analog Audio Cable Harness (Optional)

Figure 45. Analog Audio Cable Harness (3rd-Party)



NOTE: Example shown above is for illustration purposes only. Actual cable may vary according to manufacturer.

Figure 46. Analog Audio Cable Harness Connectors

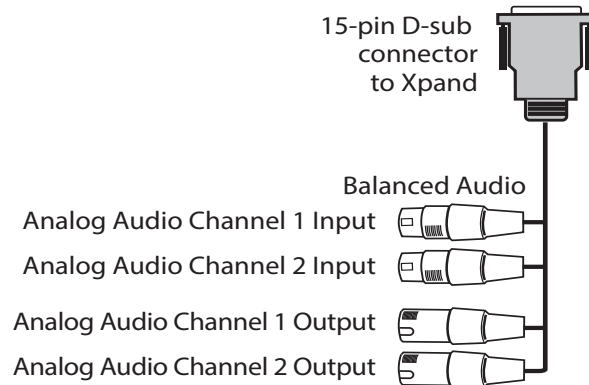

## LTC/Ref

KONA Xpand card supports both Reference and Linear Time Code inputs. Select from:

- Reference - Receives bi-level or tri-level reference on the "Ref" labeled BNC input on the KONA Xpand card.
- LTC - Receive or sends timecode using the LTC BNC cables on the digital breakout cable harness, including with KONA Xpand card.

## Cables between KONA Xpand and KONA X Cards

In addition to installing the KONA Xpand card into a PCIe slot, installation also involves connecting five cables which connect the KONA Xpand and KONA X cards to each other:

- Reference mini-BNC to mini-BNC cable
- AES-GPIO Ribbon cable
- RS-422 Ribbon Cable
- LTC In Cable
- LTC Out Cable

Figure 47. KONA Xpand to KONA X card cables

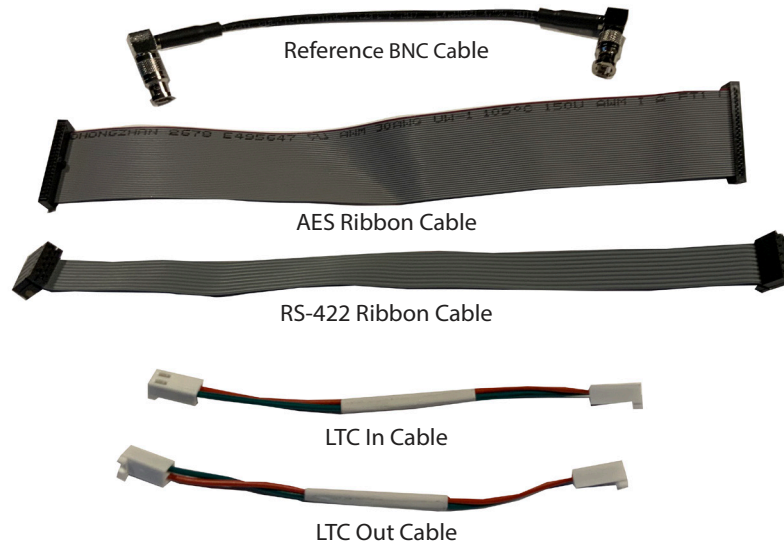

Below we show a top view of the two cards and the five cables after they have been correctly installed.

Figure 48. KONA Xpand to KONA X card cables, all connected (top view)

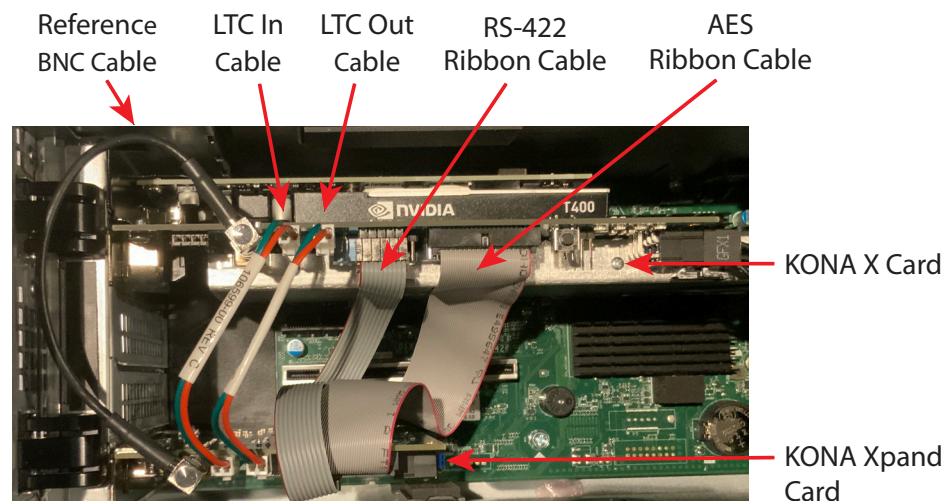

We detail the installation procedure below.

# KONA Xpand Installation

The KONA Xpand installation process is comprised of four phases:

1. Prepare to install.
2. Connect cables to KONA X.
3. Connect cables to KONA Xpand.
4. Install KONA Xpand into PCIe slot.

The KONA Xpand card may be installed into a PC chassis, legacy Mac Pro chassis with PCIe slots, or into a Thunderbolt PCIe external chassis.

## Prepare to Install

1. Turn off power to the host chassis.
2. Touch the outside of the chassis to discharge any body static.
3. Remove the AC power cable from the back of the chassis.
4. Open the chassis.
5. If not previously done, install the KONA X card into the chassis.  
*See "Installing the KONA X Card" on page 12.*

**IMPORTANT:** The KONA X card requires ATX power. To use a Thunderbolt 3 expansion chassis, the chassis must provide ATX connectivity and adequate power. The KONA Xpand card does not require ATX power.

## Connect Cables to KONA X Card

1. Connect an AES ribbon cable to the KONA X card's AES Ribbon Connector. Refer to the orientation key on the connector, to align it correctly.
2. Connect an RS-422 ribbon cable to the KONA X card's RS-422 Ribbon Connector.

**WARNING:** Since there is no orientation key on the connector, it is possible to connect it while accidentally inverted, and then proceed to power up (which is likely to be problematic).

**CAUTION:** Make sure that the red "pin-one" stripe on the ribbon cable is oriented as shown in the figure below.

Figure 49. KONA X card connectors showing correctly oriented cables

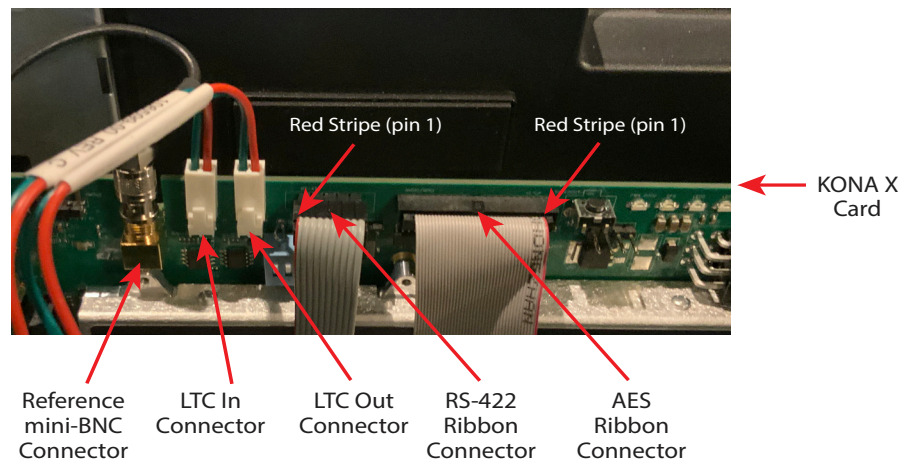

3. Connect an LTC cable to the LTC In Connector on the KONA X. The "orientation keys" on the cable connectors make them easy to align.

4. Connect an LTC cable to the LTC Out Connector on the KONA X.
5. Connect a mini-BNC cable to the mini-BNC Ref Connector on the KONA X.

## Connect Cables to KONA Xpand Card

Access to the connectors on the KONA Xpand card, once it is inserted into its PCIe slot, may be too difficult if the slot is rear the edge of the chassis. If so, we recommend connecting the free ends of the five cables previously attached to the KONA X card above, to the KONA Xpand card. Do this first, even before the KONA Xpand card is installed into the chassis.

**CAUTION:** Take care to protect the loose KONA Xpand card from static charge or other damage while connecting the cables, and before it is installed into the chassis.

1. Touch the chassis to discharge any body static.
2. Remove the KONA Xpand card from its anti-static bag (if still in it).
3. Connect the LTC cable from the Kona X LTC In to the LTC In Connector on the KONA Xpand card.

**CAUTION:** Do not connect an LTC In on either board to an LTC Out on the other board. Doing so could have unpredictable results.

4. Connect the LTC cable from the KONA X LTC Out to the LTC Out Connector on the KONA Xpand card.
5. Connect the AES ribbon cable from KONA X to the KONA Xpand AES Ribbon Connector. Refer to the orientation key on the connector, to ensure the correct alignment.
6. Connect the RS-422 ribbon cable from KONA X to the KONA Xpand RS-422 Ribbon Connector.

**CAUTION:** There is no orientation key on this connector, so it is physically possible to accidentally invert it and proceed to power up.

**WARNING:** Do not connect the RS-422 with the incorrect pin-one orientation, as indicated by the red stripe on the edge of the ribbon. Connecting this cable in reverse-pins-order could damage PCIe card electronics and/or damage connected equipment.

Figure 50. KONA Xpand card connectors showing correctly connected cables

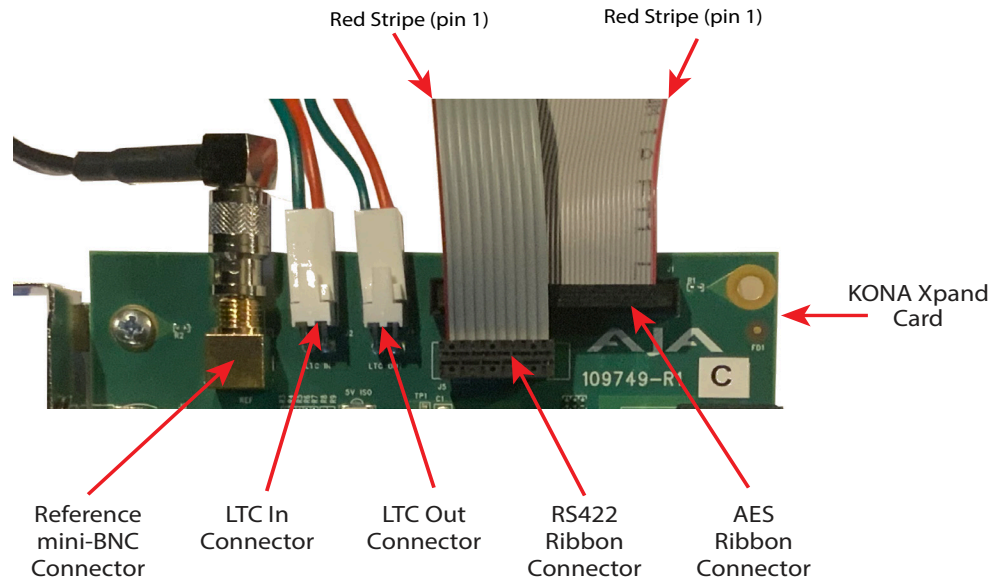

7. Connect the mini-BNC cable from the KONA X Ref Connector to the mini-BNC Connector on the KONA Xpand card.

## Install Xpand Card into Chassis

---

1. Locate a recommended PCIe slot (see "[Installation Overview](#)" on page 11 for more information). It should also be a PCIe slot near the KONA X card previously installed.

*NOTE: Always put a RAID controller (if any) and KONA Xpand card on separate PCIe buses. This improves performance by reducing bus contention.*

2. Remove the blank backplate from the PCIe slot, if one was present.
3. While keeping the connected five cables in a good position, carefully insert the KONA Xpand card into its chosen slot by rocking it slowly into the slot.
4. Ensure the card's edge bracket aligns properly with the chassis while the card is fully seated in the PCIe slot. If possible, choose a slot configuration which allows the ribbon cables to stay flat, instead of twisting.
5. Secure the KONA Xpand card and its rear bracket in the chassis.

*NOTE: Do not connect the KONA Xpand card to a chassis ATX power cable. The KONA Xpand card only draws power from the PCIe bus. See "[KONA Xpand PCIe card and its connections](#)" on page 58.*

6. Gently tuck down the card-to-card cables to keep them out of the way in the enclosure, as needed.
7. Visually double-check that both KONA X and KONA Xpand cards are securely seated all the way down in their respective PCIe slots.
8. Visually double-check that all cable connectors are firmly and fully seated.
9. Close the chassis.
10. Reconnect the AC Power cable to the chassis.
11. Power up the chassis.

## Xpand Operation

---

There is no direct user control or operation of the KONA Xpand card itself. It exclusively operates under the KONA X card and the KONA X's associated software applications (including AJA Control Panel and AJA Control Room).

In the AJA Control Panel application, controls and parameters exclusive to the KONA Xpand card analog and digital cable harness connections only appear in the Audio Mixer screen menus when a KONA Xpand card is installed.

See "[Audio Mixer Screens](#)" on page 41.

# KONA Xpand Example System Connections

Figure 51. Example KONA X with KONA Xpand system connections

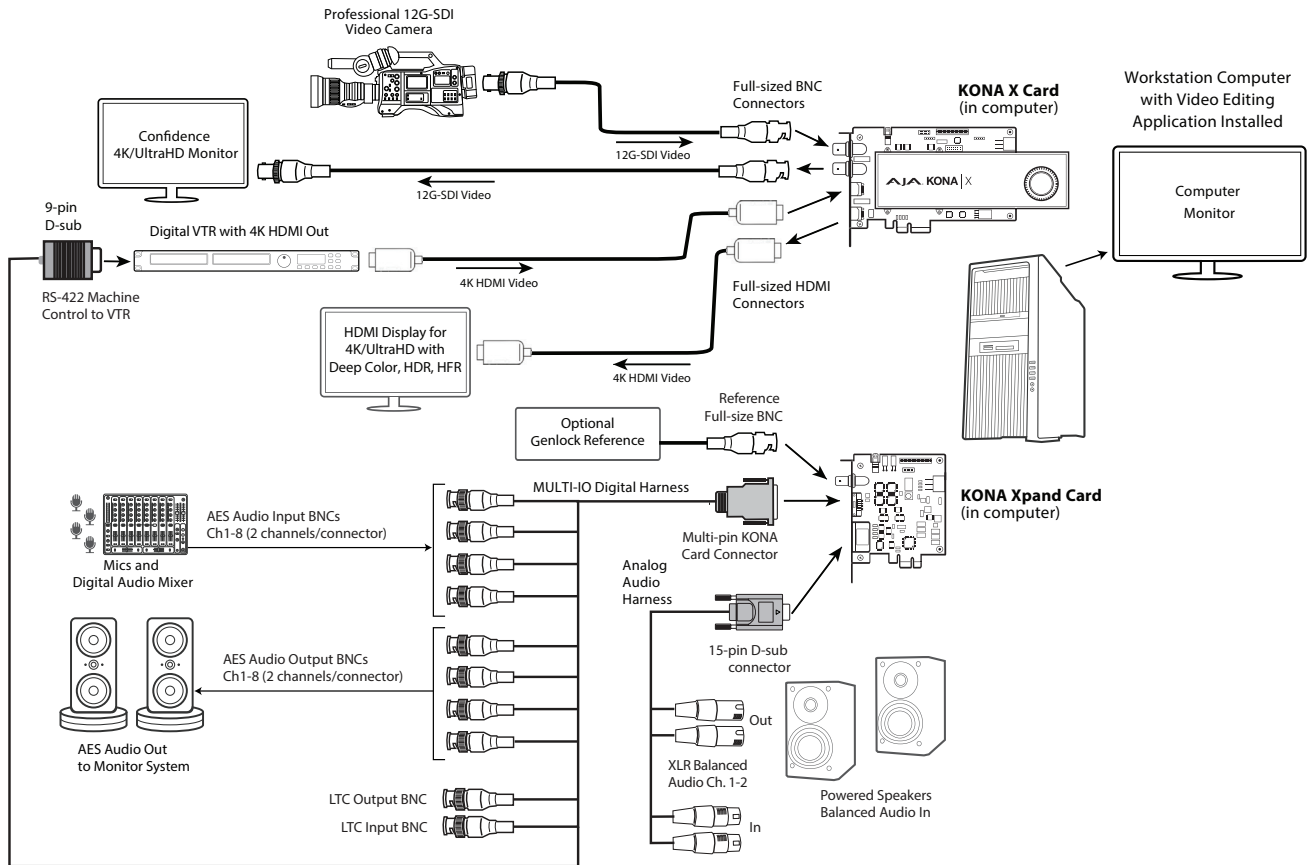

**NOTE:** Internal cable connections between the KONA X and KONA Xpand cards are not shown. See ["Cables between KONA Xpand and KONA X Cards"](#) on page 61.

# Appendix A – Specifications

---

## KONA X Tech Specs

---

### SDI Video Formats

---

- (4K) 4096 x 2160p 23.98, 24, 25, 29.97, 30, 47.95, 48, 50, 59.94, 60
- (UltraHD) 3840 x 2160p 23.98, 24, 25, 29.97, 30, 50, 59.94, 60
- (2K) 2048 x 1080p 23.98, 24, 25, 29.97, 30, 47.95, 48, 50, 59.94, 60
- (2K) 2048 x 1080PsF 23.98, 24, 25, 29.97, 30
- (HD) 1920 x 1080p 23.98, 24, 25, 29.97, 30, 50, 59.94, 60
- (HD) 1920 x 1080PsF 23.98, 24, 25, 29.97, 30
- (HD) 1920 x 1080i 50, 59.94, 60
- (HD) 1280 x 720p 50, 59.94, 60
- (SD) 625i 50
- (SD) 525i 59.94

### HDMI Video Formats

---

- (4K CEA) 4096 x 2160p 23.98, 24, 25, 29.97, 30, 47.95, 48, 50, 59.94, 60
- (UltraHD) 3840 x 2160p 23.98, 24, 25, 29.97, 30, 50, 59.94, 60
- (2K CEA) 2048 x 1080p 23.98, 24, 25, 29.97, 30, 47.95, 48, 50, 59.94, 60
- (HD) 1920 x 1080p 23.98, 24, 25, 29.97, 30, 50, 59.94, 60
- (HD) 1920 x 1080i 50, 59.94, 60
- (VESA DMT) 1600 x 1200p 60
- (VESA DMT) 1280 x 1024p 60
- (HD) 1280 x 720p 50, 59.94, 60
- (VESA DMT) 1024 x 768p 60
- (VESA DMT) 800 x 600p 60
- (SD) 625i 50
- (SD) 525i 59.94
- (VESA DMT) 640 x 480p 60

*NOTE: Additional VESA (DMT) formats supported for certain applications*

## Video Inputs Digital

---

- 12G-SDI, SMPTE-2082, 12-bit, 10-bit
  - YCbCr 4:2:2 10-bit up to 60p, RGB 4:4:4 12-bit up to 30p
- 6G-SDI, SMPTE-2081, 10-bit
- 3G-SDI, SMPTE 425
  - RGB 4:4:4 12-bit, YCbCr 4:2:2 10-bit
- 1.5G-SDI, SMPTE 292M
  - Single Link HD-SDI YCbCr 4:2:2 10-bit
- 270 Mbps SDI, SMPTE 259M-C
  - YCbCr 4:2:2 10-bit, 8-bit
- HDMI v2.0
  - 30/36-bits/pixel, RGB or YUV, 6 Gbps per color component
  - 4K, UltraHD, 2K, HD, and SD
  - YCbCr 4:2:2 10-bit up to 60p, RGB 4:4:4 12-bit up to 30p
  - Connectors are Full Size BNC / Full Size HDMI
  - HDMI Inputs and Outputs support VESA (DMT) rasters at limited rates

## Video Outputs Digital

---

- 12G-SDI, SMPTE-2082\*, 12-bit, 10-bit
  - YCbCr 4:2:2 10-bit up to 60p, RGB 4:4:4 12-bit up to 30p
- 6G-SDI, SMPTE-2081\*, 10-bit
- 3G-SDI, SMPTE 425
  - RGB 4:4:4 12-bit, YCbCr 4:2:2 10-bit
- 1.5G-SDI, SMPTE 292M
  - Single Link HD-SDI YCbCr 4:2:2 10-bit
- 270 Mbps SDI, SMPTE 259M-C
  - YCbCr 4:2:2 10-bit, 8-bit
- HDMI v2.0
  - 30/36-bits/pixel, RGB or YUV, 6 Gbps per color component
  - 4K, UltraHD, 2K, HD, and SD
  - YCbCr 4:2:2 10-bit up to 60p, RGB 4:4:4 12-bit up to 30p
  - Connectors are Full Size BNC / Full Size HDMI
  - HDMI Input and Output support VESA rasters

*NOTE: \*Compliant with subsets of specification for supported formats*

## HDR

---

- SDI: VPID signaling for SDR/HDR Transfer Characteristics, Colorimetry, and Luminance
- HDMI: HDR10 Support - HDR Infoframe metadata, compatible with HDMI 2.0a/CTA-861.3
- HDMI: HLG Support - compatible with HDMI 2.0b/CTA-861-G

## SDI I/O (via PCIe Bracket)

---

- •2x full-size 12G-SDI connections
- •SDI connections are bidirectional
  - Single channel SDI capture (plus simultaneous SDI pass-through monitoring)
  - Single channel SDI output

## HDMI I/O (via PCIe Bracket)

---

- 2x full-size (Type A) HDMI 2.0 connections
- HDMI connections are uni-directional (1x Input, 1x Output)
  - Single channel HDMI input
  - Single channel HDMI output

## HDMI Monitoring for SDI Inputs

---

- HDMI output connector supports
  - Single channel SDI source monitoring

## Video I/O Performance

---

- Capable of two channel 4K p60 capture or playback

## Audio Inputs Digital

---

- 16-channel, 24-bit SDI embedded audio, 48 kHz sample rate, synchronous
- 8-channel, 24-bit HDMI embedded audio, 48 kHz sample rate, synchronous
- 8-channel, 16 and 24-bit AES/EBU audio, 48 kHz sample rate, synchronous or nonsynchronous, internal sample rate conversion (via 4x BNC on breakout cable)

*NOTE: Audio I/O is available via optional KONA Xpand card, or via customer supplied breakout connection to internal card connector*

## Audio Input Analog

---

- 2-channel, 24 and 16-bit D/A analog audio, 48 kHz sample rate, balanced, using industry standard 2x XLR on DB-25 breakout cable (cable not included)
- +24 dBu full scale digital (0 dBFS)
- +/- 0.2 dB 20 to 20 kHz frequency response

*NOTE: Requires the optional KONA Xpand card*

## Audio Outputs Digital

---

- 16-channel, 24-bit SDI embedded audio, 48 kHz sample rate, synchronous
- 8-channel, 24-bit HDMI embedded audio, 48 kHz sample rate, synchronous
- 8-channel, 16 and 24-bit AES/EBU audio, 48 kHz sample rate, synchronous or nonsynchronous, internal sample rate conversion (via 4x BNC on breakout cable)

*NOTE: AES audio requires the optional KONA Xpand card. SDI and HDMI audio do not require the KONA Xpand card.*

## Audio Output Analog

---

- 2-channel, 24-bit D/A analog audio, 48 kHz sample rate, balanced, using 2x XLR
- +24 dBu full scale digital (0 dBFS)
- +/- 0.2 dB 20 to 20 kHz frequency response

*NOTE: Requires the optional KONA Xpand card*

## Downstream Keyer

---

- Supports graphics up to 4K/UltraHD with alpha channel over video, matte or framebuffer, or framebuffer content over incoming video or matte

## Reference

---

- Analog Color Black (1V) or Composite Sync (2 or 4V) or HD Tri-Level Sync (1V)
- Reference input is terminated into 75 ohms when Genlock is set to Ref In

*NOTE: Available via optional KONA Xpand card, or via customer supplied breakout connection to internal card*

## Timecode

---

- LTC timecode input
- LTC timecode output

*NOTE: Available via optional KONA Xpand card, or via customer supplied breakout connection to internal card*

## Electrical Interface

---

- PCIe Gen 3 x 4

## Machine Control

---

- RS-422, Sony 9-pin protocol
- 9-pin D-connector pinout is as follows:
  - 1 GND
  - 2 RX-
  - 3 TX+
  - 4 GND
  - 5 No Connection
  - 6 GND
  - 7 RX+
  - 8 TX-
  - 9 GND
- Shell GND

*NOTE: Available via optional KONA Xpand card, or via customer supplied breakout connection to internal card*

## Noise

---

- <50dBA (A-weighted at 1m in free air) <40-45dBA preferred (Phase 01 )>
- Fan is rated at 33.1dBA

## Regulatory Compliance

---

- RoHS 3
- IEC 62368-1: 2014 2nd Edition safety standard

## Size (w x d x h)

---

- Passive Configuration (no fan): 190.5mm x 15.9mm x 98.6mm (7.5in x 0.63in x 3.88in) Bracket Height: 127mm (5.0in)
- Active Configuration (with fan): 247.7mm x 15.9mm x 98.6mm (9.75in x 0.63in x 3.88in) Bracket Height: 127mm (5.0in)
- Xpand Card: 108.0mm x 15.9mm x 98.6mm (4.25in x 0.63in x 3.88in) Bracket Height: 127mm (5.0in)

## Weight

---

- PCIe Card: Active (with fan): 290.3g (10.2oz), Passive (no fan): 217.7g (7.7oz)
- Xpand Card: 90.7g (3.2oz)

## Power

---

- 20W typical with 16W on +12V and 4W on +3.3V
- PC Internal or PCI Aux Power Connector: Molex part number 45558-0003

*NOTE: Card can utilize PCIe power from a 6 pin PCI 2x3 Aux Power connector or the PCIe slot*

## Environment

---

- Safe Operating Temperature: 0 to 40 C (32 to 104 F)
- Safe Storage Temperature (Power OFF): -40 to 60 C (-40 to 140 F)
- Operating Relative Humidity: 10-90% noncondensing
- Operating Altitude: <3,000 meters (<10,000 feet)

# Appendix B – Safety & Compliance

---

## Federal Communications Commission (FCC) Compliance Notices

---

### Class A Interference Statement

---

This equipment has been tested and found to comply with the limits for a Class A digital device, pursuant to Part 15, Subpart B of the FCC Rules. These limits are designed to provide reasonable protection against harmful interference in a residential installation. This equipment generates, uses, and can radiate radio frequency energy and, if not installed and used in accordance with the instructions, may cause harmful interference to radio communications. However, there is no guarantee that interference will not occur in a particular installation. If this equipment does cause harmful interference to radio or television reception, which can be determined by turning the equipment off and on, the user is encouraged to try to correct the interference by one or more of the following measures:

- Reorient or relocate the receiving antenna.
- Increase the separation between the equipment and receiver.
- Connect the equipment into an outlet on a circuit different from that to which the receiver is connected.
- Consult the dealer or an experienced radio/TV technician for help.

### FCC Caution

---

This device complies with Part 15 of the FCC Rules. Operation is subject to the following two conditions: (1) This device may not cause harmful interference, and (2) this device must accept any interference received, including interference that may cause undesired operation.

## Canadian ICES Statement

---

### Canadian Department of Communications Radio Interference Regulations

This digital apparatus does not exceed the Class A limits for radio-noise emissions from a digital apparatus as set out in the Radio Interference Regulations of the Canadian Department of Communications. This Class A digital apparatus complies with Canadian ICES-003.

### Règlement sur le brouillage radioélectrique du ministère des Communications

Cet appareil numérique respecte les limites de bruits radioélectriques visant les appareils numériques de classe A prescrites dans le Règlement sur le brouillage radioélectrique du ministère des Communications du Canada. Cet appareil numérique de la Classe A est conforme à la norme NMB-003 du Canada.

## European Union, European Free Trade Association (EFTA) and United Kingdom Regulatory Compliance

---

This equipment may be operated in the countries that comprise the member countries of the European Union, European Free Trade Association and the United Kingdom. These countries, listed in the following paragraph, are referred to as The European Community throughout this document:

AUSTRIA, BELGIUM, BULGARIA, CROATIA, CZECH REPUBLIC, DENMARK, ESTONIA, FINLAND, FRANCE, GERMANY, GREECE, HUNGARY, ICELAND, IRELAND, ITALY, LATVIA, LIECHTENSTEIN, LITHUANIA, LUXEMBOURG, MALTA, NETHERLANDS, NORWAY, POLAND, PORTUGAL, REPUBLIC OF CYPRUS, ROMANIA, SLOVAK REPUBLIC, SLOVENIA, SPAIN, SWEDEN, SWITZERLAND, UNITED KINGDOM

## Declaration of Conformity

Marking by these symbols indicates compliance with the Essential Requirements of the EMC Directive of the European Union 2014/30/EU.



This equipment meets the following conformance standards:

### Safety

EN 62368-1: 2014 + A11 (T-Mark License),  
IEC 62368-1: 2014 (CB Scheme Report/Certificates)

### Emissions

EN 55032: 2015 + A11: 2020, CISPR 32: 2015,  
EN 61000-3-2: 2014, EN 61000-3-3: 2013

### Immunity

EN 55035: 2017 + A11: 2020, EN 61000-4-2:2009,  
EN 61000-4-3:2006+A1:2008 +A2:2010,  
EN 61000-4-4: 2012, EN 61000-4-5: 2014 +A1: 2017, EN 61000-4-6: 2014,  
EN 61000-4-11: 2020

The product is also licensed for additional country specific standards as required for the International Marketplace.



**Warning!** This is a Class A product. In a domestic environment, this product may cause radio interference, in which case, the user may be required to take appropriate measures.

**Achtung!** Dieses ist ein Gerät der Funkstörgrenzwertklasse A. In Wohnbereichen können bei Betrieb dieses Gerätes Rundfunkstörungen auftreten, in welchen Fällen der Benutzer für entsprechende Gegenmaßnahmen verantwortlich ist.

**Attention!** Ceci est un produit de Classe A. Dans un environnement domestique, ce produit risque de créer des interférences radioélectriques, il appartiendra alors à l'utilisateur de prendre les mesures spécifiques appropriées.

## Recycling Notice



This symbol on the product or its packaging indicates that this product must not be disposed of with your other household waste. Instead, it is your responsibility to dispose of your waste equipment by handing it over to a designated collection point for the recycling of waste electrical and electronic equipment. The separate collection and recycling of your waste equipment at the time of disposal will help conserve natural resources and ensure that it is recycled in a manner that protects human health and the environment. For more information about where you can drop off your waste for recycling, please contact your local authority, or where you purchased your product.

## Korea KCC Compliance Statement

사용자안내문

이 기기는 업무용 환경에서 사용할 목적으로 적합성평가를 받은 기기로서 가정용 환경에서 사용하는 경우 전파간섭의 우려가 있습니다.

## Taiwan Compliance Statement

警告使用者：  
這是甲類的資訊產品，在居住的環境中使用時，可能會造成射頻干擾，在這種情況下，使用者會被要求採取某些適當的對策。

This is a Class A product based on the standard of the Bureau of Standards, Metrology and Inspection (BSMI) CNS 13438, Class A. In a domestic environment this product may cause radio interference in which case the user may be required to take adequate measures.

## Japan Compliance Statement

この装置は、クラスA情報技術装置です。この装置を家庭環境で使用すると電波妨害を引き起こすことがあります。この場合には使用者が適切な対策を講ずるよう要求されることがあります。 VCCI-A

This is a Class A product based on the standard of the VCCI Council (VCCI 32: 2016). If this equipment is used in a domestic environment, radio interference may occur, in which case, the user may be required to take corrective actions.

## Translated Warning and Caution Messages

The following caution statements, warning conventions, and warning messages apply to this product and manual.



Warning Symbol



Caution Symbol

## Before Operation Please Read These Instructions



**Warning!** Read and follow all warning notices and instructions marked on the product or included in the documentation.

**Avertissement!** Lisez et conformez-vous à tous les avis et instructions d'avertissement indiqués sur le produit ou dans la documentation.

**Warnung!** Lesen und befolgen Sie die Warnhinweise und Anweisungen, die auf dem Produkt angebracht oder in der Dokumentation enthalten sind.

**¡Advertencia!** Lea y siga todas las instrucciones y advertencias marcadas en el producto o incluidas en la documentación.

**Aviso!** Leia e siga todos os avisos e instruções assinalados no produto ou incluídos na documentação.

**Avviso!** Leggere e seguire tutti gli avvisi e le istruzioni presenti sul prodotto o inclusi nella documentazione.



**Warning!** Do not use this device near water and clean only with a dry cloth.

**Avertissement!** N'utilisez pas cet appareil près de l'eau et nettoyez-le seulement avec un tissu sec.

**Warnung!** Das Gerät nicht in der Nähe von Wasser verwenden und nur mit einem trockenen Tuch säubern.

**¡Advertencia!** No utilice este dispositivo cerca del agua y límpielo solamente con un paño seco.

**Aviso!** Não utilize este dispositivo perto da água e limpe-o somente com um pano seco.

**Avviso!** Non utilizzare questo dispositivo vicino all'acqua e pulirlo soltanto con un panno asciutto.



**Warning!** Do not block any ventilation openings. Install in accordance with the manufacturer's instructions.

**Avertissement!** Ne bloquez aucune ouverture de ventilation. Suivez les instructions du fabricant lors de l'installation.

**Warnung!** Die Lüftungsöffnungen dürfen nicht blockiert werden. Nur gemäß den Anweisungen des Herstellers installieren.

**¡Advertencia!** No bloquee ninguna de las aberturas de la ventilación. Instale de acuerdo con las instrucciones del fabricante.

**Aviso!** Não obstrua nenhuma das aberturas de ventilação. Instale de acordo com as instruções do fabricante.

**Avviso!** Non ostruire le aperture di ventilazione. Installare in conformità con le istruzioni del fornitore.



**Warning!** Do not install near any heat sources such as radiators, heat registers, stoves, or other apparatus (including amplifiers) that produce heat.

**Avertissement!** N'installez pas l'appareil près d'une source de chaleur telle que des radiateurs, des bouches d'air de chauffage, des fourneaux ou d'autres appareils (amplificateurs compris) qui produisent de la chaleur.

**Warnung!** Nicht in der Nähe von Wärmequellen wie Heizkörpern, Heizregistern, Öfen oder anderen Wärme erzeugenden Geräten (einschließlich Verstärkern) aufstellen.

**¡Advertencia!** No instale cerca de fuentes de calor tales como radiadores, registros de calor, estufas u otros aparatos (incluidos amplificadores) que generan calor.

**Aviso!** Não instale perto de nenhuma fonte de calor tal como radiadores, saídas de calor, fogões ou outros aparelhos (incluindo amplificadores) que produzam calor.

**Avviso!** Non installare vicino a fonti di calore come termosifoni, diffusori di aria calda, stufe o altri apparecchi (amplificatori compresi) che emettono calore.



**Warning!** Unplug this device during lightning storms or when unused for long periods of time.

**Avertissement!** Débranchez cet appareil pendant les orages avec éclairs ou s'il est inutilisé pendant de longues périodes.

**Warnung!** Das Gerät ist bei Gewitterstürmen oder wenn es über lange Zeiträume ungenutzt bleibt vom Netz zu trennen.

**¡Advertencia!** Desenchufe este dispositivo durante tormentas eléctricas o cuando no se lo utilice por largos periodos del tiempo.

**Aviso!** Desconecte este dispositivo da tomada durante trovoadas ou quando não é utilizado durante longos períodos de tempo.

**Avviso!** Utilizzare soltanto i collegamenti e gli accessori specificati e/o venduti dal produttore, quali il treppiedi e l'esoscheletro.



**Warning!** Only use attachments and accessories specified and/or sold by the manufacturer.

**Avertissement!** Utilisez seulement les attaches et accessoires spécifiés et/ou vendus par le fabricant.

**Warnung!** Verwenden Sie nur Zusatzgeräte und Zubehör angegeben und / oder verkauft wurde durch den Hersteller.

**¡Advertencia!** Utilice solamente los accesorios y conexiones especificados y/o vendidos por el fabricante.

**Aviso!** Utilize apenas equipamentos/acessórios especificados e/ou vendidos pelo fabricante.

**Avviso!** Utilizzare soltanto i collegamenti e gli accessori specificati e/o venduti dal produttore.



**Warning!** Refer all servicing to qualified service personnel. Servicing is required when the device has been damaged in any way, such as power-supply cord or plug is damaged, liquid has been spilled or objects have fallen into the device, the device has been exposed to rain or moisture, does not operate normally, or has been dropped.

**Avertissement!** Référez-vous au personnel de service qualifié pour tout entretien. L'entretien est exigé quand l'appareil a été endommagé de quelque manière que ce soit, par exemple lorsque le cordon d'alimentation ou la prise sont endommagés, que du liquide a été versé ou des objets sont tombés dans l'appareil, que l'appareil a été exposé à la pluie ou à l'humidité, ne fonctionne pas normalement ou est tombé.

**Warnung!** Das Gerät sollte nur von qualifizierten Fachkräften gewartet werden. Eine Wartung ist fällig, wenn das Gerät in irgendeiner Weise beschädigt wurde, wie bei beschädigtem Netzkabel oder Netzstecker, falls Flüssigkeiten oder Objekte in das Gerät gelangen, das Gerät Regen oder Feuchtigkeit ausgesetzt wurde, nicht ordnungsgemäß funktioniert oder fallen gelassen wurde.

**¡Advertencia!** Consulte al personal calificado por cuestiones de reparación. El servicio de reparación se requiere cuando el dispositivo ha recibido cualquier tipo de daño, por ejemplo cable o espigas dañadas, se ha derramado líquido o se han caído objetos dentro del dispositivo, el dispositivo ha sido expuesto a la lluvia o humedad, o no funciona de modo normal, o se ha caído.

**Aviso!** Remeta todos os serviços de manutenção para o pessoal de assistência qualificado. A prestação de serviços de manutenção é exigida quando o dispositivo foi danificado mediante qualquer forma, como um cabo de alimentação ou ficha que se encontra danificado/a, quando foi derramado líquido ou caíram objectos sobre o dispositivo, quando o dispositivo foi exposto à chuva ou à humidade, quando não funciona normalmente ou quando foi deixado cair.

**Avviso!** Fare riferimento al personale qualificato per tutti gli interventi di assistenza. L'assistenza è necessaria quando il dispositivo è stato danneggiato in qualche modo, ad esempio se il cavo di alimentazione o la spina sono danneggiati, è stato rovesciato del liquido è stato rovesciato o qualche oggetto è caduto nel dispositivo, il dispositivo è stato esposto a pioggia o umidità, non funziona correttamente o è caduto.



**Warning!** Do not defeat the safety purpose of the polarized or grounding-type plug. A polarized plug has two blades with one wider than the other. A grounding type plug has two blades and a third grounding prong. The wide blade or the third prong are provided for your safety. If the provided plug does not fit into your outlet, consult an electrician for replacement of the obsolete outlet.

**Avertissement!** La sécurité de la prise polarisée ou de la prise de type mise à la terre ne doit en aucun cas être empêchée de fonctionner. Une prise polarisée a deux broches, l'une étant plus large que l'autre. Une prise de type mise à la terre a deux broches et une troisième broche pour la mise à la terre. La broche large ou la troisième broche sont fournies pour votre sécurité. Si la prise fournie ne s'insère pas dans votre prise femelle, consultez un électricien pour le remplacement de la prise femelle obsolète.

**Warnung!** Der Sicherheitszweck des gepolten bzw. Schukosteckers ist zu berücksichtigen. Ein gepolter Stecker verfügt über zwei Pole, von denen einer breiter als der andere ist. Ein Schukostecker verfügt neben den zwei Polen noch über einen dritten Pol zur Erdung. Der breite Pol bzw. der Erdungspol dienen der Sicherheit. Wenn der zur Verfügung gestellte Stecker nicht in Ihren Anschluss passt, konsultieren Sie einen Elektriker, um den veralteten Anschluss zu ersetzen.

**¡Advertencia!** No eche por tierra la finalidad del tipo de enchufe polarizado con conexión a tierra. Un enchufe polarizado tiene dos espigas, una más ancha que la otra. Un enchufe con conexión a tierra tiene dos espigas iguales y una tercera espiga que sirve para la conexión a tierra. La espiga ancha, o la tercera espiga, sirven para su seguridad. Si el enchufe suministrado no encaja en el tomacorriente, consulte con un electricista para reemplazar el tomacorriente obsoleto.

**Aviso!** Não anule a finalidade da segurança da ficha polarizada ou do tipo ligação terra. Uma ficha polarizada tem duas lâminas sendo uma mais larga do que a outra. Uma ficha do tipo de ligação à terra tem duas lâminas e um terceiro terminal de ligação à terra. A lâmina larga ou o terceiro terminal são fornecidos para sua segurança. Se a ficha fornecida não couber na sua tomada, consulte um electricista para a substituição da tomada obsoleta.

**Avviso!** Non compromettere la sicurezza della spina polarizzata o con messa a terra. Una spina polarizzata ha due spinotti, di cui uno più largo. Una spina con messa a terra ha due spinotti e un terzo polo per la messa a terra. Lo spinotto largo o il terzo polo sono forniti per motivi di sicurezza. Se la spina fornita non si inserisce nella presa di corrente, contattare un elettricista per la sostituzione della presa obsoleta.



**Warning!** Since the Mains plug is used as the disconnection for the device, it must remain readily accessible and operable.

**Avertissement!** Puisque la prise principale est utilisée pour débrancher l'appareil, elle doit rester aisément accessible et fonctionnelle.

**Warnung!** Da der Netzstecker als Trennvorrichtung dient, muss er stets zugänglich und funktionsfähig sein.

**¡Advertencia!** Puesto que el enchufe de la red eléctrica se utiliza como dispositivo de desconexión, debe seguir siendo fácilmente accesible y operable.

**Aviso!** Dado que a ficha principal é utilizada como a desconexão para o dispositivo, esta deve manter-se prontamente acessível e funcional.

**Avviso!** Poiché il cavo di alimentazione viene usato come dispositivo di sconnessione, deve rimanere prontamente accessibile e operabile.



**Warning!** Protect the power cord from being walked on or pinched particularly at plugs, convenience receptacles, and the point where they exit from the device.

**Avertissement!** Protégez le cordon d'alimentation pour que l'on ne marche pas dessus ou qu'on le pince, en particulier au niveau des prises mâles, des réceptacles de convenance, et à l'endroit où il sort de l'appareil.

**Warnung!** Vermeiden Sie, dass auf das Netzkabel getreten oder das Kabel geknickt wird, insbesondere an den Steckern, den Steckdosen und am Kabelausgang am Gerät.

**¡Advertencia!** Proteja el cable de corriente para que no se le pise ni apriete, en especial cerca del enchufe, los receptáculos de conveniencia y el punto del que salen del equipo.

**Aviso!** Proteja o cabo de alimentação de ser pisado ou de ser comprimido particularmente nas fichas, em tomadas de parede de conveniência e no ponto de onde sai do dispositivo.

**Avviso!** Proteggere il cavo di alimentazione in modo che nessuno ci cammini sopra e che non venga schiacciato soprattutto in corrispondenza delle spine e del punto in cui esce dal dispositivo.



**Warning!** Disconnect the external AC power supply line cord(s) from the mains power before moving the unit.

**Avertissement!** Retirez le ou les cordons d'alimentation en CA de la source d'alimentation principale lorsque vous déplacez l'appareil.

**Warnung!** Trennen Sie die Wechselstrom-Versorgungskabel vom Netzstrom, bevor Sie das Gerät verschieben.

**¡Advertencia!** Cuando mueva la unidad desenchufe de la red eléctrica el/los cable(s) de la fuente de alimentación CA tipo brick.

**Advertência!** Remova os cabos CA de alimentação brick da rede elétrica ao mover a unidade.

**Avvertenza!** Scollegare il cavo dell'alimentatore quando si sposta l'unità.

# 3 Year Warranty and Liability Information

---

## Limited Warranty on Hardware

---

AJA Video Systems, Inc. (AJA Video) warrants that the hardware product, not including storage modules or software components, will be free from defects in materials and workmanship for a period of three years from the date of purchase. AJA Video warrants that the storage modules provided as part of the hardware product will be free from defects in materials and workmanship for a period of one year from the date of purchase. AJA Video provides a separate software warranty as part of the license agreement applicable to software components.

If the Customer brings a valid claim under this limited warranty for a hardware product or storage module (hereafter, a "product") during the applicable warranty period, AJA Video will, at its sole option and as the Customer's sole remedy for breach of the above warranty, provide one of the following remedies:

- Repair or facilitate the repair the product within a reasonable period of time, free of charge for parts and labor.
- Replace the product with a direct replacement or with a product that performs substantially the same function as the original product.
- Issue a refund of the original purchase price less depreciation to be determined based on the age of the product at the time remedy is sought under this limited warranty.

To obtain service under this warranty, the Customer must notify AJA Video of the defect before expiration of the warranty period and make suitable arrangements for the performance of service by contacting AJA Video support through the channels set forth on the support contacts web page at <https://www.aja.com/support>.

Except as stated, the Customer shall bear all shipping, packing, insurance and other costs, excluding parts and labor, to effectuate repair. Customer shall pack and ship the defective product to a service center designated by AJA Video, with shipping charges prepaid. AJA Video shall pay to return the product to Customer, but only if to a location within the country in which the AJA Video service center is located. SOME JURISDICTIONS DO NOT ALLOW THE EXCLUSION OF IMPLIED WARRANTIES OR LIMITATIONS ON APPLICABLE STATUTORY RIGHTS OF A CONSUMER, SO SOME OR ALL OF THE TERMS OF THIS PARAGRAPH MAY NOT APPLY TO YOU.

## Limitation of Liability

---

Under no circumstances shall AJA video BE LIABLE IN ANY WAY FOR ANY LOST, CORRUPTED OR DESTROYED DATA, FOOTAGE OR WORK, OR FOR ANY OTHER INDIRECT, SPECIAL, INCIDENTAL OR CONSEQUENTIAL DAMAGES OR LOST PROFITS, OR FOR ANY THIRD PARTY CLAIM, IN CONNECTION WITH THE PRODUCT, WHETHER RESULTING FROM DEFECTS IN THE PRODUCT, SOFTWARE OR HARDWARE FAILURE, OR ANY OTHER CAUSE WHATSOEVER, EVEN IF AJA VIDEO HAS BEEN ADVISED OF THE POSSIBILITY OF SUCH DAMAGES. AJA VIDEO'S LIABILITY IN CONNECTION WITH THE PRODUCT SHALL UNDER NO CIRCUMSTANCES EXCEED THE PURCHASE PRICE PAID FOR THE PRODUCT. The foregoing limitations apply even if any remedy set forth in this LIMITED WARRANTY fails of its essential purpose. SOME JURISDICTIONS DO NOT ALLOW THE LIMITATION OF LIABILITY FOR PERSONAL INJURY, OR OF INCIDENTAL OR CONSEQUENTIAL DAMAGES, SO SOME OR ALL OF THE TERMS OF THIS PARAGRAPH MAY NOT APPLY TO YOU.

## Governing Law and Language; Your Rights

---

This limited warranty is the only warranty provided by AJA Video on the hardware product. It supersedes all prior or contemporaneous understandings regarding such subject matter. No amendment to or modification of this warranty will be binding unless in writing and signed by AJA Video. The laws of the State of California, USA will govern this warranty and any dispute arising from it. Any translation of this Agreement is intended for convenience and to meet local requirements and in the event of a dispute between the English and any non-English versions, the English version of this warranty will govern. This limited warranty gives you specific legal rights and you may have other rights that vary from jurisdiction to jurisdiction, some of which are noted above.

# AJA Software License Agreement

---

AJA VIDEO SYSTEMS, INC.

THIS IS AN AGREEMENT BETWEEN YOU AND AJA VIDEO SYSTEMS, INC. ("AJA") THAT GOVERNS YOUR USE OF the software ACCOMPANYING THIS LICENSE (E.G., AS installed on the device with which this license is provided).

The "AJA Software" referenced in this Agreement includes all such software, whether made available to you on disk, in read only memory, on any other media or in any other form, and all updates, corrections, enhancements and new versions of such software made available by AJA, together with all related documentation. BY INSTALLING OR USING THE AJA SOFTWARE, YOU ARE AGREEING TO BE BOUND BY THE TERMS OF THIS AGREEMENT. IF YOU DO NOT AGREE TO THE TERMS OF THIS AGREEMENT, DO NOT INSTALL OR USE IT AND, IF APPLICABLE, RETURN THE AJA SOFTWARE TO THE PLACE WHERE YOU OBTAINED IT FOR A REFUND.

1. License Grant. AJA hereby grants you a nonexclusive, personal, non-sublicenseable and limited license to install and use AJA Software on a computer or AJA device. The foregoing license also includes the right to make copies of the AJA Software in machine-readable form for installation and backup purposes only, and provided that each copy you make must include all copyright or other proprietary notices contained on the original.

2. Limitations. You may not decompile, reverse engineer, disassemble, modify, or create derivative works of the AJA Software or any part thereof except to the extent (if any) authorized by applicable law notwithstanding the foregoing restriction. You may not rent, lease, lend, loan, distribute or act as a service bureau or "cloud service" provider with respect to use of the AJA Software or any functionality thereof. THE AJA SOFTWARE IS NOT INTENDED FOR USE IN THE OPERATION OF NUCLEAR FACILITIES, AIRCRAFT NAVIGATION OR COMMUNICATION SYSTEMS, AIR TRAFFIC CONTROL SYSTEMS, LIFE SUPPORT MACHINES OR OTHER EQUIPMENT IN WHICH THE FAILURE OF THE AJA SOFTWARE COULD LEAD TO DEATH, PERSONAL INJURY, OR SEVERE PHYSICAL OR ENVIRONMENTAL DAMAGE.

3. Reservation of Rights. The AJA Software is protected by law, including without limitation copyright law. The AJA Software is licensed, not sold, to you. AJA and its licensors reserve all rights not expressly granted to you by this Agreement. You own the media on which the AJA Software is recorded but AJA and/or AJA's licensor(s) retain ownership of the AJA Software itself. You may not use the AJA Software for any illegal purpose.

4. Transfer. You may make a one-time permanent transfer of all of your license rights to the AJA Software to another person or entity, provided that: (a) you transfer all of the AJA Software, including all its component parts, original media, printed materials and this Agreement; (b) you do not retain any copies of the AJA Software, including any copies stored on a computer or other device; and (c) you transfer the AJA Software subject to this Agreement, and the person or entity receiving the AJA Software accepts the terms and conditions of this Agreement.

5. NFR (Not for Resale) Copies and Add-On Features: Notwithstanding anything to the contrary in this Agreement, (a) AJA Software that is labeled "Not for Resale" or otherwise provided to you on a promotional or demonstration basis may be used only for your demonstration, testing and evaluation purposes and may not be resold or transferred; and (b) AJA may make available certain software components ("Add-On Features") under separate terms and conditions, in which case those separate terms and conditions apply and the Add-On Features are not considered AJA Software under this Agreement.

6. Termination. Your rights in the AJA Software are conditioned on complying with this Agreement, and those rights (together with this Agreement) will terminate automatically, without notice from AJA, if you fail to comply with any term(s) of this Agreement. Upon termination of this Agreement, you must cease all use of the AJA Software and destroy all copies, full or partial, of the AJA Software in your possession or control.

7. Limited Warranty on AJA Software. If you comply with all terms of this Agreement and use the AJA Software in accordance with its documentation, and you install any patches or other updates made available to the AJA Software by AJA, AJA warrants that the AJA Software will perform substantially in accordance with its documentation for a period of ninety (90) days from the date of your original retail purchase. Your exclusive remedy under this warranty will be, at AJA's option, a refund of the purchase

price of the product containing the AJA Software or an update to or replacement of the AJA Software (or applicable component of it). THIS LIMITED WARRANTY AND ANY IMPLIED WARRANTIES ON THE AJA SOFTWARE INCLUDING, BUT NOT LIMITED TO, ANY WARRANTIES OF MERCHANTABILITY, OF SATISFACTORY QUALITY, OR OF FITNESS FOR A PARTICULAR PURPOSE, ARE LIMITED IN DURATION TO NINETY (90) DAYS FROM THE DATE OF ORIGINAL RETAIL PURCHASE. SOME JURISDICTIONS DO NOT ALLOW LIMITATIONS ON HOW LONG A WARRANTY LASTS, SO THE ABOVE LIMITATION MAY NOT APPLY TO YOU. THIS LIMITED WARRANTY GIVES YOU SPECIFIC LEGAL RIGHTS, AND YOU MAY ALSO HAVE OTHER RIGHTS WHICH VARY BY JURISDICTION.

8. Disclaimer of Other Warranties on Aja Software. EXCEPT FOR THE LIMITED WARRANTY ON AJA SOFTWARE SET FORTH ABOVE, AJA AND AJA'S LICENSORS (COLLECTIVELY REFERRED TO AS "AJA" FOR THE PURPOSES OF SECTIONS 8 AND 9) HEREBY DISCLAIM ALL WARRANTIES AND CONDITIONS WITH RESPECT TO THE AJA SOFTWARE, WHETHER EXPRESS, IMPLIED OR STATUTORY, INCLUDING, BUT NOT LIMITED TO, THE IMPLIED WARRANTIES AND/OR CONDITIONS OF MERCHANTABILITY, OF SATISFACTORY QUALITY, OF FITNESS FOR A PARTICULAR PURPOSE, OF ACCURACY, AND OF QUIET ENJOYMENT. FURTHER, AJA DOES NOT MAKE ANY WARRANTY REGARDING NON-INFRINGEMENT OF THIRD PARTY RIGHTS. SUBJECT ONLY TO THE LIMITED WARRANTY SET FORTH IN SECTION 7, YOU EXPRESSLY ACKNOWLEDGE AND AGREE THAT USE OF THE AJA SOFTWARE IS AT YOUR SOLE RISK. AJA DOES NOT WARRANT AGAINST INTERFERENCE WITH YOUR ENJOYMENT OF THE AJA SOFTWARE, THAT THE AJA SOFTWARE WILL MEET YOUR REQUIREMENTS, THAT THE OPERATION OF THE AJA SOFTWARE WILL BE UNINTERRUPTED OR ERROR-FREE, OR THAT DEFECTS IN THE AJA SOFTWARE WILL BE CORRECTED. NO ORAL OR WRITTEN INFORMATION OR ADVICE GIVEN BY AJA OR AN AJA AUTHORIZED REPRESENTATIVE WILL CREATE A WARRANTY. SOME JURISDICTIONS DO NOT ALLOW THE EXCLUSION OF IMPLIED WARRANTIES OR LIMITATIONS ON APPLICABLE STATUTORY RIGHTS OF A CONSUMER, SO SOME OR ALL OF THE TERMS OF THIS PARAGRAPH MAY NOT APPLY TO YOU.

9. Limitation of Liability. TO THE EXTENT NOT PROHIBITED BY LAW, IN NO EVENT WILL AJA BE LIABLE FOR PERSONAL INJURY, OR ANY INCIDENTAL, SPECIAL, INDIRECT OR CONSEQUENTIAL DAMAGES OR LOST PROFITS WHATSOEVER, INCLUDING, WITHOUT LIMITATION, DAMAGES FOR LOSS OF DATA, BUSINESS INTERRUPTION OR ANY OTHER COMMERCIAL DAMAGES OR LOSSES, ARISING OUT OF OR RELATED TO YOUR USE OR INABILITY TO USE THE AJA SOFTWARE, HOWEVER CAUSED, REGARDLESS OF THE THEORY OF LIABILITY (E.G., WHETHER UNDER CONTRACT, TORT OR OTHERWISE) AND EVEN IF AJA HAS BEEN ADVISED OF THE POSSIBILITY OF SUCH DAMAGES. In no event will AJA's total liability to you for all damages (INCLUDING WITHOUT LIMITATION BREACH OF WARRANTY) exceed the amount of fifty dollars (\$50.00). The foregoing limitations will apply even if the any remedy set forth in this agreement fails of its essential purpose. SOME JURISDICTIONS DO NOT ALLOW THE LIMITATION OF LIABILITY FOR PERSONAL INJURY, OR OF INCIDENTAL OR CONSEQUENTIAL DAMAGES, SO SOME OR ALL OF THE TERMS OF THIS PARAGRAPH MAY NOT APPLY TO YOU.

10. Export Law Assurances. You may not use or otherwise export or reexport the AJA Software except as authorized by United States law and the laws of the jurisdiction in which the AJA Software was obtained. In particular, but without limitation, the AJA Software may not be exported or re-exported (a) into (or to a national or resident of) any U.S. embargoed countries, or (b) to anyone on the U.S. Treasury Department's list of Specially Designated Nationals or the U.S. Department of Commerce Denied Persons List or Entity List or any similar legal designation. By using the AJA Software, you represent and warrant that you are not located in, under control of, or a national or resident of any such country or on any such list.

11. Government End Users. The AJA Software including its documentation is a "Commercial Item", as that term is defined at 48 C.F.R. § 2.101, consisting of "Commercial Computer Software" and "Commercial Computer Software Documentation", as such terms are used in 48 C.F.R. § 12.212 or 48 C.F.R. § 227.7202 (or their successors), as applicable. Consistent with these provisions, the AJA Software is licensed to U.S. Government end users (a) only as a Commercial Item and (b) with only those rights as are granted to all other end users pursuant to this Agreement. Unpublished-rights reserved under the copyright laws of the United States.

12. Controlling Law and Severability. This Agreement will be governed by and construed in accordance with the laws of the State of California, as applied to agreements entered into and to be performed entirely within California between California residents. This Agreement will not be governed by the United Nations

Convention on Contracts for the International Sale of Goods, the application of which is expressly excluded. If for any reason a court of competent jurisdiction finds any provision, or portion thereof, to be unenforceable, the remainder of this Agreement will continue in full force and effect.

13. Complete Agreement; Governing Language. This Agreement constitutes the entire agreement between the parties with respect to the use of the AJA Software licensed hereunder and supersedes all prior or contemporaneous understandings regarding such subject matter. No amendment to or modification of this Agreement will be binding unless in writing and signed by AJA. Any translation of this Agreement is intended for convenience and to meet local requirements and in the event of a dispute between the English and any non-English versions, the English version of this Agreement will govern.

# Index

---

## Symbols

- 2SI Alignment 28
- 3G Transport 33
- 3rd-Party Plugins 9

## A

- About RGB and YCbCr (YUV) Video 30, 55
- Additional with Mac and Windows Packages 9
- AJA Agent is not running 24
  - Restart Services 24
- AJA Control Panel 9
- AJA Control Panel Operating Modes 20
- AJA Control Panel Restart Services 24
- AJA Control Panel User Interface 10, 20
- AJA Control Room 9, 56
- AJA Device Format 29
- AJA Software License Agreement 79
- AJA Software & Utilities 8
- AJA Support 2
- AJA System Test 9
- Analog Audio Cable Harness (Optional) 60
- Analog Black 39
- Application
  - Controlling KONA 23
- Application Compatibility 6
- ATX Power 13
- Audio Ch 34
- Audio Configure 40
- Audio Input 31
- Audio Mixer Capture Monitor Mode Screen 42
- Audio Mixer Playback Monitor Mode Screen 43
- Audio Monitoring 14
- Audio Monitoring Routing Diagram 15
- Audio Out 46
- Audio Setup 40
- Audio Setup Screen 40

## B

- Before Operation Please Read 74
- Block Diagram Area 21
- BMP Format 7

## C

- Cable Connections 7
- Cables between KONA Xpand and KONA X 61
- Cabling the System 14
- Capture Formats 7
- Capture Mode 20

- Ch Map 32
- Colorimetry 36
- Color Space 32, 33, 35, 39
- Connect Cables to KONA X Card 62
- Connect Cables to KONA Xpand Card 63
- Controlling Application 23
- Controlling Application Format Selection 23
- Control Panel 9, 20
  - Block Diagram Area 21
  - Framebuffer 22
  - Input/Output Icon 22
  - UI Colors 22
  - User Interface 20
- Control Panel Restart Services 24
- Control Room Operating Modes 57
- Control Room Overview 56
- Control Room Screen Layout 56, 57
- Control Room User Interface 56
- Control Screen 27
- Conversion Screen 30
- Converted Format 23
- Custom LUT Controls 49

## D

- Damage in Shipping 11
- Default State 27
- Delay In/Out 40
- Device Format 23
- Digital Cable Harness (Multi IO) 59
- Digital Primaries 37
- Disk Storage Methods 10
- Display Mastering Luminance 37
- Downstream Keyer 7, 45
- Downstream Keyer Modes 45
- DPX Format 7
- Drivers 9
- Downstream Keyer Screen 45

## E

- Erase All Prefs 53
- Export 50

## F

- Features
  - KONA 5 7
- Firmware Screen 54
- Firmware Update Procedure 17
- Follow Input 30
- Foreground Pre-Multiplied 46
- Format Screen 29
- Framebuffer
  - Control Panel UI 22
- Freerun 29
- Function Screens 25

## G

- Gain and Offset
  - Reset 50
- Gamma 39
- Genlock Source 28
- Graphic File Display 28
- Graphic File Load 47

## H

- HDMI Input 35
- HDMI Output 34
- HDMI Screen 34
- HDR Capture 36
- HDR Mode 38
- HDR Screen 36
- Hold Last App 28
- Horiz and Vert Timing 29

## I

- Info Screen 55
- Input/Output Icon 22
- Input/Output Icons 22
- Input Select Screen 30
  - UFC Mode 30
- Installation
  - KONA Card 12
- Installation Overview 11
- Installing Software 16
- Installing Software 8
- Installing the KONA X Card 12
- Install Xpand Card into Chassis 64
- Internal HD/SD Hardware 7

## K

- Keying Mode Examples 46
- KONA 4 Cables 11
- KONA 5 ATX Power 13
- KONA 5 Features 7
- KONA Card
  - Installation 12
- KONA X Card 6
- KONA X Example Cable Connections 14
- KONA X Key Connectivity 6
- KONA X Key Features 5
- KONA Xpand Card 58
- KONA Xpand Card & Cable Options 58
- KONA Xpand Card Cable Options 59
- KONA Xpand Card features 59
- KONA Xpand Card Installation 62
- KONA Xpand Example System Connections 65
- KONA Xpand Installation 62
- KONA Xpand Key Features 6

## L

- LTC/Ref 60
- Luminance 37
- LUT File 50
- LUT File Format Specification 51
- LUT Gain and Offset Controls 50
- LUT Screen 48
- LUT Type 49

## M

- macOS Installations 8, 16
- Mac, Windows and Linux Packages 9
- Matte Color 46
- Matte Color Selection 47
- Maximum Content Light Level (CLL) 38
- Maximum Frame Average Light Level (FALL) 38
- Modes of Operation 20
- MOV Format 7
- Multiple AJA Devices 26
- Multiple AJA Products 26
- MXF Format 7

## N

- Notes on Using Multiple AJA Products 27
- Installing the KONA X Card 12

## O

- Opacity 46
- Operating Modes 20
- Operation 64
- Output Options 32
- Overview 5, 6

## P

- Pass Through (Cap) 27
- Pixel Format 30
- Playback Mode 20
- Playback Source Selection 43
- Preferences 24
- Preference Settings 53
- Prepare to Install 62
- Preset
  - Loading 53
  - Reset to Default 53
  - Saving 53
  - Transferring 53
- Presets 24
- Presets Screen 52
- Progressive Pref 39
- Protocol 34

## Q

- QuickTime Format 7

## R

- Ref In 29
- Reset
  - Gain and Offset 50
- Restart Services
  - Control Panel 24
- RGB Range 30, 33, 35

## S

- Safety & Compliance 71
- SDI Color Sp 31
- SDI Output Screen 32
- SDI RGB Rng 31
- Shared Preference 25
  - File Location 25
- Shipping Box Contents 11
- Single-User & Shared Preferences 24
- Software 8
- Software Download 16
- Software Installation 16
- Software Package Installation and Re-installation 16
- Source 34, 35
  - Video Input 31
- Supported Features 6
- System Requirements 10
- System Test 9

## T

- Test Pattern 28
- TGA Format 7
- Third-Party Application 16
- Third Party Software Support 11
- Thunderbolt PCIe External Chassis 12, 62
- Timecode Screen 51
- Timecode Source 52
- Timing
  - Horiz 29
  - Vert 29
- Transferring Saved Presets 53
- Typical KONA X System Connections 14, 65

## U

- Audio Mixer Screens 41
- Unpacking 11
- Uploading Custom User LUT file 50
- User Bits 52
- User Preference 25
  - File Location 25
- Using Multiple AJA Products 26
- Using the Downstream Keyer 46
- Utilities 8

## V

- VANC Checkbox 39
- Video In 29
- Video Input 31
- Video Setup 39

Video Setup Screen 38

## X

Xpand Operation 64