

Io X3

Capture, Display, Convert



Installation and Operation Manual

Version 18.0
Published April 01, 2026



Notices

Trademarks

AJA® and Because it matters.® are registered trademarks of AJA Video Systems, Inc. for use with most AJA products. AJA™ is a trademark of AJA Video Systems, Inc. for use with recorder, router, software and camera products. Because it matters.™ is a trademark of AJA Video Systems, Inc. for use with camera products.

Corvid Ultra®, Io®, Ki Pro®, KONA®, KUMO®, ROI® and T-Tap® are registered trademarks of AJA Video Systems, Inc.

AJA Control Room™, KiStor™, Science of the Beautiful™, TruScale™, V2Analog™ and V2Digital™ are trademarks of AJA Video Systems, Inc.

All other trademarks are the property of their respective owners.

Copyright

Copyright © 2026 AJA Video Systems, Inc. All rights reserved. All information in this manual is subject to change without notice. No part of the document may be reproduced or transmitted in any form, or by any means, electronic or mechanical, including photocopying or recording, without the express written permission of AJA Video Systems, Inc.

Contacting AJA Technical Support or Sales

Please have all pertinent information at hand prior to contacting AJA support or sales.

Support Telephone: +1-530-271-3190

Support Website: <https://www.aja.com/support/contact>

Support Email: support@aja.com

Sales Email: sales@aja.com

Shipping Address: AJA Video Systems
180 Litton Drive
Grass Valley, CA 95945, USA

Contents

Notices	2
Trademarks	2
Copyright	2
Contacting AJA Technical Support or Sales	2
Chapter 1 – Introduction	5
Overview	5
Features	5
Video Formats	6
Io X3 Audio	6
AJA Software & Utilities	6
System Requirements	7
What's In The Box?	7
In This Manual	7
Chapter 2 – Installation	9
Installation Overview	9
Cable Connections	9
Connector Descriptions	9
Installing Software	11
macOS Installations	11
macOS, Windows and Linux Packages	12
Additional with Mac and Windows Packages	12
Chapter 3 – Io X3 Operation	13
Front Panel Operation	13
Monitor Output and Gain Control	13
Audio Level Meters	13
Status LED	14
AJA Control Panel Overview	14
AJA Control Panel Operating Modes	14
AJA Control Panel User Interface	14
Controlling Application	17
Presets	18
Default Preferences	18
Function Screens	19
Io X3 Audio Monitoring	20
AJA Control Panel Function Screens	22
Control Screen	22
Format Screen	24
Input Select Screen	25
SDI Output Screen	27
HDMI Screen	29
HDR Screens	31
Video Setup Screen	34
Audio Setup Screen	35
Audio Mixer Screens	36
Audio Mixer Capture Monitor Mode Screen	38
Audio Mixer Playback Monitor Mode Screen	39
DS Keyer Screen	41
LUT Screen	43
Timecode Screen	46
Presets Screen	47
Firmware Screen	49
Info Screen	50
Appendix A – Specifications	51
Io X3 Tech Specs	51

Appendix B – Safety and Compliance54
3 Year Warranty and Liability Information62
AJA Software License Agreement63
Index.66

Chapter 1 – Introduction



Overview

AJA io X3 is perfect for high quality HDR or SDR work with HD/2K signals or files up to 60p. Connecting with a single Thunderbolt 3 cable and providing a second Thunderbolt connector for flexibility, io X3's compact and quiet form factor is ideal for on set, in the studio, at an event or in the edit suite.

For Editorial, VFX, Grading, Mastering and Graphic workflows, io X3 enables input, output and monitoring for both single and dual-link SDI sources and destinations, plus a dedicated reference connector and RS 422 serial interface.

For Audio Workflows io X3 supports 16 channels of embedded audio per SDI channel, 8 channels of embedded audio per HDMI channel, 8 channels of Analog Audio Input or Output (or 4 in plus 4 out), stereo headphone connector and discrete LTC Input and Output connectors.

For Switching and Streaming workflows io X3 simultaneously provides up to 4 channels for Input, and a single channel for Output, plus a MultiView feature that enables viewing up to four SDI input sources via HDMI out (when the application Program Out is not assigned).

Features

- Two Thunderbolt 3 ports
- Four bidirectional SDI BNCs configurable for up to four inputs, or four outputs, or two inputs and two outputs.
- Dual Link I/O for 1.5G-SDI and 3G-SDI (2 x BNC)
- Quad Link I/O for 1.5G-SDI, 3G-SDI (4 x BNC)
- HDMI 1.4b (using HDMI 2.0 implementation)
- VPID signaling for SDR/HDR Transfer Characteristics, Colorimetry and Luminance via SDI
- PQ, HLG and HDR10 Supported
- MultiView feature, able to display up to four io X3 SDI video inputs on a single HDMI UltraHD capable output monitor.
- Eight-channel Embedded HDMI audio
- Choice of Eight-Channel In, Eight-Channel Out, or Four-Channel In/Out analog audio (DB25 cable, Line Level)
- Front panel LED VU meters and Headphone output w/level control
- Dedicated Reference In BNC
- Individual LTC Input and Output BNCs
- RS-422 control via 9-pin
- Rugged Chassis, Small Size

- 12V DC, 4-pin XLR Power (AC adapter included)

Video Formats

For a list of supported video formats, see "[Appendix A Specifications](#)" on page 51.

Io X3 Audio

Io X3 provides up to 16 channels of SDI embedded audio, and up to eight channels of embedded HDMI audio. Eight channels of analog audio I/O is supported via a DB25 industry standard Tascam style audio breakout cable. The eight analog audio channels can be configured as either Ch 1-8 input, Ch 1-8 output, Ch1-4 input with Ch 5-8 output or, Ch 1-4 output with Ch 5-8 input.

AJA Software & Utilities

Io X3 operates with AJA's Desktop software package, developed for powerful integrated video/audio capture, editing, and production with a variety of third party software. AJA software is distributed as a unified package which includes all the software, firmware, plugins, and utility programs for the Io X3, as well as AJA's Io, KONA, and T-TAP products.

Four retail packages are available, one for macOS, one for Windows, and two for Linux (Ubuntu and Rocky).

NOTE: As of AJA Desktop software release v17.6, there is official support for AJA Thunderbolt I/O devices for Linux Ubuntu and Rocky Linux. See release notes for more information.

Mac, Windows, and Linux Packages

These packages include:

Drivers

AJA device drivers for tightly integrated hardware/software operation.

AJA Control Panel

The Control Panel provides:

- Source selection and control of your AJA hardware.
- A block diagram to show visually what routing and processing is being performed.

AJA Control Room

Control Room is a cross-platform software application for capture, playback and output with AJA products.

AJA System Test

AJA System Test is a utility for measuring system performance. The application includes:

- System Disk Test
- AJA Device Test
- System Report

The application tests Read and Write, Capture and Playback speeds tests in both Megabytes per second and Frames per second. The disk speed tests differ from standard disk I/O performance applications in that they specifically test the system under conditions typically encountered with video capture, playback, and editing.

NOTE: One way to test storage performance is to fill the target disk to 80% and then test capture at the highest data rate you will use. This may not be practical in all use cases.

Third Party Plugins

Plugins for popular third party Professional Video Applications from Adobe, Avid, Apple, OBS, Telestream, and others.

System Requirements

NOTE: On macOS, as of the publish date of this manual, the lo X3 supports Apple silicon processors as well as earlier Intel processors. Please refer to release notes for the AJA Desktop Software for the latest OS support information.

AJA Video recommends that your system meet minimum hardware and software requirements to achieve a satisfactory level of performance. Updates to system requirements are subject to change.

See the Release Notes for your AJA Card or Device, available on the AJA website and also installed with the software package, for minimum and recommended system requirements including OS, CPU, RAM, and GPU.

NOTE: Also see Software Vendor system requirements for GPU recommendations and additional hardware requirements and recommendations.

NOTE: For large scale installations with shared storage, IP, or for very high performance requirements, AJA recommends consultation with an experienced system integrator. A consultant will be able to assist with many important variables.

What's In The Box?

As you unpack the shipping box, carefully examine the contents. Ensure you received everything and that nothing was damaged during shipment.

If you find any damage, immediately notify the shipping service and supply them with a complete description of the damage, and contact your dealer or distributor for details on how to have your lo X3 repaired or replaced.

Save packing materials and the shipping box for future use should you need to transport your system or return it for service.

Inside the box you'll find the following components:

- lo X3
- 12V power adapter and power cord

In This Manual

Chapter 1 - Introduces the product briefly, listing features and system requirements.

Chapter 2 - Provides complete instructions for installing and configuring the product.

Chapter 3 - Discusses operational aspects and how to work with third party software.

Appendix A - Presents a list of technical specifications for the product.

Appendix B - Provides important Safety and Compliance information.

Chapter 2 – Installation

Installation Overview

1. If not previously installed on your Thunderbolt equipped computer, ensure that appropriate third party application software is installed as detailed in its user documentation.
2. Download and install the latest Io X3 software from:
<https://www.aja.com/support>
3. Connect your Io X3 to your computer using an appropriate Thunderbolt cable.
4. Connect the video and audio inputs and outputs.
5. Power up the unit (AC supply or battery). The Io X3 will startup automatically.
6. AJA recommends that you now run AJA Control Panel, as this allows you to verify that the installation has completed successfully.

NOTE: AJA Control Panel will prompt you to update firmware (if the new software package contained a firmware update for your AJA device).

Cable Connections

Figure 1. Io X3 Connectors

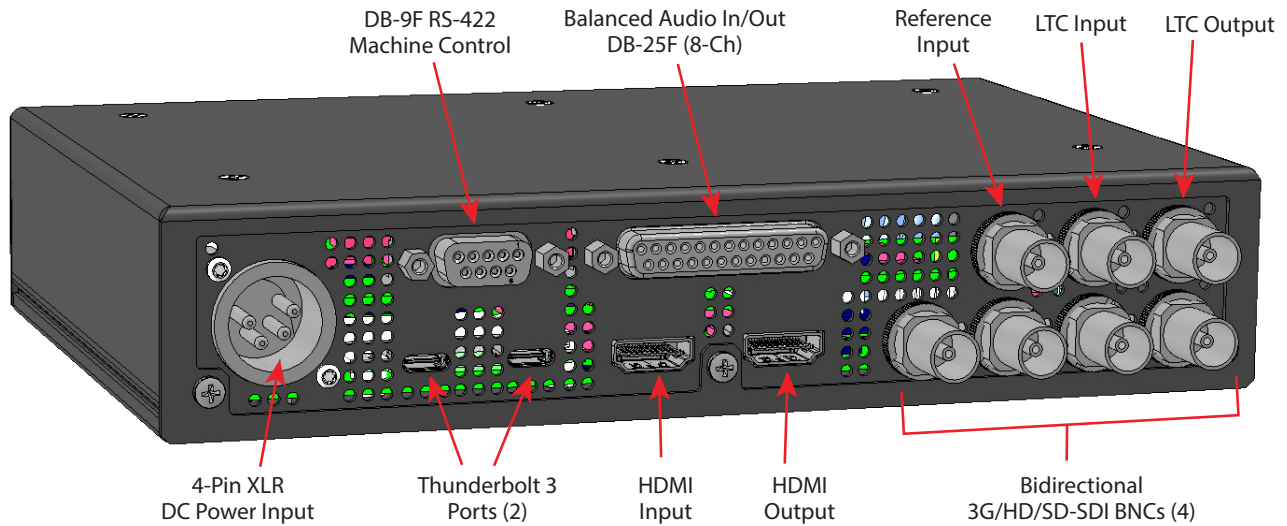

Connector Descriptions

Thunderbolt 3

The Io X3 provides the third-generation Thunderbolt 3 (USB-C) ports to support increased bandwidth between host computer and I/O device. Two ports are provided for daisy-chained network configurations.

The left port with the special logo is meant to identify the downstream Thunderbolt 3 port. The port on the right with the standard logo is meant to indicate the upstream port that is to be connected to the host computer. Despite a regulatory need to label one of these ports as downstream, the lo X3 actually has a fully symmetric Thunderbolt implementation. Either port can be used for either an upstream or downstream connection.

NOTE: lo X3 does not support host computer charging through the standard logo 'upstream' Thunderbolt port.

Bidirectional SDI I/O

Four bidirectional BNC connectors can be configured in a variety of ways via the AJA Control Panel, including:

- Two HD/SD inputs (SDI 1 and SDI 2) and two outputs (SDI 3 and SDI 4)
- Four HD/SD inputs (SDI 1, SDI 2, SDI 3, SDI 4)

NOTE: Some third party applications (examples: OBS Studio, Wirecast, Vmix) may support other input/output configurations. Please see the relevant AJA Quick Start Guide document for the application you are using.

HDMI Input and Output

Two HDMI connectors provide input and output of HDMI video and multi-channel embedded audio.

- HDMI 1.4b input and output (using HDMI 2.0 implementation) supporting resolutions at up to 60p (4:2:2), 10-bit
- Supports two or eight channel HDMI audio input and output

HDMI output also supports:

- HDR 10 Support - HDR Infoframe metadata, compatible with HDMI 2.0a/CTA-861.3
- HLG Support - compatible with HDMI 2.0b/CTA-861-G

NOTE: HDCP is not supported on either input or output. HDMI output does not have HDCP, and input sources having HDCP are not supported.

The HDMI input is designed to support long cable runs—up to 100 ft. when using 22 or 24AWG HDMI cable, or up to 50 ft. using 28 or 30AWG HDMI cable. The HDMI output supports standard HDMI cables only.

RS-422 Machine Control

A female DB-9 connector provides connection for VTRs, camcorders, disk media servers, and other devices using RS-422 SMPTE (Sony) protocol.

Reference Video

A dedicated BNC connector provides reference Input. Supplying a reference signal to the Reference input allows you to synchronize lo X3 outputs to your house analog reference video signal (or black burst). When connecting a reference video source, the locking signal should be the same as the input format. It is possible in some circumstances to use an alternate format video signal as long as the basic frame rate is compatible.

LTC Input and Output

Two BNC connectors provide dedicated LTC input and output.

Balanced Analog Audio Input and Output

A 25-pin connector provides 8-channel balanced analog audio, 24-bit 48kHz sample rate D/A and A/D. This will require an industry standard 8x XLR on DB-25 breakout cable (not supplied). The eight analog audio channels can be configured four different ways:

- Ch 1-8 Output
- Ch 1-4 Input and Ch 5-8 Output (default)
- Ch 1-4 Output and Ch 5-8 Input
- Ch 1-8 Input

12V Power Connector

A standard 4-pin XLR type connector is provided for either battery or line source power using the supplied AC power adapter.

Installing Software

NOTE: If your computer has previously had another video capture or multimedia device installed, ensure you uninstall any related software before installing Io X3. This will help prevent hardware or software conflicts.

Before installing the software package, ensure that your capture/editing application is installed as detailed in its user documentation. Before using Io X3 with an NLE application, it is best practice to have installed and run the software at least once on your workstation. Next, install the AJA software package.

If at a later date you add any Io X3 supported applications that require drivers, you must run the AJA install program again to install them.

macOS Installations

If you're reading this Io X3 manual without having downloaded an Desktop Software Installer package in order to open it, then go to the AJA website and download the **AJA Desktop Software v18.0 Installer**. This includes a package of all the current software for AJA's KONA, Io, and Io X3 products, including the AJA Control Panel and AJA Control Room applications, as well as the AJA manuals (product user guides) for all of the products that this AJA Desktop Software v18 Release supports.

System software updates may occasionally become available on our website (www.aja.com). We recommend checking occasionally for both software updates and additional product information.

NOTE: If your computer has previously had another video capture or multimedia device installed, ensure you uninstall any related software before installing the AJA software package. This will prevent any hardware or software conflicts.

IMPORTANT: Before installing the AJA software installer package, ensure that your editing application is installed as detailed in its user documentation. You cannot use Io X3 with a third-party application until the application has been installed and run at least once on your workstation. Next, install the AJA software package.

The products covered in this manual are compatible with Apple systems running macOS versions spanning several generations.

Note that different macOS versions will present specific dialogs during the installation process depending on the version and the specific model of device the AJA Desktop drivers and tools are being installed onto.

IMPORTANT: As of Desktop Software Installer v18.0, before you run the Installer, and regardless of previous software installations, all users must first run the AJA UnInstaller that is provided in the v18.0 Desktop Software Installer zip. Failure to do so will result in the Desktop Software Installer aborting with an error message.

For full information on supported devices, versions and step by step software installation procedures, please refer to the **AJA Desktop macOS Installation guide**, available at the following location:

<https://www.aja.com/support/item/10171>

macOS, Windows and Linux Packages

These packages include:

Drivers

AJA device drivers for tightly integrated hardware/software operation.

AJA Control Panel

The Control Panel provides:

- Source selection and control of your AJA hardware
- A block diagram to show visually what routing and processing is being performed

AJA Control Room

Control Room is a cross-platform software application for ingest, playback and output with AJA devices.

AJA System Test

System Test provides accurate and detailed evaluations of drive and system performance statistics, allowing you to measure the capabilities of your system for recording and playing back various resolutions and codecs. The application includes:

- System Disk Test
- AJA Device Test
- System Report

The application tests Read and Write, Capture and Playback speeds in both Megabytes per second and Frames per second. The disk speed tests differ from standard disk I/O performance applications in that they specifically test the system under conditions typically encountered with video capture, playback, and editing.

NOTE: One way to test storage performance is to fill the target disk to 80% and then test capture at the highest data rate you will use. This may not be practical in all use cases.

Additional with Mac and Windows Packages

Third Party Plugins

AJA provided plugins for popular third party Professional Video Applications from Adobe, Avid, Apple, OBS, and Telestream.

Chapter 3 – Io X3 Operation

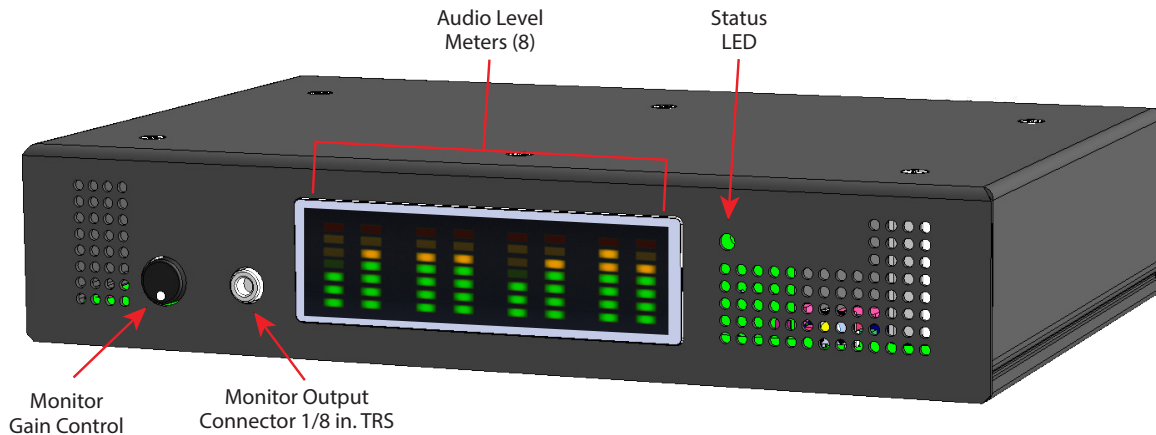

Front Panel Operation

The Io X3 front panel has the following controls and indicators:

Monitor Output and Gain Control

A 1/8 inch TRS connector is available for monitoring two channels of audio, selectable in channel pairs using the Control Panel application. Typically used with a pair of headphones.

The Monitor Gain knob on the left adjusts the monitor output level. Pushing in the knob extends it (for adjustment) or recesses it (to prevent accidental changes).

Audio Level Meters

The Audio Level Meters in the center of the front panel indicate:

- During Capture - The first 8 channels of the audio source selected (SDI, HDMI, Analog).
- During Playback - The sum of whatever sources are being played out via the AJA hardware; i.e. NLE timeline and mix of host system audio output (if applicable).

The meter's LEDs are colored to indicate the amount below 0dBfs when averaged over a one millisecond time interval:

dBfs	LED Color and Location
-2 db	Red LED 1 (top)
-12 db	Yellow LED 2
-20 db	Yellow LED 1
-30 db	Green LED 4
-40 db	Green LED 3
-50 db	Green LED 2
-60 db	Green LED 1 (bottom)

NOTE: These audio level meters are for guidance only. Third party audio metering should be employed when doing critical audio editing and mixing.

Status LED

This LED indicates the current connection status of your Io X3.

- OFF: No power detected
- AMBER SOLID: Power is on but Thunderbolt is not live (e.g. Thunderbolt ports disabled in host, BIOS settings)
- AMBER BLINKING: Thunderbolt is awake but no PCIe connection to host (e.g. device hasn't been whitelisted by the Thunderbolt software running on host)
- GREEN BLINKING: Thunderbolt is awake, PCIe is connected, but device doesn't see the NTV2 Driver (This shows up on Windows where the AJA driver has been restricted from talking to peripherals due to a security setting error, or because the AJA software is not installed on the host)
- GREEN SOLID: Thunderbolt is communicating properly

AJA Control Panel Overview

The AJA Control Panel is a software application that provides a simple visual showing how the Io X3 hardware is currently configured and allows you to make changes. You can change signal input and output parameters and define the video processing that will be performed.

The AJA software installer automatically installs the Control Panel application on your computer. You'll find the AJA Control Panel application in your Applications folder.

AJA Control Panel Operating Modes

AJA Control Panel has two fundamental operating modes:

Playback Mode - Used for playing back video files from the computer, usually with a non-linear editing application (NLE) or AJA Control Room, through the Io X3 to that card's video/audio outputs for viewing and/or external recording.

Capture Mode - Used for capturing video/audio signals that are coming into the Io X3 from an external source to create video files on the computer using AJA Control Room or an NLE, live streaming from a third party application, or just for display on the Io X3 outputs. This mode is also used for stand-alone video display or conversion when Control Panel is being used without an external controlling application.

The current Io X3 operating mode is reported on the Control Panel UI screen, below the block diagram (see [Figure 2 on page 15](#)).

AJA Control Panel User Interface

The AJA Control Panel user interface includes a visual block diagram of the unit's current configuration. The current status, input and output settings, and many other details are depicted in the color-coded block diagram. Below this block diagram are various controls for changing operating parameters, which will vary depending on which function screen has been selected.

NOTE: AJA devices can automatically adjust settings for specific signal inputs, outputs, and processing. This information is reported on the AJA Control Panel's block diagram. One example is if outputting 4K, HFR, YCbCr 4:2:2 10-bit from the framebuffer, if the HDMI transmitter is version 1.4b the video is automatically adjusted to 4:2:0 8-bit (e.g. Io X3 MultiView output).

The left side of the AJA Control Panel provides a navigation list of available function screens. Clicking on a link (or alternatively, a related element in the block diagram) displays a function screen corresponding to that topic.

Figure 2. Io X3 Control Panel User Interface

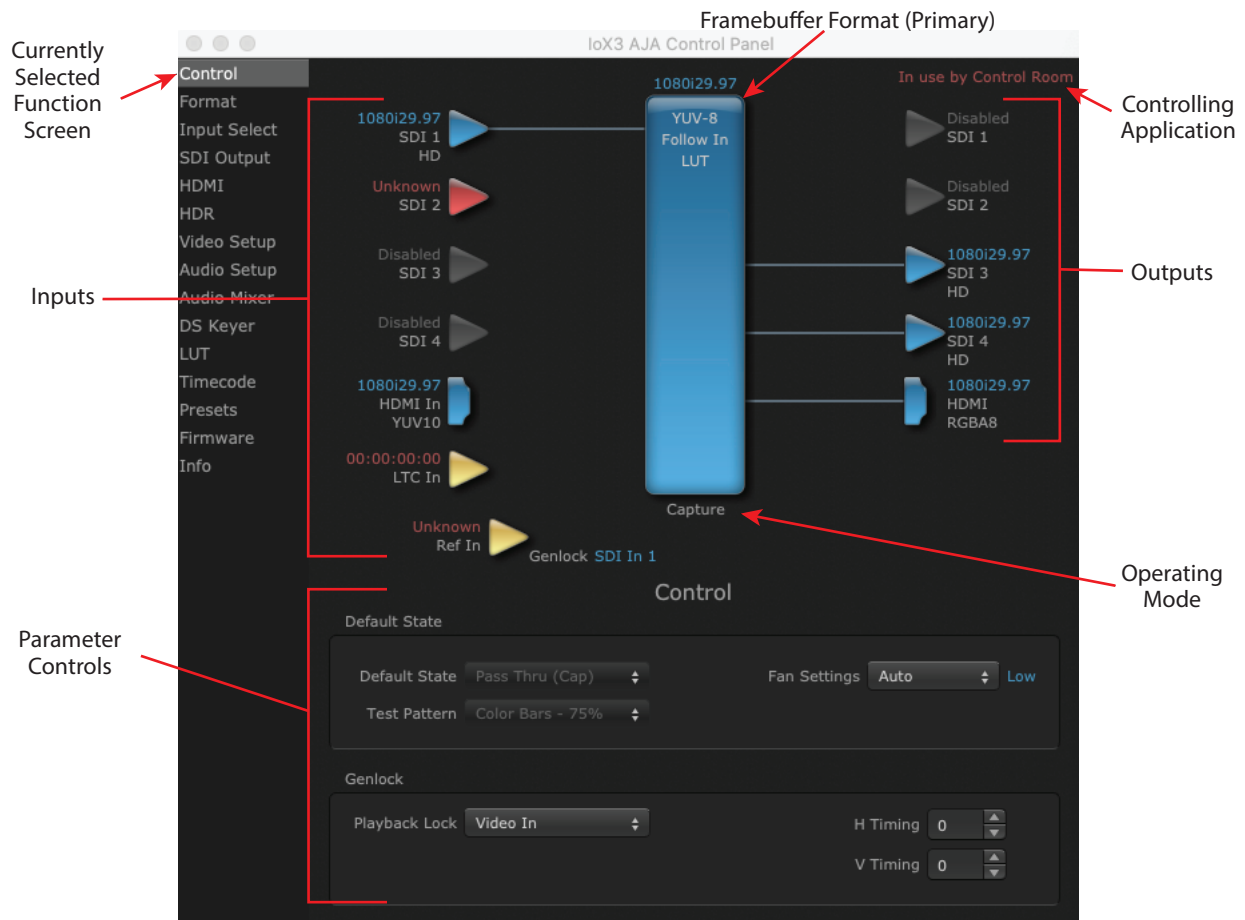

Some controlling applications can switch the card's mode from Playback to Capture, and vice-versa. When Control Panel is not being controlled by an external application, you can change the operating mode in the Control Panel Control Screen using the Default State settings.

- Selecting Passthrough (Cap) sets the card to Capture Mode
- Selecting either Test Pattern (PB) or Hold Last App sets the card to Playback Mode

See "[Default State](#)" on page 22 for more information.

Block Diagram Area

The top block diagram area of the Control Panel screen is a visual representation of the processing, if any, that's currently occurring, including inputs/outputs, reference source, and system status. Lines between inputs, the framebuffer, and outputs, show a video path. Where there are no lines, there is no connection; this can be because an input or output isn't selected in the Input Select menu. The lines will also show whether the outputs are video or video + key.

You can click any of the function screen selection links in the left column to view its current settings or click on an icon to call up its related settings screen. You can also right-click or Control-click to see context-sensitive information and choices ([Figure 3](#)).

Figure 3. Context Sensitive Menu

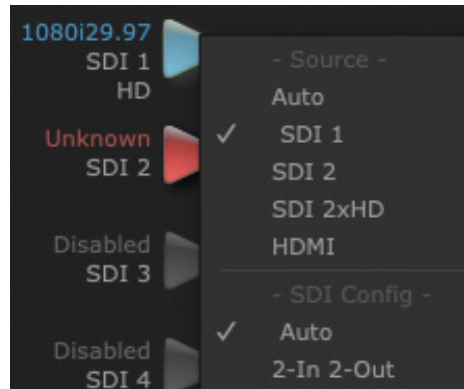

Color Meanings

All items in the AJA Control Panel block diagram are color-coded to show what is happening in real time. This applies to both icons and text. These colors indicate:

Blue - Video is same format as the Device Format (framebuffer)

Yellow - Reference video (black burst or other reference source)

Red - The selected operation cannot be performed

Input/Output Icons

The input and output icons are triangles that together with their color show all the input and outputs and their status (selected, not selected, input present or not, format, etc.). A complete video path is shown when inputs and outputs are connected with lines going to/from the framebuffer.

Figure 4. Input/Output Icons

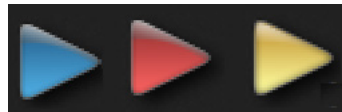

NOTE: Hovering your cursor over an Input or Output icon opens a tooltip that reports that connector's signal status (Input signal detected, Output signal enabled, Input or Output disabled).

Framebuffer

The framebuffer is the "engine" where your third party applications interface with the AJA device. The framebuffer has a format (called the "Device Format") and color space that it follows, as defined in the linked menu screens or via external application software.

Device Format

The Device Format is the media format written to disk and used in your project. This is the format that the framebuffer will use and is shown in the Control Panel using the color blue. It is the format that the third party application software will either receive from the AJA hardware, or is sending to the hardware. All icons in blue are the same as the Device Format used by the framebuffer. Also any text descriptions in the block diagram that appear in blue indicate that something is in the Device Format. For example:

- If the input and output icons are blue, you know that the same format is used throughout the video path. No format conversion is being performed.
- If the input or output icon colors differ (blue input and green output icons for example), you know that a format conversion is being performed.

Controlling Application

It is important to understand that the computer can contain many applications that can use the AJA device (as you switch from window to window) and it may not always be obvious which currently controls it.

Figure 5. Control Panel In Use Message (in red)

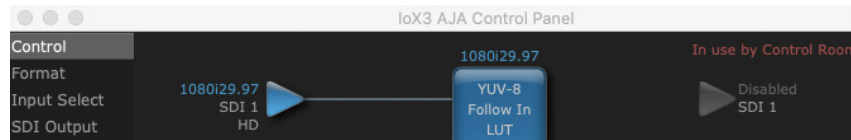

In the top right corner, the Control Panel displays the name of the application controlling the unit. In some cases, applications may not always properly “let go” of the I/O interface as another takes over—you’ll be able to tell by looking at the Control Panel.

Controlling Application Format Selection

If a running controlling application uses io X3 for capture or output, it controls the Device Format via its own menus and settings. For example, when the Third party editing application is active (it’s the front-most application) and has io X3 as its “A/V Device”, the io X3’s Device Format is determined by the application’s “Video Playback” settings. These format selections are reported in the AJA Control Panel block diagram.

Controlling applications can start and stop and change modes—even while they are running. And the behavior of different controlling applications can vary: some applications take control of the interface as soon as they are launched and don’t give it up until they quit, while other applications take control of the interface only when they are the “front-most” running application and then relinquish control when they’re not. Even these controlling applications may not relinquish control until capture or output operations are completed.

AJA Control Panel Restart Services

AJA Control Panel Restart Services allows for restarting the AJA services if necessary. This can help if various applications begin contesting for access to the Video I/O device. In this situation an **AJA Agent is not running** message can appear as the controlling application status. Hovering your cursor over that message displays a **Restart Agent** button, which clicking on will bring Control Panel back to its startup state. Then an application can freshly acquire control of the I/O device.

Figure 6. Restart Services Popup Message

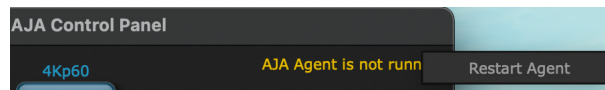

NOTE: On Windows computers you must run Control Panel as Administrator in order to use the restart services feature.

Control Recommendations

We recommend you have the Control Panel running and visible at all times. When the Control Panel is running in the background (not front-most) you can see what the interface is doing and who has control of it.

Presets

Setups can be named and saved as a snapshot (Preset) for recall at any time. You can save various AJA device Control Panel configurations associated with your frequent tasks. You don't have to spend time resetting interface configurations, just load the previously saved Preset for each task. See "[Saving, Loading and Deleting Presets](#)" on page 48 for more information.

If you work on multiple systems and want to carry your saved setups to another location, you can copy your saved Preset files onto movable storage and load them into any computer running the AJA Control Panel application.

macOS Preset Files Storage Location

- From the Finder, hold down the Option key (to display the Library directory) and click on Go/Library/Application Support/AJA/<device name>/Presets/

Windows Preset Files Storage Location

- c:\Users\<username>\AppData\Local\AJA\Control Panel\<device name> Presets\

Default Preferences

When an AJA device starts up, a preference can determine what settings it will have it when it begins to operate. The AJA Control Panel offers two default preference settings:

- Local Preference - A preference stored from the last AJA device's Control Panel settings to be used on next startup of AJA Control Panel. This occurs on next restoration of the default state (triggered by start up of host CPU, startup of the AJA device, or when a third party application releases the AJA device).
- Global Preference - A preference saved for use as a global default start state for an AJA device that can be shared by multiple users, applied on first startup, or by pressing the Control Panel **Reset Device...** button.

Local Preference

The Local Preference file (com.aja.devicesettings) exists to immediately and automatically store all parameter changes made by a user on a particular AJA device. When any control is changed in the Control Panel, that change is recorded in the Local Preference file stored in a unique location on that computer that is dedicated to that particular device, serial number, and logged-in user. Then, when AJA Control Panel is restarted for any reason, the AJA device being controlled restores the settings being used when Control Panel was last closed.

The Local Preference file can be accessed at the following locations.

On Mac:

- From the Finder, hold down the Option key (to display the Library directory) and click on Go/Library/Preferences/com.aja.devicesettings.

On Windows:

- C:\Users\<USER_NAME>\AppData\Local\aja\com.aja.devicesettings

NOTE: Clicking on the AJA Control Panel "Erase All Prefs" button deletes the existing Local Preference file from this location. This file will be recreated as soon as any Control Panel setting is changed.

NOTE: Clicking on the AJA Control Panel "Reset Device..." button will delete the existing Local Preference file. If a Global Preference file is found, these settings are reloaded. If a Global Preference file is not found, "factory defaults" are loaded and the device is set to that state

Global Preference

An administrator can establish a house standard for an AJA device by copying a preference file to a shared computer location. Once placed at that location, it becomes a Global Preference file where it will establish a standard default startup state for all users of that AJA device using that computer system. These settings preempt the initial AJA factory default settings, and are applied when an AJA device is first powered up, or when the Control Panel **Reset Device** button is pressed.

To establish a Global Preference, the administrator first configures the AJA device (which automatically creates a "com.aja.devicesettings" Local Preference file in the location identified above) and then copy or move that file to the correct computer locations (manually or by pushing it out across the network) on all the computers that use the AJA device.

NOTE: If the user makes changes to an AJA Device's Control Panel settings, those changes are saved to the Local Preference file, which will take priority over the Global Preference file.

The shared computer locations for a Global Preference file are:

On Mac:

- From the Finder, click on Go/Computer/<System HD>/Users/Shared/AJA/ and copy or move the "com.aja.devicesettings file" described above to this location.

NOTE: The "AJA" folder needs to be created manually at this location before moving the preference file into it.

On Windows there are three possible shared locations depending on your system:

- C:\Users\Public\Aja\
- C:\Users\All Users\Aja\
- C:\ProgramData\Aja

Copy or move the "com.aja.devicesettings file" described above to one of these locations.

NOTE: The AJA Control Panel Info screen displays the path to the Global Preference file on that computer.

NOTE: Clicking on the AJA Control Panel Erase All Prefs button does NOT delete an existing Global Preference file from this location.

Function Screens

Listed below are the function screens for Io X3 and what they are used for.

Table 1. Io X3 Function Screens

Screen	Functions
Control	Configure basic Io X3 operation options and output timing.
Format	Select the framebuffer primary video format settings.

Screen	Functions
Input Select	View and edit input selections and audio mapping.
SDI Output	Select output format.
HDMI	Configure the HDMI I/O, including MultiView
HDR	Configure High Dynamic Range settings
Video Setup	Configure Video such as progressive format and color space.
Audio Setup	Configures Audio options such as analog audio input and output channels, audio monitor level, and audio delay.
Audio Mixer	Select and mix audio sources for monitoring.
DS Keyer	Setup and control the insertion of keyed video from the frame buffer or graphics files with alpha channel.
LUT	Load a lookup table (LUT) file to adjust the calibration of color for any source.
Timecode	Monitors SMPTE 12M-2 timecode and configure timecode window burn output.
Presets	Add or delete saved preset configurations (handy for quick and easy recall of different lo X3 settings for varied workflows).
Firmware	Install firmware from your currently installed AJA software package.
Info	Display status information and the firmware version number. This information is generally intended for troubleshooting/support.

lo X3 Audio Monitoring

lo X3 hardware can be used as your single audio monitoring solution whether you are auditioning music in a web browser, playing a movie file on the desktop, creating music, or playing a YouTube clip. As long as the output of your work or application is normally output via the host system audio, your AJA hardware can route this audio for monitoring. This cuts down on unnecessary cabling, and means you can take advantage of a consistent audio monitoring environment whatever you are currently doing with your host system.

NOTE: *On first use, you will need to tell your operating system to use AJA hardware as the default Input and Output hardware.*

lo X3 lets you listen to Host System audio concurrently with your NLE audio. This is useful if you need to audition music tracks against playback of your NLE timeline, or if you need to Zoom with a remote producer during an edit session, or for a myriad of other reasons.

You can also listen to lo X3 Input concurrently with your NLE. This is useful if you need to listen out for the readiness of talent, or the presence of some other feed, whilst you continue to work.

lo X3 audio monitoring is routed and mixed using the Control Panel application's Audio Mixer screen. You can select sources to be monitored, and can adjust their levels. If you are using the 1/4 inch monitor output connector, an additional overall mix gain control is conveniently available on the lo X3's front panel.

The mixed audio monitor signal is also routed to:

- SDI Audio out
- HDMI Audio Out
- Analog Audio Out (via DB25 cable)

IMPORTANT: Even though you can hear changes in the signals and levels adjusted with the Audio Mixer screen, these changes are NOT recorded to disk during NLE Capture or Audio Punch In / Voice Over to Timeline. The Audio Mixer screen is dedicated for monitoring only, not program mixing.

Figure 7. Io X3 Audio Monitoring Routing Diagram

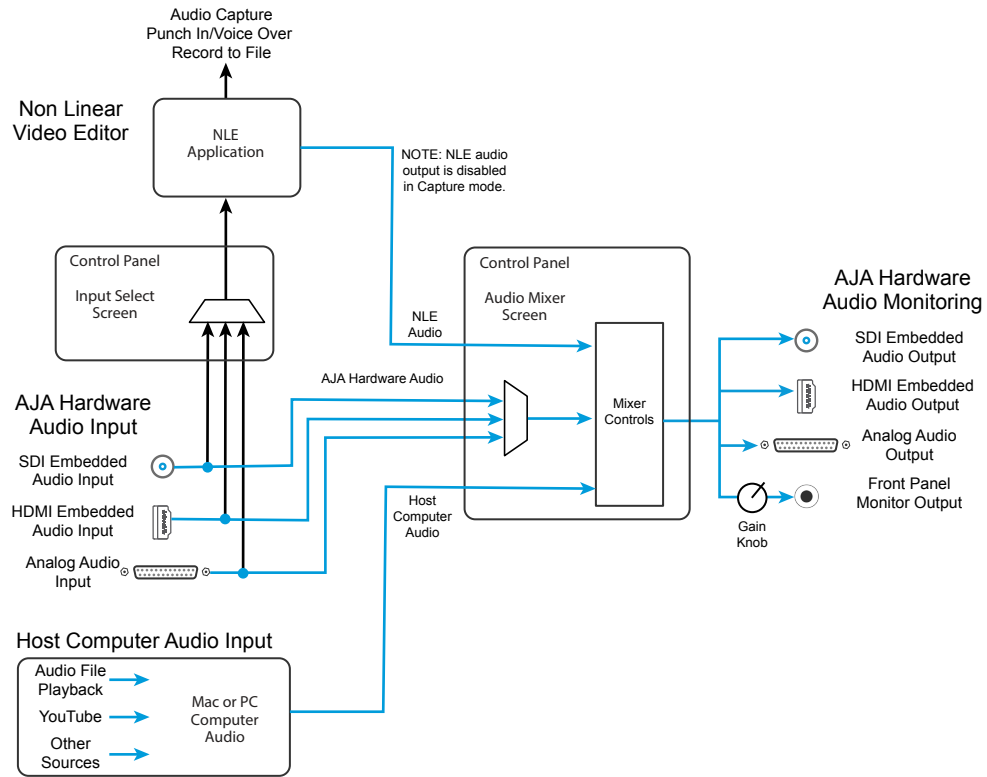

To control which AJA hardware audio is used during recording, you use the Control Panel application's Input Select Screen, Audio Input Select drop-down to select from

- SDI embedded
- HDMI embedded
- Analog (via DB25 cable)

Any level adjustments to Capture or Audio Punch In / Voice Over to Timeline recording operations will either need to be made upstream of the AJA input, or else via adjustments within the main NLE application (e.g. via a pass through mix tool).

AJA Control Panel Function Screens

Control Screen

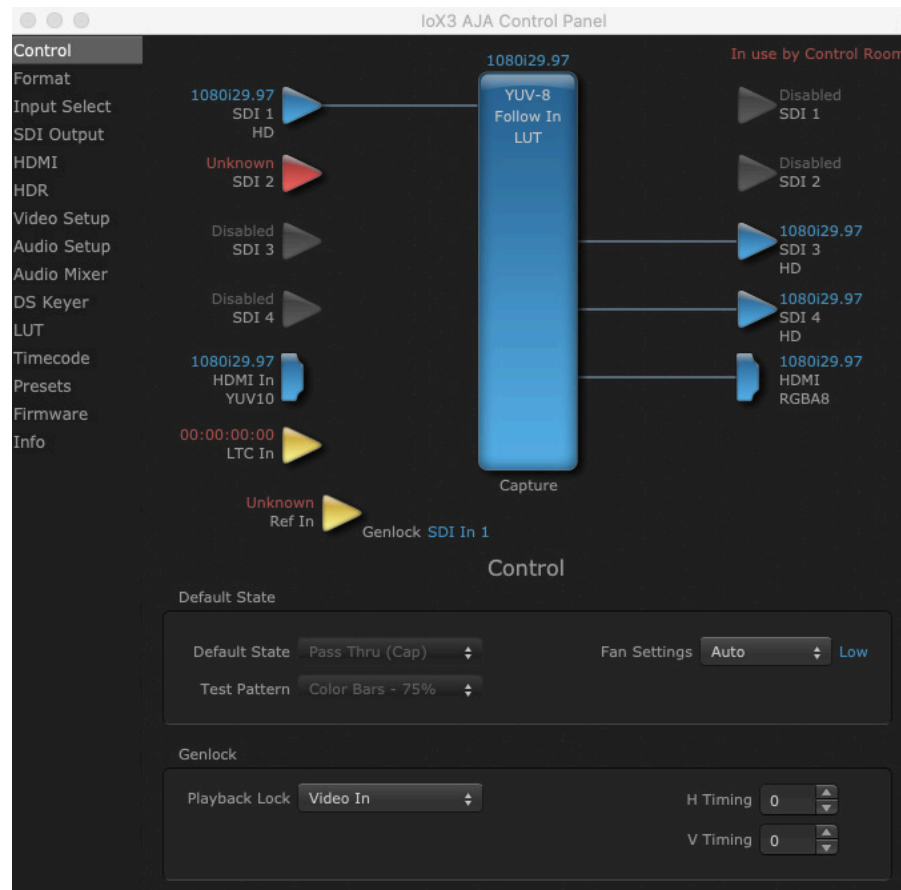

The Control Screen is where you set the Default State, which is what the device outputs when no application has control of the board. This screen also has controls for setting the genlock source, and for setting the Horiz and Vert timing offsets. The top of the Control Screen shows the current state of the device and also shows the name of the Application which has control of the board, if there is one.

Default State

Many video applications can grab control of the io X3, so its outputs can change dynamically. The Default State settings are used to select what state the io X3 will have when no third party video application is controlling it.

Default State

- Pass Through (Cap) - This selection directs io X3 to route video from its selected input through the card for processing and output.
- Test Pattern (PB) - This selection directs io X3 to output a preset pattern when no other application is in control. The pattern is selected from the Test Pattern dropdown list below, or a graphic file can be chosen.
- Hold Last App - This selection directs io X3 to hold and output the last frame of video from the last application to control io X3. This can be helpful when operating in an environment where you're switching back and forth between multiple application windows.

Test Pattern

With Test Pattern selected above, you can choose the pattern type. Select from:

- Black, Color bars (75% or 100%), Ramp, Multiburst, Line Sweep, Multi Pattern, or Flat Field, Check Field, White, Border, Linear Ramp, Slant Ramp, Zone Plate, Color Quadrant, or Color Quad Border.

For HD with RGB-12 Pixel Formats the following HDR test patterns are available:

- HDR Zone Plate, HDR Linear Ramp, HDR HLG Narrow, HDR PQ Narrow, or HDR PQ Wide.

Graphic File Display

In addition to the test patterns above, a “Load File...” selection at the bottom of the Test Pattern dropdown menu allows you to load a standard RGB/RGBA graphics file (.tif,.psd, etc.) into the frame buffer for display (including alpha channel). Some graphics formats and bit depths may not be supported. Files that have been loaded are listed for quick reuse. Loaded graphic files are retained for redisplay if another test pattern is selected, and even if Io X3 is power cycled.

NOTE: A loaded graphics file will not be scaled to fit. If it's smaller than the current frame buffer format, Io X3 will center it in the frame. If larger than the current frame buffer format it will be cropped.

- Clear Files - This selection on the pulldown clears all the Graphic Display files.

Fan Settings

Io X3 offers a fan speed control. The High setting forces maximum fan cooling, with some increased noise, but this setting could be appropriate if the unit is located in, for example, a machine room rather than an editing suite.

- Auto - Fan speed controlled by temperature, increasing or decreasing automatically.
- High - Fan always operates at its highest speed.

Genlock

Use these controls to select Io X3 Genlock settings and adjust Timing.

Playback Mode has three Playback Lock settings:

- Auto: Automatically sets the recommended default settings of Free Run for Playback mode and Video In for Capture mode
- Free Run: Generates sync without an external reference source
- Reference In: Uses the Ref Video source for sync (usually an analog black burst video signal)
- Video In: Uses whichever video input source has been selected in the Inputs screen for sync

Alternative Genlock settings will not cause capture or playback errors, but will make the NLE system take a bit longer shut down in one mode and then lock back up in the other mode, during which time some flashing may appear on the monitor.

Timing (Horiz and Vert)

These two drop-downs allow output timing adjustment with reference to the Ref Video source selected.

- Horizontal: The Horizontal reference can be adjusted by selecting a number of pixels (clocks) to offset
- Vertical: The vertical reference can be adjusted by specifying a number of lines to offset.

Format Screen



The Format Screen shows the video format currently in use by the lo X3 framebuffer (called the Device Format) and allows you to change it. All throughout the Control Panel, choices are always presented based on what lo X3 can do with the signals available and the inputs/outputs selected.

AJA Device Format

Video Format

This drop-down menu shows the currently selected Device format. If you select an alternate value using the drop-down, it will change the format used by lo X3's framebuffer.

When a change is made via the Video Format drop-down or by clicking an icon and selecting a new format via a contextual menu, the block diagram will change to reflect the new format.

Pixel Format

Use this pulldown menu to choose: YUV-8, YUV-10, ARGB-8, RGB-10, or RGB-12.

RGB Range

The RGB Range pulldown menu allows you to select either Auto, Full-range (0-1023) or SMPTE range (typically 64-940) for RGB color output.

NOTE: The AJA Control Panel software uses the abbreviation “sf” instead of “PsF” when referring to “progressive segmented frame” formats. In the manual and in other literature you may see either of these acronyms used interchangeably. Visually, it is easier to recognize:

- “sf” for progressively segmented frame formats
- “p” for progressive frame formats

Follow Input

Enabling the Follow Input checkbox allows the Control Panel Frame Buffer to auto-switch to the detected input format. This feature works only if the controlling application supports input-based capture—AJA Control Room for example.

NOTE: RGB Range is only used when the SDI input or output is configured for RGB.

Input Select Screen

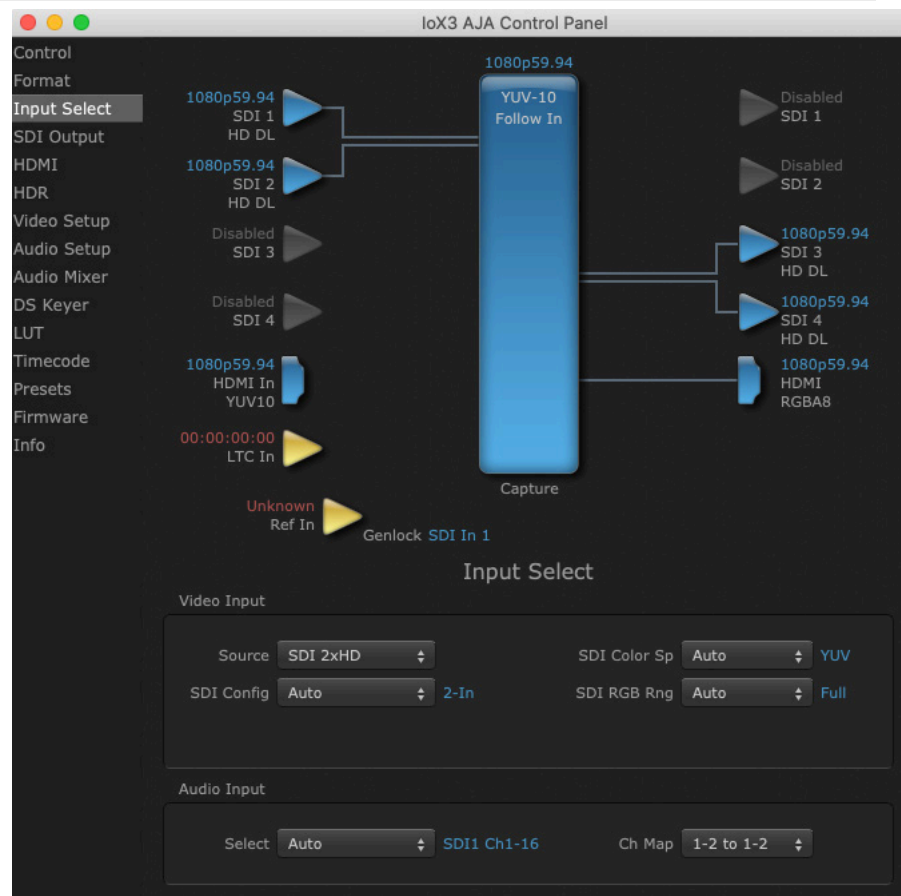

On the Input Select screen you can view or set the currently selected video and audio input sources and map audio sources to the channels supported by your editing application. Two information panes in the screen are provided: Video Input and Audio Input.

Video Input

Source

The pulldown menu allows you to select the currently selected video input source. Select from:

- Auto - Automatically selects the source depending on input format.
- SDI 1, SDI 2, SDI 3, or SDI 4
- SDI 2x HD
- HDMI

SDI Config

- Auto - Automatically selects the source depending on input format.
- 2-In 2-Out - SDI 1 and SDI 2 will be used for individual input sources and SDI 3 and SDI 4 will be used for outputs.
- 4-In - SDI 1 - 4 will all be used for individual input sources, required for MultiView operation.

NOTE: Only HD input sources can be used when "4-In" is selected for SDI Config and "MultiView" is selected for HDMI Output. See "[HDMI Screen](#)" on page 29 for more information.

SDI Color Sp

- Sets the color space. Select from Auto, YUV, or RGB.

SDI RGB Rng

Sets the RGB range. Select from Auto, SMPTE, or Full.

Audio Input

Select

This pulldown menu allows you to pick where the audio comes from. Select from:

- Auto
- Analog
- HDMI
- SDI 1 Ch1-16
- SDI 2 Ch1-16

Ch Map

If only two channels were selected in the third party application you are using, you can select which two channels will be mapped to that application. Different Audio Input selections have different channel mapping capabilities. Select from:

- 1-2 to 1-2
- 3-4 to 1-2
- 5-6 to 1-2
- 7-8 to 1-2
- 9-10 to 1-2
- 11-12 to 1-2
- 13-14 to 1-2
- 15-16 to 1-2

NOTE: This setting does not affect the embedded audio being sent to the Io X3's BNC or HDMI output connectors.

SDI Output Screen

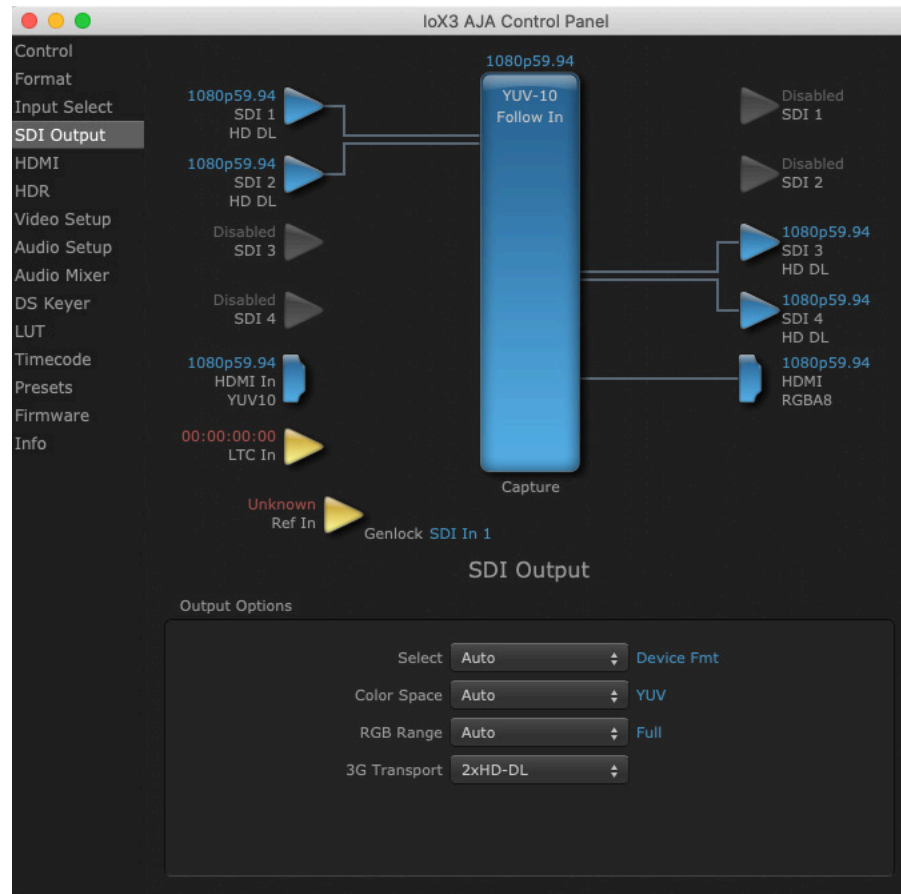

The SDI Output screen shows the current settings for the SDI outputs. The outputs can be configured independently. If an input/output has no video, it will be indicated on the block diagram (“No Video”).

Output Options

Select

- Auto - Automatically selects the output format, based on the input or selected format.
- Device Format - Selects the framebuffer format for output.
- Video+Key - When selected, this indicates that the SDI 3 video is set to the same format as the framebuffer. SDI 4 is set to a video key signal associated with SDI 3 (the shape to be cut out from the video, which will appear as a black and white image/matte). Using the second io X3 output as an Alpha Channel key, with the video output, may be useful for feeding production switchers, DVEs or other professional video equipment.

Color Space

The Color Space pulldown allows you to choose between two “Auto” modes, or to explicitly force the output to a desired color space regardless of the attached device’s EDID or user application needs.

- Auto Detect - (most reliable) AJA device attempt to reconfigure the HDMI output to match the current color space setting of the output monitor EDID. This option will be the most reliable in creating an output image. However, the

output may result in an inferior image due to color space conversion and loss of bit depth.

- Auto - The AJA device will attempt to automatically set the output monitor into the best color space and bit depth regardless of EDID of the output monitor. This may result in loss of image if the output monitor does not support a specific color space.
- RGB - Forces the use of RGB (required for LUT operations).
- YUV - Forces the use of YUV.

RGB Range

Sets the RGB range. Select from Auto, SMPTE, or Full.

3G Transport

Sets the output transport. Select from:

- Auto - Auto selection based on input or selected format.
- 2xHD-DL: Dual link HD output using two BNCs. The Level B-DL format is the mapping of dual-link HD-SDI/SMPTE 372M (i.e.: 1080p up to 60 fps) in a single serial digital interface at the nominal 3 Gbit/s.
- 3Gb - Single link HD output using one BNC. The Level B-DS format is the dual-stream carriage of two independent HD-SDI/SMPTE 292M signals (720p up to 60 fps or 1080i/1080p up to 30 fps) in a single serial digital interface at the nominal 3 Gbit/s.
- 3Ga - Single link HD output using one BNC. The Level A format is the direct mapping of uncompressed 1080p (up to 60 fps) video into a serial digital interface at the nominal 3 Gbit/s.

HDMI Screen

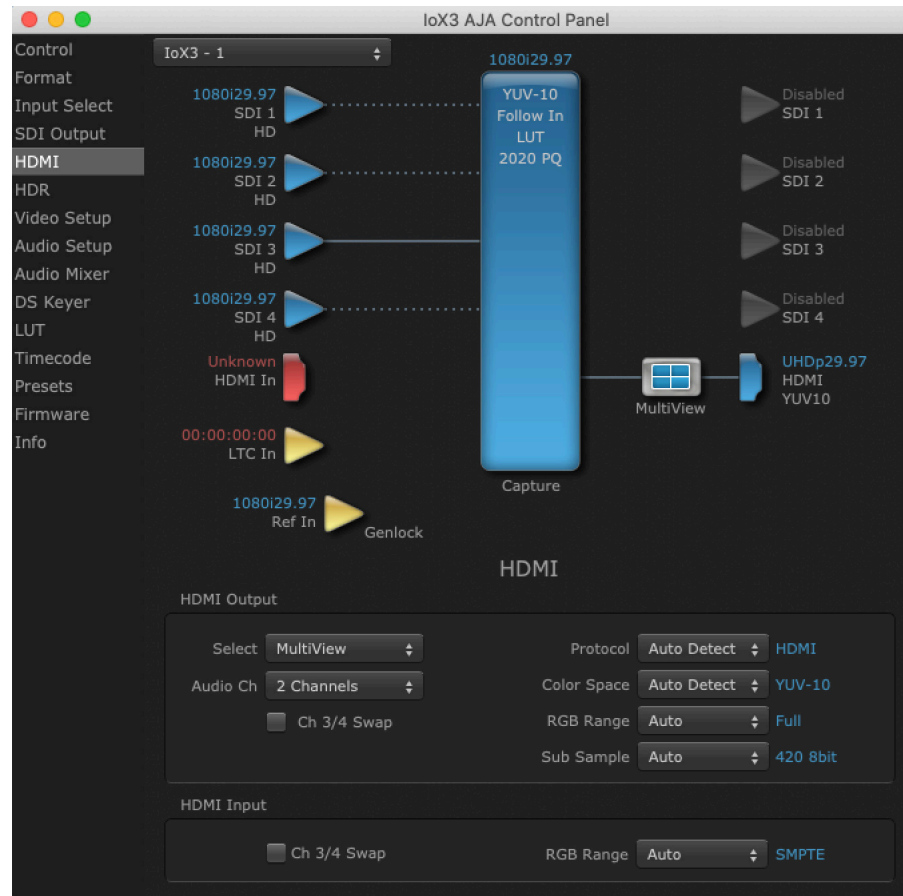

The HDMI input and output are configured with this screen.

HDMI Output

Select

This pulldown lets you select the type of HDMI output.

- Auto - Automatically sets the HDMI output format, based on the input or selected format.
- Device Format - Outputs the selected SD/HD input to the HDMI's output.
- MultiView - Used to create a multi-viewer confidence display of up to four independent HD input signals on the Io X3's HDMI output. The HDMI monitor must be capable of UltraHD. Dotted input lines on the screen indicate MultiView mode is active. The single solid line identifies which input audio will be routed to the HDMI MultiView output (default SDI 1), and also which video and audio source will be used by a controlling application capable of single source capture.

NOTE: Only HD input sources can be used when "4-In" is selected for SDI Config and "MultiView" is selected for HDMI Output. See ["Input Select Screen" on page 25](#) for more information.

Audio Ch

This pulldown allows you to select the number of embedded audio channels for the HDMI output. Select from:

- 2 Channels

- 8 Channels

Ch 3/4 Swap

This checkbox controls HDMI input audio channel placement. Some multi-channel audio decoder systems route the low frequency effects audio to channel 4, and some to channel 3. If you want to monitor or pass audio though to another device, this control can be used to align these two channels correctly.

- Checked - (default) HDMI audio channel 3 is moved to channel 4's location, and input channel 4 is moved to channel 3's location.
- Unchecked - HDMI audio retains the original 3 and 4 channel locations.

Protocol

This pulldown allows you to choose:

- Auto Detect – (most reliable) AJA device attempts to reconfigure the HDMI output to match the current protocol setting of the output monitor. This option will be the most reliable in creating an output image. However, the output may result in loss of audio.
- Auto Set – (best quality) The AJA device HDMI out will attempt to automatically set the output monitor into the best protocol, usually HDMI.
- HDMI – Forces the use of the HDMI protocol regardless of the attached device's EDID. Connection may fail if output monitor does not support the HDMI protocol.
- DVI – Forces the use of the DVI protocol regardless of the attached device's EDID.

Color Space

Sets the color space bit depth. Select from:

- Auto Detect - Selects the appropriate color space depending on signal.
- Auto Set - (best quality) The AJA device will attempt to automatically set the output monitor into the best color space and bit depth that matches the user's application needs regardless of EDID of the output monitor. This may result in loss of image if the output monitor does not support a specific color space mode.
- RGBA-8 - Selects RGBA 8 bit.
- RGB-10 - Selects RGB 10 bit.
- RGB-12 - Selects RGB 12 bit.
- YUV-10 - Selects YUB 10 bit.

RGB Range

This pulldown lets you configure video output range. Choose from:

- SMPTE
- Full

Sub Sample

Determines the output of the quad display when MultiView has been selected.

- Auto – (best quality) The AJA device will attempt to automatically set the output monitor into the best color space and bit depth that matches the user's application needs regardless of EDID of the output monitor. This may result in loss of image if the output monitor does not support a specific color space mode.
- 420 8-bit - Displays each quadrant of the MultiView display as 420 8-bit.
- Half Rate - Changes a MultiView display High Frame Rate output to a Low Frame Rate output.

HDMI Input

The detected HDMI input video format is displayed and you're given a chance to configure the RGB range of the HDMI input.

Audio Ch 3/4 Swap

This checkbox controls HDMI output audio channel placement. Some multi-channel audio decoder systems route the low frequency effects audio to channel 4, and some to channel 3. If you want to monitor multi-channel audio directly or pass audio though to another device, this control can be used to place these two channels correctly.

- Checked - (default) HDMI audio channel 3 is moved to channel 4's location, and input channel 4 is moved to channel 3's location.
- Unchecked - HDMI audio retains the original 3 and 4 channel locations.

RGB Range

Choose from:

- SMPTE
- Full

HDR Screens

Figure 8. HDR Capture Screen Tab

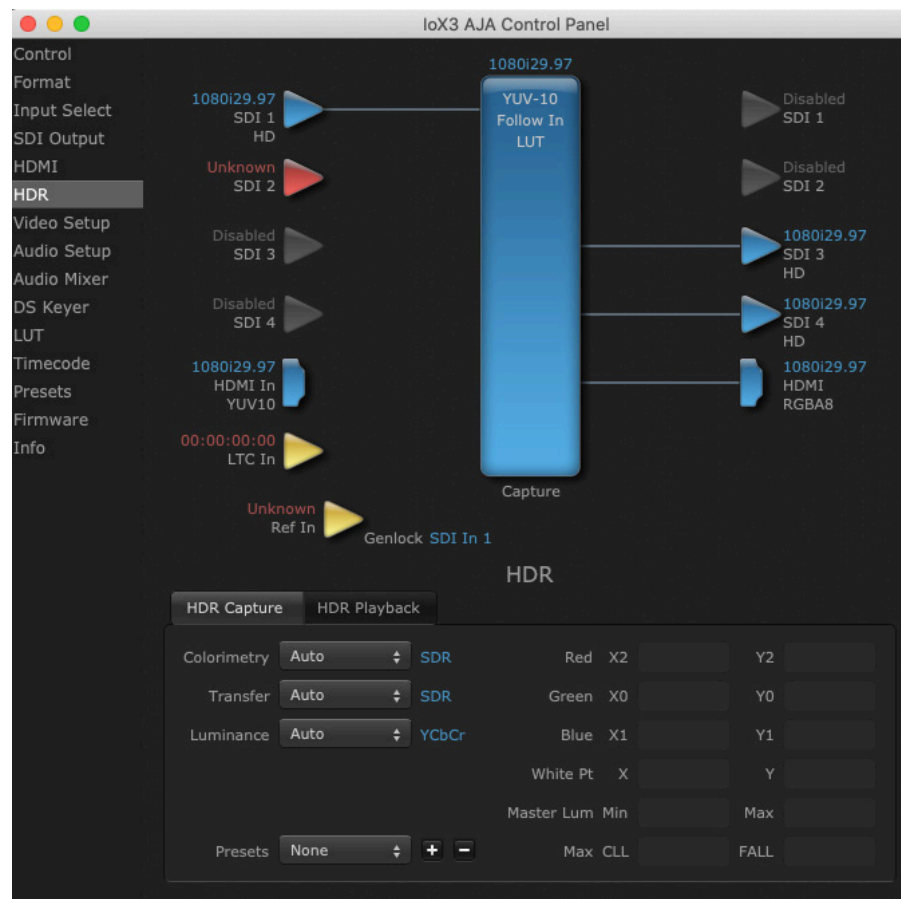

Figure 9. HDR Playback Screen Tab



The HDR screen provides a sub tab setup for HDR playback simultaneously via both SDI and HDMI.

For SDI destinations, the HDR data is delivered in-band using VPID signaling for SDR/HDR Transfer Characteristics, Colorimetry and Luminance.

For HDMI destinations, side-band information is used to inform an HDMI sink device (such as a TV or monitor) that the video content is HDR. This includes generation of the Dynamic Range and Mastering Infoframe and the static metadata descriptors as defined in CTA-861.3 and HDMI v2.0a.

Included are preset primaries values for BT.2020 and DCI P3 color gamuts.

Two tabbed screens are available, for Capture and Playback. The HDR Capture tab settings affect the HDR metadata saved with your captured video, and the io X3's HDMI and SDI outputs while in Capture mode. The HDR Playback tab settings affect what HDR metadata is included on the io X3's HDMI and SDI outputs while in Playback mode.

HDR Capture Settings

Colorimetry

- Auto - (default)
- SDR - Standard Dynamic Range
- P3 - P3 colorspace
- 2020 - BT.2020, typically used with HDR
- Custom - Allows custom values for the Digital Primaries.

Transfer

The Electrical Optical Transfer Function metadata bit tells the HDMI display which EOTF to use.

- Auto - (default)
- SDR - Standard Dynamic Range
- PQ - Perceptual Quantizer
- HLG (Hybrid Log Gamma) - No metadata for Digital Primaries.

Luminance

- Auto - (default)
- YCbCr - YCbCr color space
- ICtCp - IPT color space

Digital Primaries

Selecting Custom HDR Mode allows the editing of digital primaries information that is passed as metadata accompanying the video signal. However, when HLG is selected as the EOTF digital primaries information cannot be edited, because HLG does not use metadata.

Display Mastering Luminance

Represents the minimum and maximum Display Mastering Luminance.

- Minimum: Defines the floor of the SMPTE ST 2086 color volume (in the case of HDR) and is determined by the mastering environment.
 - Range: 0.0000 cd/m² to 1.0000 cd/m².
 - Step size: 0.0002 cd/m².
- Maximum: Defines the ceiling of the SMPTE ST 2086 color volume (in the case of HDR) and is determined by the mastering environment.
 - Range: 1 cd/m² to 65535 cd/m².
 - Step size: 1 cd/m².

Maximum Content Light Level (CLL)

Represents the highest-value pixel component in an entire scene. It is determined by analyzing each frame of video, and can be determined in the post environment.

- Range: 1 cd/m² to 65535 cd/m².
- Step size: 1 cd/m².

Maximum Frame Average Light Level (FALL)

Represents the maximum of frame-based average light levels taken over an entire scene, and can be determined in the post environment.

- Range: 1 cd/m² to 65535 cd/m².
- Step size: 1 cd/m².

HDR Playback Settings

The HDR Playback tab settings are identical to the HDR Capture settings, but affect the Io X3's HDMI and SDI outputs.

Video Setup Screen



The Video Setup screen shows various other settings which will affect how video inputs and outputs behave, and how lo X3 interacts with some software applications.

Video Setup

Progressive Pref

This feature is used to default the hardware to use either p or PsF output over SDI when it has not been specified by the application. Choose between:

- Prefer p Format - progressive frames non-interlaced output
- Prefer psf Format - progressive segmented frames

NOTE: *If you change this option while your NLE is open and running, you may need to then make a change in one of your NLE settings in order for this to be reflected dynamically in the project. For example in Media Composer, simply toggling the Video Quality menu in the Timeline should cause a project format refresh to occur, thus recognizing the change you just made in Control Panel.*

Color Space

Sets the video color space. Select from:

- Auto
- Rec 601
- Rec 709

Gamma

Sets the video gamma. Intended for use with legacy Apple displays. Select from:

- Auto
- Gamma 1.8

VANC Checkbox

When checked, the VANC checkbox tells the lo X3 to capture and process any ancillary data in the SDI stream. This can include different types of metadata. Applications such as Premiere Pro and Final Cut Pro will not capture or output this data through the lo X3 if this box is not checked.

NOTE: lo X3 does not require enabling the VANC checkbox for Closed Captioning.

Audio Setup Screen



The Audio Setup screen shows the current settings for the analog audio output, allowing you to re-configure it when desired.

Audio Monitor

This control selects which pair of channels from the NLE will be monitored. For most editing scenarios this should remain as Ch 1-2, since most NLEs default to dual track / stereo monitoring as a sum of the entire timeline.

NOTE: This setting only applies to dual channel monitoring environments (for example, the headphone jack on the front of the lo X3).

Select from:

- Ch 1-2 through Ch 15-16

Analog Audio Monitor Level

This selection determines the analog audio output level (“FSD” is full-scale-deflection reading as measured on a VU meter). In addition to the front panel monitor (headphone) output, this setting also effects the analog output via the DB25 cable. Select from

- +24dBu, +18dBu, +15dBu, or +12dBu

Analog IO Select

This setting configures the analog audio input and output channels on the DB-25 connector. Choose from:

- 8-Out
- 4-In 4-Out (Ch 1-4 in, Ch 5-8 out)
- 4-Out 4-In (Ch 1-4 out, Ch 5-8 in)
- 8-In

Delay In and Out

Here you can set up to 6 frames (in tenths of a frame) of delay for the AJA device’s audio input and output. The AJA Control Panel delays all audio outputs—SDI, HDMI, and Analog. This feature is useful in compensating for the processing delay of a video monitor when audio is being monitored directly from the Io X3 (for example, when an audio mixer is connected to the DB25 analog audio inputs).

IMPORTANT: If you use this Control Panel delay, do not use other delay settings in your applications, as they can conflict with one another.

Audio Mixer Screens

The Audio Mixer screen has two tabs; Capture Monitor and Playback Monitor. These tabs display what sources are available for monitoring / mixing via the AJA hardware when in either of those two modes (if applicable). The controls on this screen are dedicated only to monitoring adjustments, and do not affect the level at which inbound audio signals are captured to storage.

The selection check boxes and screen slider controls affect the following Io X3 outputs:

- SDI Embedded Audio Out
- HDMI Embedded Audio Out
- Analog Audio Out (via DB25 cable)
- Front Panel Monitor Out (headphone jack) - This level can also be adjusted with the front panel gain knob, and is additive to the screen slider controls.

IMPORTANT: Even though you can hear changes in the signals and levels adjusted with the Audio Mixer screen, these changes are NOT recorded to disk during NLE Capture or Audio Punch In / Voice Over to Timeline. In addition, muting or activating sources on this screen will not affect audio signals being recorded. The Audio Mixer screen is dedicated for monitoring only, not program mixing.

The branching arrow on the lower right indicates which sources are being routed for monitoring in that operating mode, and is colored blue when active and red when disabled.

Figure 10. Audio Mixer Screen Example

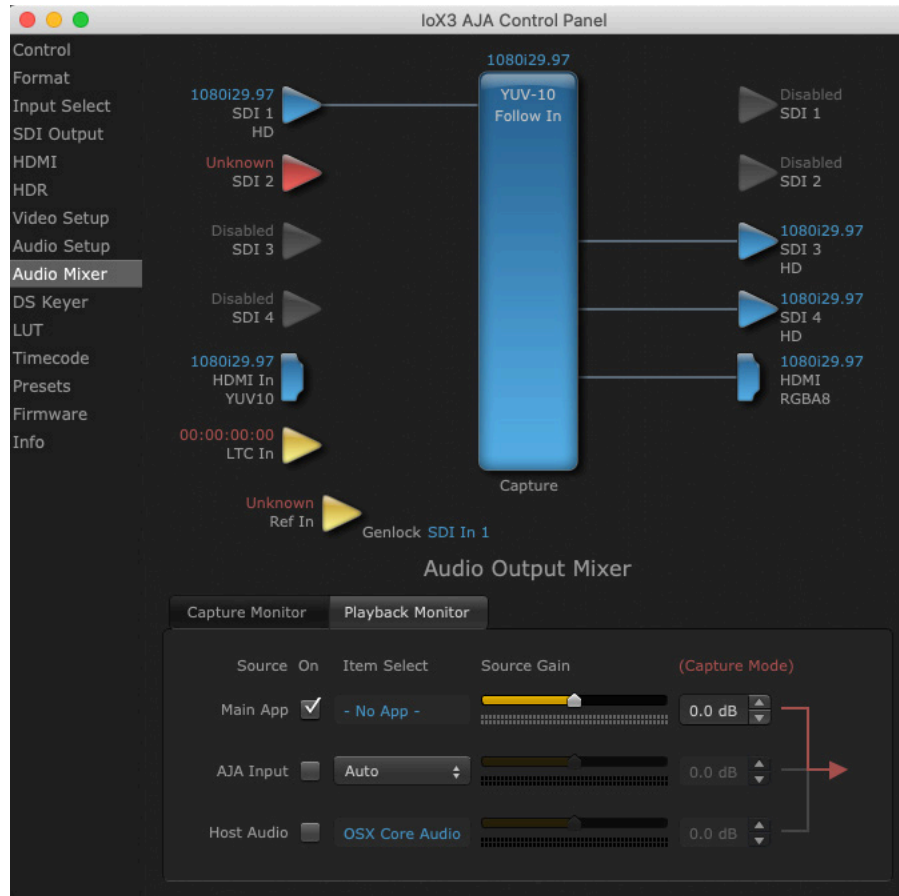

Each source has a confidence meter, which enables you to tell immediately if you have a source arriving correctly at the AJA hardware (without having to launch any other software). The level sliders allow a simple plus or minus adjustment to the Source level being monitored. This is to allow for fine-tuning of your listening environment (on occasions the host system audio can be unexpectedly loud, or an incoming feed may be very loud or very quiet).

Two different Audio Mixer screens are available, selected by clicking on the Playback Monitor or Capture Monitor tabs. During regular editing, the Playback tab is used to control your monitoring experience. During capture operations, the Capture tab is used for your monitoring experience.

Controls in each tab are only in effect when lo X3 is in the correct operating mode, as determined by the controlling application or the Control Panel application's Default State setting. When the mode doesn't match, the mode indicator on the right goes red (see [Figure 10 on page 37](#)). However, settings can be adjusted while in that disabled mode, and will be applied when you return to that operating mode.

Audio Mixer Capture Monitor Mode Screen

Figure 11. Audio Mixer Screen, Capture Monitor Mode

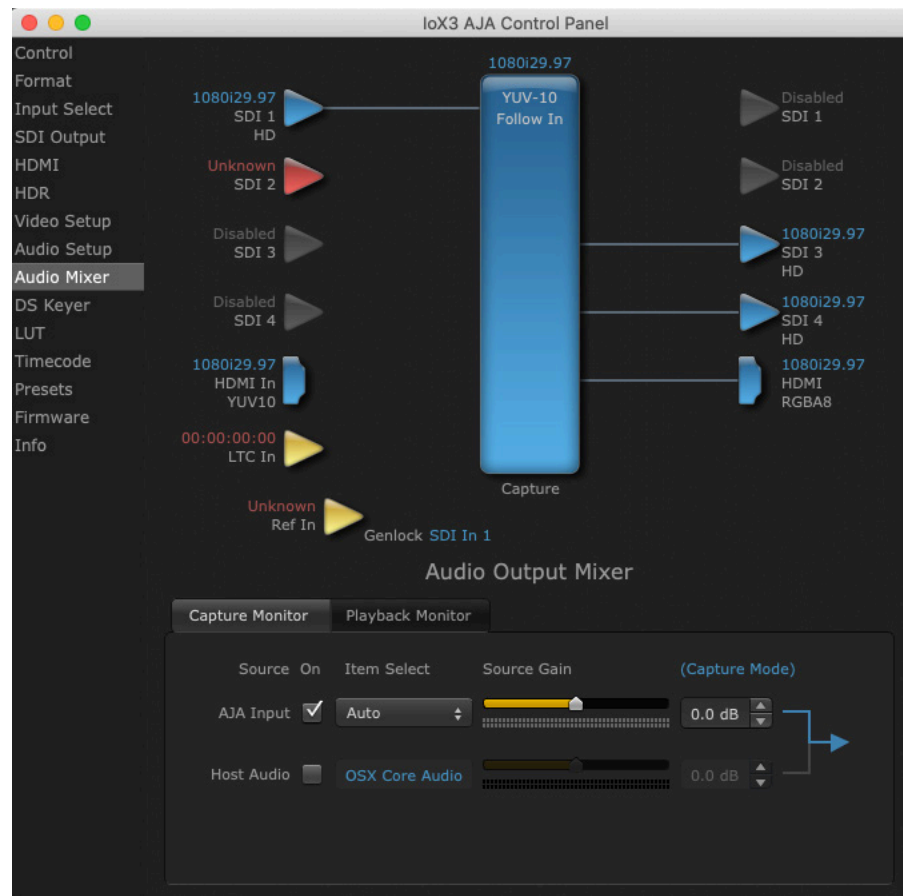

The Capture Monitor Mode screen is used to select and mix audio to be monitored during capture operations.

IMPORTANT: Even though you can hear changes in the signals and levels adjusted with the Audio Mixer screen, these changes are NOT recorded to disk during NLE Capture or Audio Punch In / Voice Over to Timeline. In addition, muting or activating sources on this screen will not affect audio signals being recorded. The Audio Mixer screen is dedicated for monitoring only, not program mixing.

The controls on this screen are similar to those on the Playback Monitor Mode screen, except the Main App is not available for selection (you cannot capture from the application that is capturing). See ["Audio Mixer Playback Monitor Mode Screen" on page 39](#) for more information.

NOTE: If you want different behavior when the Capture tab is triggered; i.e. for host system audio to be muted, then simply check the host system audio in the Capture tab only. This way when you exit NLE Capture and return to regular editing, the Playback tab settings will be applied and your host system audio monitoring will resume.

Audio Mixer Playback Monitor Mode Screen

Figure 12. Audio Mixer Screen, Playback Monitor Mode

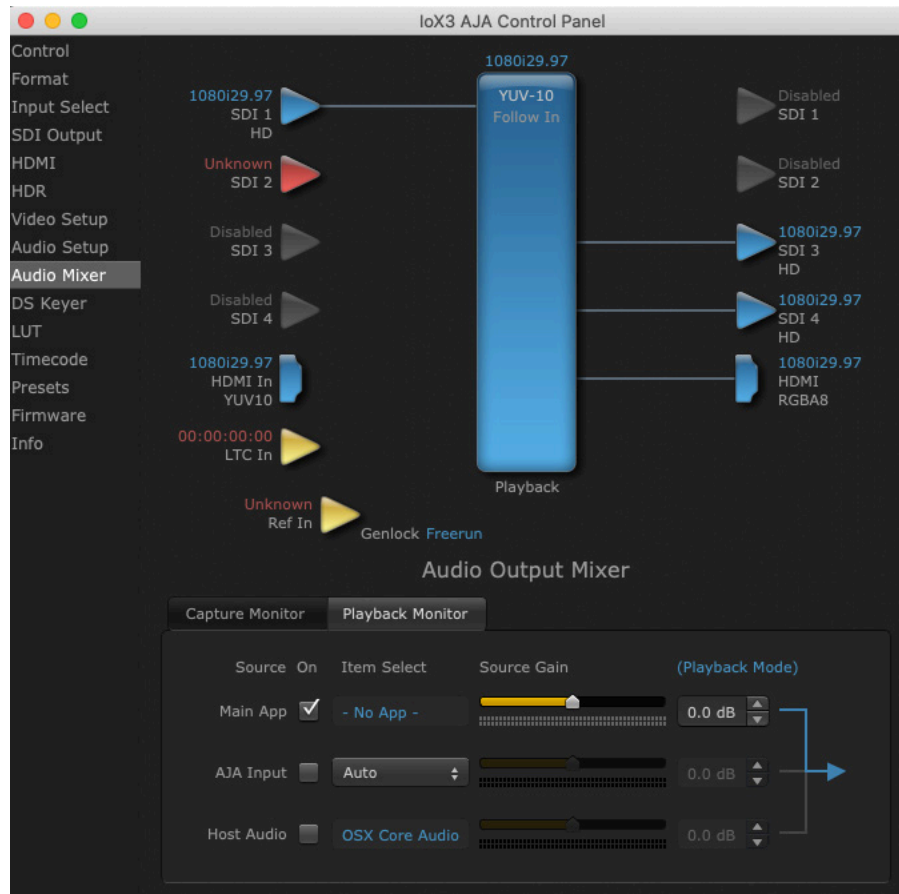

Playback Source Selection

Clicking the **On** checkbox selects the audio for that item for playback to the audio monitor outputs. Multiple sources can be selected simultaneously.

Main App

If an external application is controlling the lo X3, it will be displayed in the **Item Select** column and its audio can be selected for playback with the checkbox.

AJA Input

Selects for monitoring the audio being input to lo X3.

NOTE: The *AJA Input Item Select* dropdown selection is linked to the *Input Select* screen's *Audio Input Select* dropdown. Changing the setting on one screen will also change the setting on the other screen.

In the **Item Select** column, click on the dropdown and choose from:

- Analog - The Analog Audio being received on the lo X3, DB-25 connector.
- HDMI - The embedded audio being received on the lo X3 HDMI In connector.
- SDI Ch 1-16 - The embedded audio being received on the lo X3 SDI In connectors.

Host Audio

Selects the audio from the host computer, thus enabling the AJA hardware to monitor anything that would normally be presented via the host laptop, CPU or computer monitor. For example, an editor could sample music from an online library, while concurrently playing back their NLE timeline. Or, a producer and editor could be communicating live during an editing session, using Zoom or some other video calling tool.

Source Gain

Meters display the input audio levels of the source, colored green when that source is On, and gray when that source is not selected. The levels shown do not change when the gain is adjusted, because the input levels are being monitored, not the output levels.

When activated, the source gain controls can be used to adjust the monitoring output gain of that source, from +6dB to - infinity (mute). Adjustment methods include:

- Sliders - The sliders on the right can be used to change the values for each color.
- Numeric Entry - You also enter a numeric value by clicking on the displayed number, and can increase or decrease the values clicking on the up/down arrow boxes.
- Cut and Paste - Right clicking on a displayed number opens a Cut, Copy, Paste dropdown menu for convenient numeric entry.

As mentioned before, these controls are for monitoring only, and do not change the audio recorded to a NLE file. Any actual recording level adjustments to Capture or Audio Punch In / Voice Over to Timeline operations will either need to be made upstream of the AJA input, or else via adjustments within the main NLE application (e.g. via a pass through mix tool).

DS Keyer Screen



The lo X3 has a hardware-based downstream keyer that is ideal for putting logos, “bugs” or other video material with an alpha channel on top of video being played out or printed to tape.

A typical application would be putting a television station’s call letters or channel over program video content. Keyed video can be from the lo X3 internal Frame Buffer (from storage, video In, etc.) or from a graphics file that has an alpha channel (Photoshop etc.).

Settings in the DS Keyer Screen provide control over how the keyer operates and whether it’s turned on or off.

Mode

Downstream Keyer Off - When this pulldown menu item is selected the downstream keyer will be turned off

- Frame Buffer over Matte - Places the keyed video with alpha channel currently in the Frame Buffer over a fixed color matte determined by the "Matte Color" setting set separately.
- Frame Buffer over Video In - Places the keyed video currently in the Frame Buffer over the video input for playout or print-to-tape.
- Graphic over Matte - Places a graphics file having an alpha channel (chosen in "Graphic File" pulldown) over a fixed color matte determined by the "Matte Color" setting set separately.
- Graphic over Video In - Places a graphics file having an alpha channel (chosen in "Graphic File" pulldown) over the video input for playout or print-to-tape.
- Graphic over Frame Buffer - Places a graphics file having an alpha channel (chosen in "Graphic File" pulldown) over the current contents of the lo X3 Frame Buffer (which might be from storage, Video In, etc.).

Matte Color

Only available when the pulldown "Frame Buffer over Matte" or "Graphic over Matte" are selected, pressing this button brings up a color selection dialog. The dialog provides a variety of ways to select a matte color including a color wheel, color picker (choose from a location anywhere on the computer screen), numeric sliders, swatches, "crayons", and spectrums. The matte chosen will be used as a video background under the keyed video.

Foreground Pre-multiplied

Use to avoid "matte lines" and improve the appearance of the foreground (key) being composited over the background.

Audio Out

- Frame Buffer - Select audio out to be routed from the Frame Buffer.
- Audio In - Select audio out to be routed from the lo X3's selected input(s).

Graphic File

This pulldown allows you to choose from any recently accessed file or select a new file ("Load File..."), which then brings up a file dialogue. You can load any standard RGB graphics file (.tif,.psd, etc.) into the frame buffer for display, but some graphics formats and bit depths may not be supported.

The file raster (pixel x pixel count) should match the Device Format in the frame buffer or the secondary format if up-converting. For example, you wish to key a logo on top of a 1920x1080 footage, the still image with alpha channel that you load should be 1920x1080.

Loaded graphic files are retained for redisplay if another file is chosen, and even if the lo X3 is power cycled.

NOTE: *A loaded graphics file will not be scaled to fit. If it's smaller than the current frame buffer format, lo X3 will center it in the frame. If larger than the current frame buffer format it will be cropped.*

LUT Screen

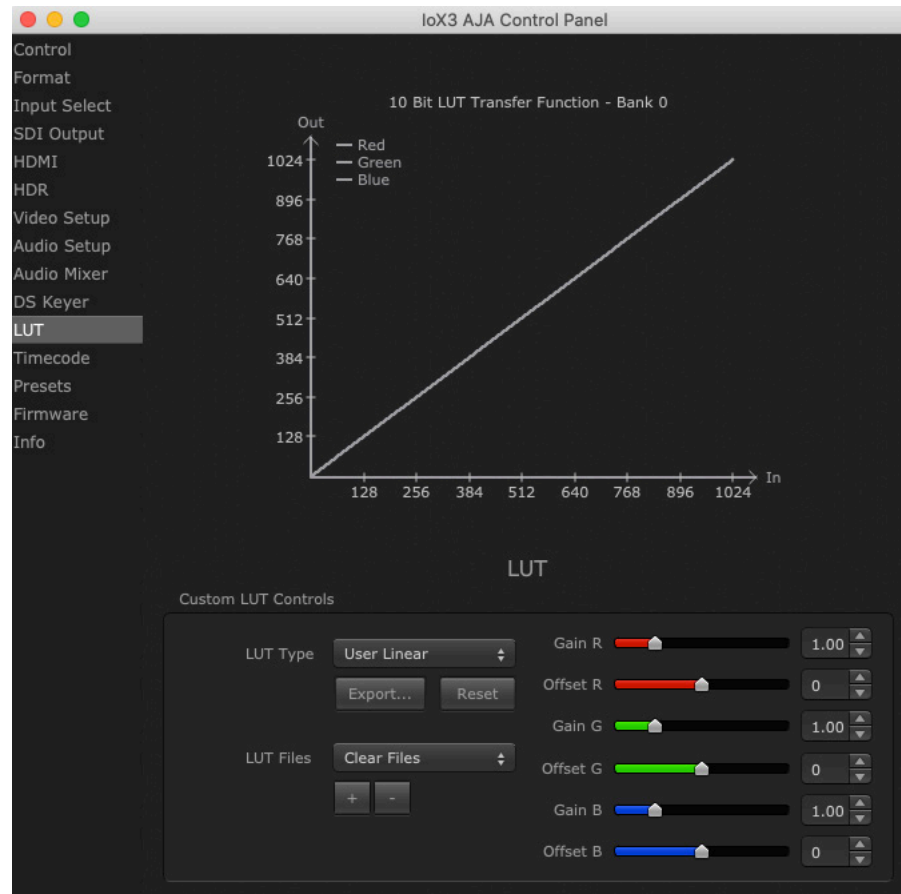

The LUT screen allows you to create a custom 10-bit color look up table (LUT) on the io X3 output, for matching a production "look" on a specific display. These custom LUTs can also be exported as .cube files for use with supported AJA devices and compatible professional applications. Users can also load externally generated LUT files into the io X3 to ensure consistent color among different devices.

NOTE: .cube files are the new standard for importing and exporting LUTs with AJA Control Room as of v16.2. Prior to v16.2, Control Room supported CSV files containing LUT information. While this LUT formatting is still supported for import, it is no longer supported for export.

Custom LUT Controls

The LUT Transfer Function screen displays an approximate representation of the effect of the current LUT settings. When the controls are activated by selecting a User LUT Type, Red, Blue, and Green curves show the transfer functions of each color.

NOTE: The displayed curves are approximate. Curves for some extreme settings may diverge significantly from the actual transfer functions.

LUT Type

Selects the type of LUT. Choose from

- Auto - LUT will be automatically selected. This setting intelligently applies the type of LUT required in the majority of use cases. For example, if the

Frame Buffer is set to SD 608 and the Output set to HD 709, then an industry standard curve for changing 608 to 709 color space is applied.

- Linear - A linear 1:1 LUT is applied, resulting in no color change (every value for source is mapped to the same value for output).
- SMPTE->FullRange - A conversion LUT from SMPTE to Full Range is applied.
- FullRange->SMPTE - A conversion LUT from Full Range to SMPTE is applied.
- User Linear - Activates the Gain and Offset controls, allowing the manual creation of a custom LUT. Initial default setting is linear.

Figure 13. Example LUT Transfer Function Curves

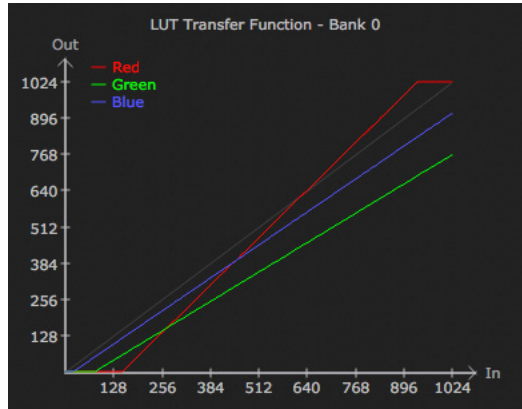

- User Film Stream - Activates the Gain and Offset controls with a default curve matching Grass Valley FilmStream cameras, and also allowing manual creation of a custom LUT.
- User LUT File - See "[LUT Files](#)" below.

Gain and Offset Controls

When activated, the controls on the right allow adjustment of Gain and Offset for Red, Blue and Green.

- Sliders - The sliders on the right can be used to change the values for each color.
- Numeric Entry - You also enter a numeric value by clicking on the displayed number, and can increase or decrease the values clicking on the up/down arrow boxes.
- Cut and Paste - Right clicking on a displayed number opens a Cut, Copy, Paste dropdown menu for convenient numeric entry.

Export

The Export button can be used to save the current LUT values as a .cube file. The LUT file can be named and you can specify the location to save the file. This Export feature lets you take the custom LUT with you and re-import it to another system or location for consistency.

Reset

Clicking on the Reset button resets the currently selected LUT Type to its default values (not active for a User LUT file).

LUT Files

The User LUT File setting above activates the LUT Files dropdown, allowing the selection of a previously saved LUT file. You can create a custom LUT file using most text editors or spread sheets, provided the data is arranged according to the LUT File Format Specification that follows (see "[LUT File Format Specification](#)" on page 45).

Uploading Custom User LUT file

Once the LUT file is created, you can upload it with the following steps:

1. Before loading a LUT, make sure you are using an RGB/RGBA frame buffer format, and that you have a AJA Video Device that supports LUTs.
2. Open AJA Control Panel and select the "LUT" pane.
3. Click the "LUT Type" popup and choose "User LUT File" menu item. Note "LUT Files" options become enabled.
4. Click the "+" button and use the navigation dialog to choose a custom LUT file. The LUT is now loaded.

LUT File Format Specification

LUT files are normal text files that contain 1025 lines (numbered 0 - 1024). Each line contains 3 integer values in the range 0 - 1023, representing 10 bit R, G, B component output values. Component values may be separated by one or more commas, spaces, or tabs. The example below shows LUT File contents for Line 0, Line 1, Line 2, and Line 1024, with several valid ways to separate the numbers in a line, using comma and space, tab, or only space.

- 16, 17, 17
- 17 18 18
- 19 19 21
- 1000, 1022, 1023

In the example above, the first line (Line 0) represents the output values for the case where R=0, G=0, or B=0. In other words, if the R component of a pixel is set to 0, then set R component value to 16. Likewise, if G is set to 0, then set G to 17. The second line (Line 1) does a similar thing for input component values equal to 1.

A simple way to construct a LUT file is to go to user linear in Control Panel and make some modifications, then click export and you will have a .cube file. You can then either import that LUT on a different workstation, or else use a text editor to make manual adjustments if desired.

Timecode Screen

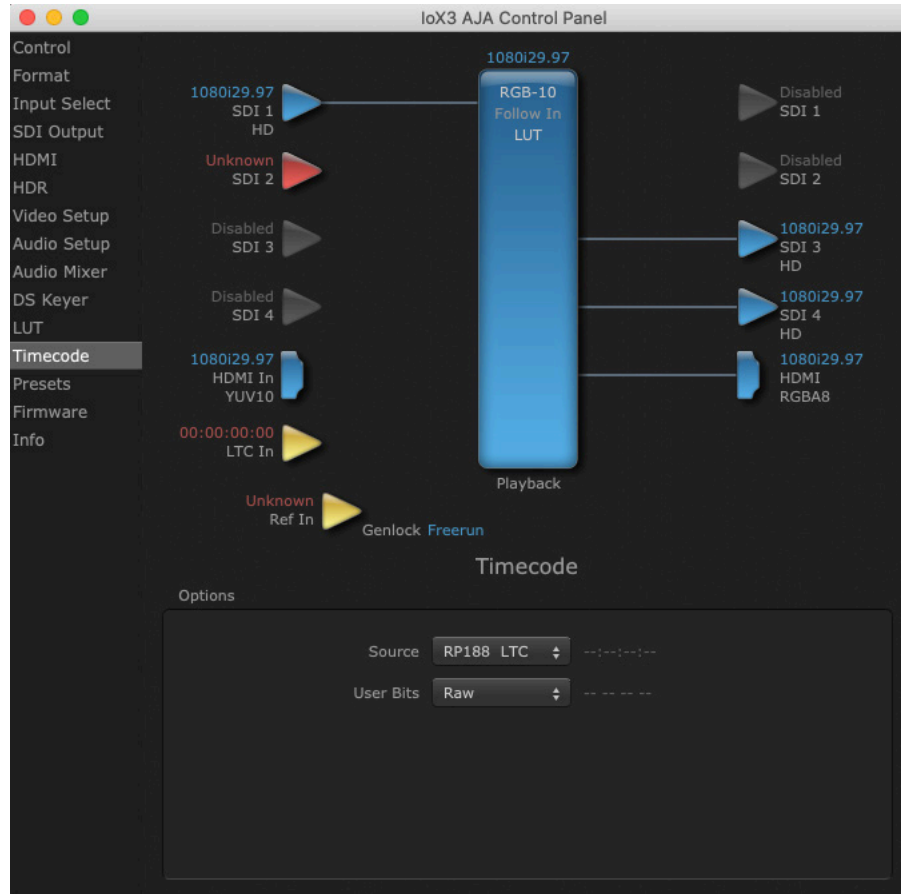

The Timecode screen is used to select the timecode stream read for applications that use it (for example, in AJA Control Room when the Timecode Source preference is set to “Control Panel Setting” that application will read the selected stream). This screen is also used for monitoring the RP-188 timecode embedded in the digital data stream, for selecting a timecode offset (if required), and setting timecode outputs.

Options

Source

In RP-188 timecode (SMPTE 12M-gg2) there can be multiple timecode types in the data stream. Use this drop-down to select the one you wish to monitor:

- RP188 LTC (Linear timecode)
- RP188 VITC (Vertical Interval timecode)
- LTC Port

The selection will be displayed in the timecode value displayed to the right of the drop-down.

NOTE: SMPTE RP 188 defines a standard for the transmission of time code and control code in the ancillary data space of a digital television data stream. Time code information is transmitted in the ancillary data space as defined in ANSI/SMPTE 291M. Multiple codes can be transmitted within a single digital video data stream. Other time information, such as real time clock, DTTR tape timer information, and other user-defined information, may also be carried in the ancillary time code packet instead of time code. The actual information transmitted through the interface is identified by the coding of a distributed binary bit. Equipment manufacturers can use the metadata for different purposes.

User Bits

For monitoring a variable framerate (VFR) timecode (such as Varicam), you may wish to check the User-bits box. If you set this checkbox, lo X3 will detect and interpret the user-bits and display them next to the checkbox. You will see the original framerate (30 fps in the figure below) followed by the adjusted frame padding (two digits reporting discarded and retained frame padding).

NOTE: SMPTE 12M-2 is the updated name and specification for what was RP-188.

Presets Screen

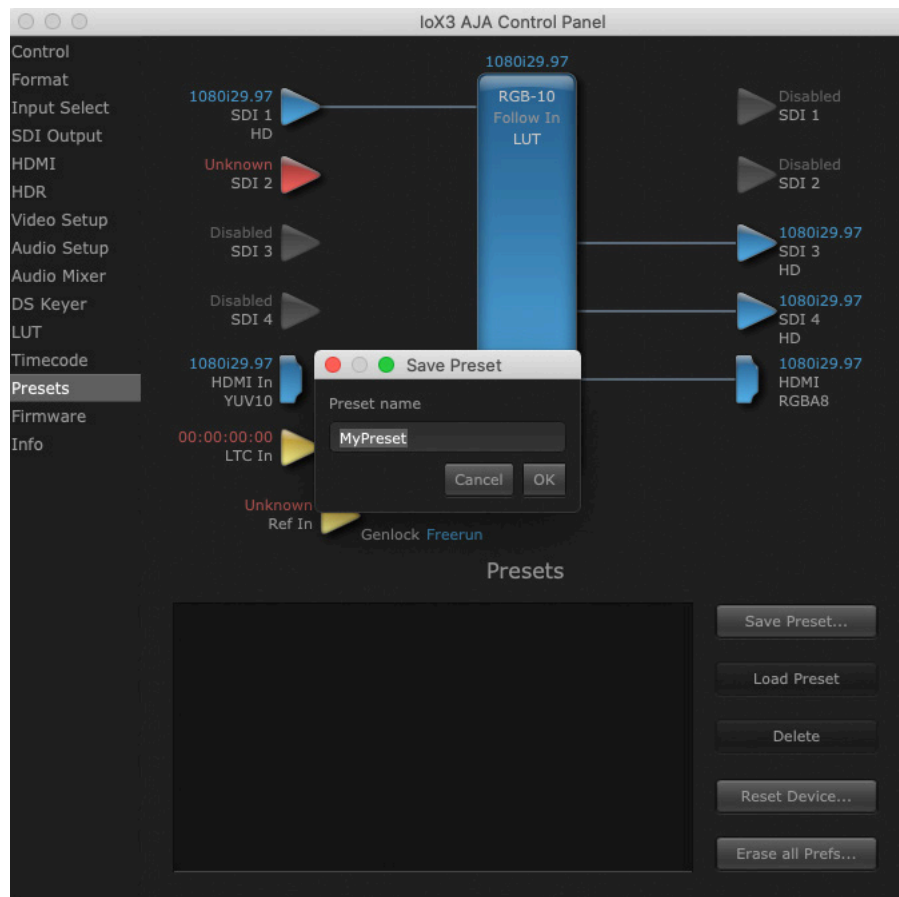

After configuring the AJA Control Panel screens, you can then save all your settings as a snapshot for later recall, called a preset. In this way, you can organize presets for all your typical tasks, eliminating manual reconfiguration.

Saving, Loading and Deleting Presets

To save a preset, simply go to the Presets screen and click "Save Preset". A dialog will be presented asking you for a file name. Enter a meaningful name and click "OK". Thereafter the preset will be available under the Control Panel "Presets" list.

From the Presets screen you can manage your collection of presets easily. To Load or Delete a stored preset, just select it with your mouse and then click the "Load Preset" or "Delete" button respectively .

Transferring Saved Presets

If you want to use a saved Preset on another workstation, you can simply copy the file on removable storage and install it at the new location. The Preset files are stored at:

macOS Preset Files Storage Location

- From the Finder, hold down the Option key (to display the Library directory) and click on Go/Library/Application Support/AJA/<device name>/Presets/

Windows Preset Files Storage Location

- c:\Users\<username>\AppData\Local\AJA\Control Panel\<device name> Presets\

Reset to Default

When you click the "Reset Device" button the Default User Preference file will be deleted and AJA Control Panel will do one of the following:

- If a Default Global Preference is found, it is loaded and the device is set to this state.
- If a Default Global Preference file is not found, "factory defaults" are loaded and the device is set to this state.

NOTE: See "Default Preferences" on page 18 for more information.

Erase all Prefs

For technical support purposes you may be required to remove the current Preference settings. Clicking on the "Erase all Prefs" button deletes the current Default User Preference file without accessing a Default Global Preference file, if one exists. Current AJA device settings are not altered, but changing any setting will immediately regenerate a Default Use Preference file with the changed settings.

NOTE: Clicking on the AJA Control Panel Erase All Prefs button does NOT delete an existing Global Preference file from that shared location.

Firmware Screen

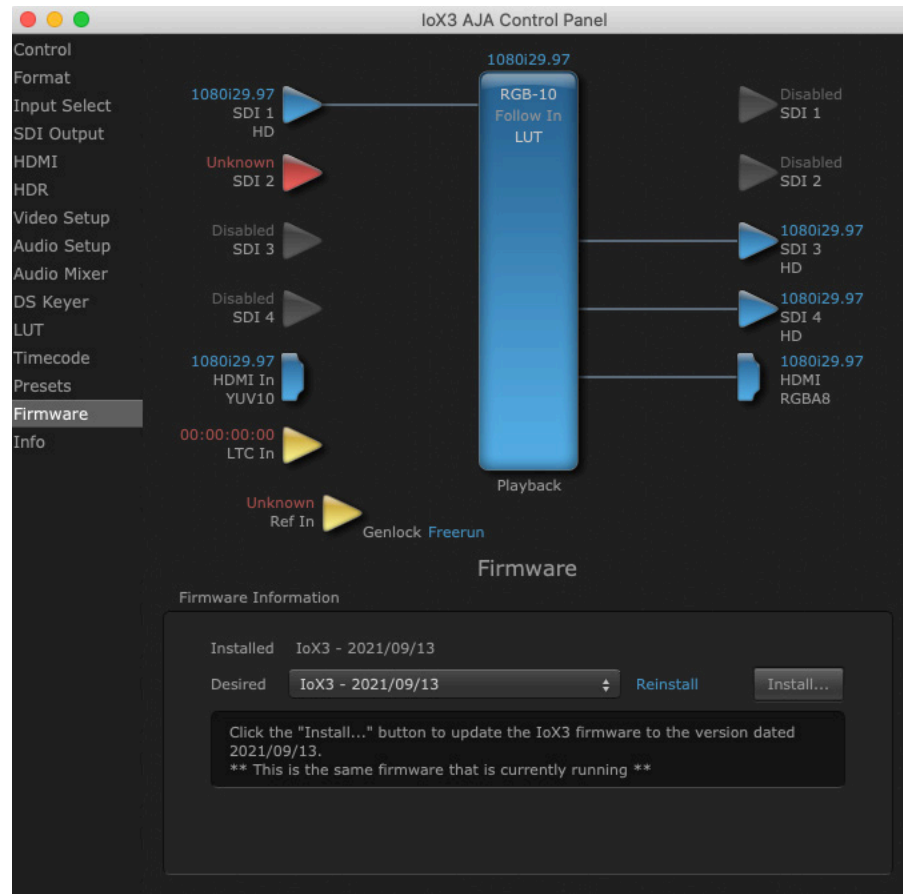

Use the Firmware screen to access the firmware install screen. Click Install to erase current firmware and load the firmware version contained in your current driver installation. Note the Installation message shown below.

Figure 14. Update Completed

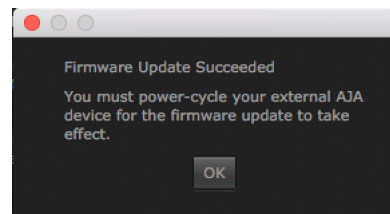

You will be required to power-cycle your Io X3 and computer to finish the update.

Info Screen

The screenshot shows the 'Info' screen of the IoX3 AJA Control Panel. The interface is dark-themed with a sidebar on the left containing menu items: Control, Format, Input Select, SDI Output, HDMI, HDR, Video Setup, Audio Setup, Audio Mixer, DS Keyer, LUT, Timecode, Presets, Firmware, and Info (which is selected). The main area displays a signal flow diagram with various inputs and outputs, including SDI 1-4, HDMI In, and LTC In. A central 'Playback' block is visible. At the bottom, an 'Info' panel provides the following details:

- Hardware ID: IoX3 (0x10920600) S10920600
- Hardware Temperature: 58.1 deg C / 136.5 deg F
- VideoProc Bit file: 2021/09/13 14:11:57 IoX3 Main
- Driver Version: 16.2.0b64
- NTV2 SDK Version: 16.2.0 b64

Two red arrows point to the 'Driver Version' and 'NTV2 SDK Version' fields, which are highlighted with red boxes. The 'Driver Version' field is labeled 'Firmware Version' and the 'NTV2 SDK Version' field is labeled 'SDK Version'.

This screen shows the software files that have been installed on your system. This information may be needed if you talk to an AJA Customer Service representative to determine if files are missing or need updating.

The current firmware and SDK versions for the Io X3 are shown in the fields specified above.

Appendix A – Specifications

Io X3 Tech Specs

Video Formats

- (2K) 2048 x 1080p 23.98, 24, 25, 29.97, 30, 47.95, 48, 50, 59.94, 60
- (2K) 2048 x 1080PsF 23.98, 24, 25
- (HD) 1080p 23.98, 24, 25, 29.97, 30, 50, 59.94, 60
- (HD) 1080PsF 23.98, 24, 25, 29.97, 30
- (HD) 1080i 50, 59.94, 60
- (HD) 720p 50, 59.94, 60
- (SD) 625i 50
- (SD) 525i 59.94

Note: High Frame Rate support is dependent on Thunderbolt speed and system performance. Not all host systems will support all frame rates.

Video Input Digital

- 3G-SDI, SMPTE 425
 - RGB 4:4:4 12-bit*, YCbCr 4:2:2 10-bit
- 1.5G-SDI, SMPTE 292M
 - Single Link HD-SDI YCbCr 4:2:2 10-bit
- 270 Mbps SDI, SMPTE 259M-C
 - YCbCr 4:2:2 10-bit, 8-bit
- HDMI v1.4b
 - 30/36-bits/pixel, RGB or YUV, 2.25 Gbps
 - 2K, HD, and SD

*Bit depth support is application dependent. Check with your software manufacturer for compatibility.

Video Output Digital

- 3G-SDI, SMPTE 425
 - RGB 4:4:4 12-bit*, YCbCr 4:2:2 10-bit
- 1.5G-SDI, SMPTE 292M
 - Single Link HD-SDI YCbCr 4:2:2 10-bit
- 270 Mbps SDI, SMPTE 259M-C
 - YCbCr 4:2:2 10-bit, 8-bit
- HDMI v1.4b
 - 30/36-bits/pixel, RGB or YUV, 2.25 Gbps
 - 2K, HD, and SD

*Bit depth support is application dependent. Check with your software manufacturer for compatibility.

HDR

- SDI: VPID signaling for SDR/HDR Transfer Characteristics
- HDMI: HDR10 Support - HDR Infotone metadata, compatible with HDMI 2.0a/CTA-861.3
- HDMI: HLG Support - compatible with HDMI 2.0b/CTA-861-G

Note: HDR support is application dependent. Check with your software manufacturer for compatibility.

Audio Input Digital

- 16-channel, 16 and 24-bit SMPTE-259 SDI embedded audio, 48 kHz sample rate, synchronous
- 8-channel, 16 and 24-bit HDMI embedded audio, 48 kHz sample rate, synchronous

Audio Output Digital

- 16-channel, 16 and 24-bit SMPTE-259 SDI embedded audio, 48 kHz sample rate, synchronous
- 8-channel, 16 and 24-bit HDMI embedded audio, 48 kHz sample rate, synchronous

Audio Input Analog

- 8-channel, 24 and 16-bit D/A analog audio, 48 kHz sample rate, balanced, using industry standard 8x XLR on DB-25 breakout cable (cable not included)
- +24 dBu full scale digital (0 dBFS)
- +/- 0.2 dB 20 to 20 kHz frequency response
- Input supported across Ch 1-8, Ch 1-4, or Ch 5-8 depending on configuration chosen

Audio Output Analog

- 8-channel, 24-bit D/A analog audio, 48 kHz sample rate, balanced, using industry standard 8x XLR on DB-25 breakout cable (cable not included)
- +24 dBu full scale digital (0 dBFS)
- +/- 0.2 dB 20 to 20 kHz frequency response
- Output supported across Ch 1-8, Ch 1-4, or Ch 5-8 depending on configuration chosen
- 2-channel, 18-bit D/A analog audio, 48 kHz sample rate, unbalanced, using standard 3.5mm jack
 - 1.2V RMS full scale digital output level (0 dBFS)

Downstream Keyer

- Supports graphics up to 2K/HD with alpha channel over video, matte or framebuffer, or framebuffer content over incoming video or matte

LTC

- 1x BNC LTC input (dedicated)
- 1x BNC LTC output (dedicated)

Reference

- 1x BNC (dedicated)
- Analog Color Black (1V) or Composite Sync (2 or 4V)
- Nonterminating

Electrical Interface

- Thunderbolt 3 (2x)

Machine Control

- RS-422, Sony 9-pin protocol
- 9-pin D-connector pinout is as follows:
 - 1 GND
 - 2 RX-
 - 3 TX+
 - 4 GND
 - 5 No Connection
 - 6 GND
 - 7 RX+
 - 8 TX-
 - 9 GND
 - Shell GND

Size (w x d x h)

- 8.25" x 6.28" x 1.66" (209.6 x 159.51 x 42.16 mm)
(inclusive of the BNC connector protrusion and the 'feet').

Weight

- 1.6 lbs. (0.73 kg)

Power

- 10-20V, 23W typical, 28W max

Environment

- Safe Operating Temperature Range: 0 to 35 C (32 to 95 F)
- Safe Storage Temperature (Power OFF): -40 to 60 C (-40 to 140 F)
- Operating Relative Humidity: 10-90% noncondensing
- Operating Altitude: <3,000 meters (<10,000 feet)

Audio Connection Pinouts

Analog Audio

Figure 15. DB-25 Analog Audio Connector Pinouts

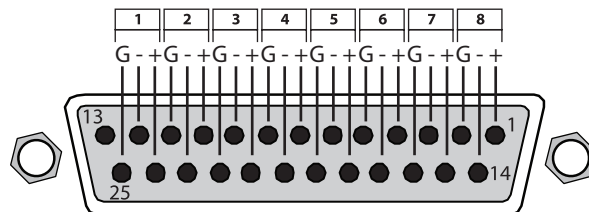

Key
G = Ground
+/- = Balanced Pair

Appendix B – Safety and Compliance

Federal Communications Commission (FCC) Compliance Notices

Class A Interference Statement

This equipment has been tested and found to comply with the limits for a Class A digital device, pursuant to Part 15, Subpart B of the FCC Rules. These limits are designed to provide reasonable protection against harmful interference in a residential installation. This equipment generates, uses, and can radiate radio frequency energy and, if not installed and used in accordance with the instructions, may cause harmful interference to radio communications. However, there is no guarantee that interference will not occur in a particular installation. If this equipment does cause harmful interference to radio or television reception, which can be determined by turning the equipment off and on, the user is encouraged to try to correct the interference by one or more of the following measures:

- Reorient or relocate the receiving antenna.
- Increase the separation between the equipment and receiver.
- Connect the equipment into an outlet on a circuit different from that to which the receiver is connected.
- Consult the dealer or an experienced radio/TV technician for help.

FCC Caution

This device complies with Part 15 of the FCC Rules. Operation is subject to the following two conditions: (1) This device may not cause harmful interference, and (2) this device must accept any interference received, including interference that may cause undesired operation.

Canadian ICES Statement

Canadian Department of Communications Radio Interference Regulations

This digital apparatus does not exceed the Class A limits for radio-noise emissions from a digital apparatus as set out in the Radio Interference Regulations of the Canadian Department of Communications. This Class A digital apparatus complies with Canadian ICES-003.

Règlement sur le brouillage radioélectrique du ministère des Communications

Cet appareil numérique respecte les limites de bruits radioélectriques visant les appareils numériques de classe A prescrites dans le Règlement sur le brouillage radioélectrique du ministère des Communications du Canada. Cet appareil numérique de la Classe A est conforme à la norme NMB-003 du Canada.

European Union, European Free Trade Association (EFTA) and United Kingdom Regulatory Compliance

This equipment may be operated in the countries that comprise the member countries of the European Union, European Free Trade Association and the United Kingdom. These countries, listed in the following paragraph, are referred to as The European Community throughout this document:

AUSTRIA, BELGIUM, BULGARIA, CROATIA, CZECH REPUBLIC, DENMARK, ESTONIA, FINLAND, FRANCE, GERMANY, GREECE, HUNGARY, ICELAND, IRELAND, ITALY, LATVIA, LIECHTENSTEIN, LITHUANIA, LUXEMBOURG, MALTA, NETHERLANDS, NORWAY, POLAND, PORTUGAL, REPUBLIC OF CYPRUS, ROMANIA, SLOVAK REPUBLIC, SLOVENIA, SPAIN, SWEDEN, SWITZERLAND, UNITED KINGDOM

Declaration of Conformity

Marking by this symbol indicates compliance with the Essential Requirements of the EMC Directive of the European Union 2014/30/EU.



This equipment meets the following conformance standards:

Safety

EN 62368-1: 2014 + A11 (T-Mark License)

IEC 62368-1: 2014, IEC 62368-1 : 2018 (CB Scheme Report/Certificate)

Emissions

EN 55032: 2015 + A11: 2020, CISPR 32: 2015,

EN 61000-3-2: 2019 + A1: 2021 + A2: 2024, EN 61000-3-3: 2013 + A2: 2021
+ AC: 2022

Immunity

EN 55035: 2017 + A11: 2020, CISPR 35: 2016, EN 61000-4-2: 2025,

EN 61000-4-3: 2020, EN 61000-4-4: 2012, EN 61000-4-5: 2014 + A1: 2017,

EN 61000-4-6: 2023, EN 61000-4-8: 2010, EN 61000-4-11: 2020 + AC: 2022

The product is also licensed, as required, for additional country specific standards for the International Marketplace.



Warning! This is a Class A product. In a domestic environment, this product may cause radio interference, in which case, the user may be required to take appropriate measures.

Achtung! Dieses ist ein Gerät der Funkstörgrenzwertklasse A. In Wohnbereichen können bei Betrieb dieses Gerätes Rundfunkstörungen auftreten, in welchen Fällen der Benutzer für entsprechende Gegenmaßnahmen verantwortlich ist.

Attention! Ceci est un produit de Classe A. Dans un environnement domestique, ce produit risque de créer des interférences radioélectriques, il appartiendra alors à l'utilisateur de prendre les mesures spécifiques appropriées.

Recycling Notice



This symbol on the product or its packaging indicates that this product must not be disposed of with your other household waste. Instead, it is your responsibility to dispose of your waste equipment by handing it over to a designated collection point for the recycling of waste electrical and electronic equipment. The separate collection and recycling of your waste equipment at the time of disposal will help conserve natural resources and ensure that it is recycled in a manner that protects human health and the environment. For more information about where you can drop off your waste for recycling, please contact your local authority, or where you purchased your product.

Korea KCC Compliance Statement

사 용 자 안 내 문

이 기기는 업무용 환경에서 사용할 목적으로 적합성평가를 받은 기기로서 가정용 환경에서 사용하는 경우 전파간섭의 우려가 있습니다.

Taiwan Compliance Statement

警告使用者：
這是甲類的資訊產品，在居住的環境中使用時，可能會造成射頻干擾，在這種情況下，使用者會被要求採取某些適當的對策。

This is a Class A product based on the standard of the Bureau of Standards, Metrology and Inspection (BSMI) CNS 15936: 2016, Class A. In a domestic environment this product may cause radio interference in which case the user may be required to take adequate measures.

Japan Compliance Statement

この装置は、クラスA情報技術装置です。この装置を家庭環境で使用すると電波妨害を引き起こすことがあります。この場合には使用者が適切な対策を講ずるよう要求されることがあります。 VCCI-A

This is a Class A product based on the standard of the VCCI Council (VCCI 32: 2016). If this equipment is used in a domestic environment, radio interference may occur, in which case, the user may be required to take corrective actions.

Chinese Compliance Statement

This product has been tested to the following Chinese standards:

GB 17625.1-2022;GB 4943.1-2022;GB/T 9254.1-2021(Class A)

This is to certify that the above mentioned product(s) complies with the requirements of certification rules of CQC12-045800-2022 under certificate number CQC2012010805541543.

Translated Warning and Caution Messages

The following caution statements, warning conventions, and warning messages apply to this product and manual.



Warning Symbol



Caution Symbol

Before Operation Please Read These Instructions



Warning! Read and follow all warning notices and instructions marked on the product or included in the documentation.

Avertissement! Lisez et conformez-vous à tous les avis et instructions d'avertissement indiqués sur le produit ou dans la documentation.

Warnung! Lesen und befolgen Sie die Warnhinweise und Anweisungen, die auf dem Produkt angebracht oder in der Dokumentation enthalten sind.

¡Advertencia! Lea y siga todas las instrucciones y advertencias marcadas en el producto o incluidas en la documentación.

Aviso! Leia e siga todos os avisos e instruções assinalados no produto ou incluídos na documentação.

Avviso! Leggere e seguire tutti gli avvisi e le istruzioni presenti sul prodotto o inclusi nella documentazione.



Warning! Do not use this device near water and clean only with a dry cloth.

Avertissement! N'utilisez pas cet appareil près de l'eau et nettoyez-le seulement avec un tissu sec.

Warnung! Das Gerät nicht in der Nähe von Wasser verwenden und nur mit einem trockenen Tuch säubern.

¡Advertencia! No utilice este dispositivo cerca del agua y límpielo solamente con un paño seco.

Aviso! Não utilize este dispositivo perto da água e limpe-o somente com um pano seco.

Avviso! Non utilizzare questo dispositivo vicino all'acqua e pulirlo soltanto con un panno asciutto.



Warning! Do not block any ventilation openings. Install in accordance with the manufacturer's instructions.

Avertissement! Ne bloquez aucune ouverture de ventilation. Suivez les instructions du fabricant lors de l'installation.

Warnung! Die Lüftungsöffnungen dürfen nicht blockiert werden. Nur gemäß den Anweisungen des Herstellers installieren.

¡Advertencia! No bloquee ninguna de las aberturas de la ventilación. Instale de acuerdo con las instrucciones del fabricante.

Aviso! Não obstrua nenhuma das aberturas de ventilação. Instale de acordo com as instruções do fabricante.

Avviso! Non ostruire le aperture di ventilazione. Installare in conformità con le istruzioni del fornitore.



Warning! Do not install near any heat sources such as radiators, heat registers, stoves, or other apparatus (including amplifiers) that produce heat.

Avertissement! N'installez pas l'appareil près d'une source de chaleur telle que des radiateurs, des bouches d'air de chauffage, des fourneaux ou d'autres appareils (amplificateurs compris) qui produisent de la chaleur.

Warnung! Nicht in der Nähe von Wärmequellen wie Heizkörpern, Heizregistern, Öfen oder anderen Wärme erzeugenden Geräten (einschließlich Verstärkern) aufstellen.

¡Advertencia! No instale cerca de fuentes de calor tales como radiadores, registros de calor, estufas u otros aparatos (incluidos amplificadores) que generan calor.

Aviso! Não instale perto de nenhuma fonte de calor tal como radiadores, saídas de calor, fogões ou outros aparelhos (incluindo amplificadores) que produzam calor.

Avviso! Non installare vicino a fonti di calore come termosifoni, diffusori di aria calda, stufe o altri apparecchi (amplificatori compresi) che emettono calore.



Warning! Unplug this device during lightning storms or when unused for long periods of time.

Avertissement! Débranchez cet appareil pendant les orages avec éclairs ou s'il est inutilisé pendant de longues périodes.

Warnung! Das Gerät ist bei Gewitterstürmen oder wenn es über lange Zeiträume ungenutzt bleibt vom Netz zu trennen.

¡Advertencia! Desenchufe este dispositivo durante tormentas eléctricas o cuando no se lo utilice por largos periodos del tiempo.

Aviso! Desconecte este dispositivo da tomada durante trovoadas ou quando não é utilizado durante longos períodos de tempo.

Avviso! Utilizzare soltanto i collegamenti e gli accessori specificati e/o venduti dal produttore, quali il treppiedi e l'esoscheletro.



Warning! Do not open the chassis. There are no user-serviceable parts inside. Opening the chassis will void the warranty unless performed by an AJA service center or licensed facility.

Avertissement! Ne pas ouvrir le châssis. Aucun élément à l'intérieur du châssis ne peut être réparé par l'utilisateur. La garantie sera annulée si le châssis est ouvert par toute autre personne qu'un technicien d'un centre de service ou d'un établissement agréé AJA.

Warnung! Öffnen Sie das Gehäuse nicht. Keine der Geräteteile können vom Benutzer gewartet werden. Durch das Öffnen des Gehäuses wird die Garantie hinfällig, es sei denn, solche Wartungsarbeiten werden in einem AJA-Service-Center oder einem lizenzierten Betrieb vorgenommen.

¡Advertencia! No abra el chasis. El interior no contiene piezas reparables por el usuario. El abrir el chasis anulará la garantía a menos que se lo haga en un centro de servicio AJA o en un local autorizado.

Advertência! Não abra o chassi. Não há internamente nenhuma peça que permita manutenção pelo usuário. Abrir o chassi anula a garantia, a menos que a abertura seja realizada por uma central de serviços da AJA ou por um local autorizado.

Avvertenza! Non aprire lo chassis. All'interno non ci sono parti riparabili dall'utente. L'apertura dello chassis invaliderà la garanzia se non viene effettuata da un centro ufficiale o autorizzato AJA.



Warning! Only use attachments and accessories specified and/or sold by the manufacturer.

Avertissement! Utilisez seulement les attaches et accessoires spécifiés et/ou vendus par le fabricant.

Warnung! Verwenden Sie nur Zusatzgeräte und Zubehör angegeben und / oder verkauft wurde durch den Hersteller.

¡Advertencia! Utilice solamente los accesorios y conexiones especificados y/o vendidos por el fabricante.

Aviso! Utilize apenas equipamentos/acessórios especificados e/ou vendidos pelo fabricante.

Avviso! Utilizzare soltanto i collegamenti e gli accessori specificati e/o venduti dal produttore.



Warning! Refer all servicing to qualified service personnel. Servicing is required when the device has been damaged in any way, such as power-supply cord or plug is damaged, liquid has been spilled or objects have fallen into the device, the device has been exposed to rain or moisture, does not operate normally, or has been dropped.

Avertissement! Référez-vous au personnel de service qualifié pour tout entretien. L'entretien est exigé quand l'appareil a été endommagé de quelque manière que ce soit, par exemple lorsque le cordon d'alimentation ou la prise sont endommagés, que du liquide a été versé ou des objets sont tombés dans l'appareil, que l'appareil a été exposé à la pluie ou à l'humidité, ne fonctionne pas normalement ou est tombé.

Warnung! Das Gerät sollte nur von qualifizierten Fachkräften gewartet werden. Eine Wartung ist fällig, wenn das Gerät in irgendeiner Weise beschädigt wurde, wie bei beschädigtem Netzkabel oder Netzstecker, falls Flüssigkeiten oder Objekte in das Gerät gelangen, das Gerät Regen oder Feuchtigkeit ausgesetzt wurde, nicht ordnungsgemäß funktioniert oder fallen gelassen wurde.

¡Advertencia! Consulte al personal calificado por cuestiones de reparación. El servicio de reparación se requiere cuando el dispositivo ha recibido cualquier tipo de daño, por ejemplo cable o espigas dañadas, se ha derramado líquido o se han caído objetos dentro del dispositivo, el dispositivo ha sido expuesto a la lluvia o humedad, o no funciona de modo normal, o se ha caído.

Aviso! Remeta todos os serviços de manutenção para o pessoal de assistência qualificado. A prestação de serviços de manutenção é exigida quando o dispositivo foi danificado mediante qualquer forma, como um cabo de alimentação ou ficha que se encontra danificado/a, quando foi derramado líquido ou caíram objectos sobre o dispositivo, quando o dispositivo foi exposto à chuva ou à humidade, quando não funciona normalmente ou quando foi deixado cair.

Avviso! Fare riferimento al personale qualificato per tutti gli interventi di assistenza. L'assistenza è necessaria quando il dispositivo è stato danneggiato in qualche modo, ad esempio se il cavo di alimentazione o la spina sono danneggiati, è stato rovesciato del liquido è stato rovesciato o qualche oggetto è caduto nel dispositivo, il dispositivo è stato esposto a pioggia o umidità, non funziona correttamente o è caduto.



Warning! Do not defeat the safety purpose of the polarized or grounding-type plug. A polarized plug has two blades with one wider than the other. A grounding type plug has two blades and a third grounding prong. The wide blade or the third prong are provided for your safety. If the provided plug does not fit into your outlet, consult an electrician for replacement of the obsolete outlet.

Avertissement! La sécurité de la prise polarisée ou de la prise de type mise à la terre ne doit en aucun cas être empêchée de fonctionner. Une prise polarisée a deux broches, l'une étant plus large que l'autre. Une prise de type mise à la terre a deux broches et une troisième broche pour la mise à la terre. La broche large ou la troisième broche sont fournies pour votre sécurité. Si la prise fournie ne s'insère pas dans votre prise femelle, consultez un électricien pour le remplacement de la prise femelle obsolète.

Warnung! Der Sicherheitszweck des gepolten bzw. Schukosteckers ist zu berücksichtigen. Ein gepolter Stecker verfügt über zwei Pole, von denen einer breiter als der andere ist. Ein Schukostecker verfügt neben den zwei Polen noch über einen dritten Pol zur Erdung. Der breite Pol bzw. der Erdungspol dienen der Sicherheit. Wenn der zur Verfügung gestellte Stecker nicht in Ihren Anschluss passt, konsultieren Sie einen Elektriker, um den veralteten Anschluss zu ersetzen.

¡Advertencia! No eche por tierra la finalidad del tipo de enchufe polarizado con conexión a tierra. Un enchufe polarizado tiene dos espigas, una más ancha que la otra. Un enchufe con conexión a tierra tiene dos espigas iguales y una tercera espiga que sirve para la conexión a tierra. La espiga ancha, o la tercera espiga, sirven para su seguridad. Si el enchufe suministrado no encaja en el tomacorriente, consulte con un electricista para reemplazar el tomacorriente obsoleto.

Aviso! Não anule a finalidade da segurança da ficha polarizada ou do tipo ligação terra. Uma ficha polarizada tem duas lâminas sendo uma mais larga do que a outra. Uma ficha do tipo de ligação à terra tem duas lâminas e um terceiro terminal de ligação à terra. A lâmina larga ou o terceiro terminal são fornecidos para sua segurança. Se a ficha fornecida não couber na sua tomada, consulte um electricista para a substituição da tomada obsoleta.

Avviso! Non compromettere la sicurezza della spina polarizzata o con messa a terra. Una spina polarizzata ha due spinotti, di cui uno più largo. Una spina con messa a terra ha due spinotti e un terzo polo per la messa a terra. Lo spinotto largo o il terzo polo sono forniti per motivi di sicurezza. Se la spina fornita non si inserisce nella presa di corrente, contattare un elettricista per la sostituzione della presa obsoleta.



Warning! Disconnect the external AC power supply line cord(s) from the mains power before moving the unit.

Avertissement! Retirez le ou les cordons d'alimentation en CA de la source d'alimentation principale lorsque vous déplacez l'appareil.

Warnung! Trennen Sie die Wechselstrom-Versorgungskabel vom Netzstrom, bevor Sie das Gerät verschieben.

¡Advertencia! Cuando mueva la unidad desenchufe de la red eléctrica el/los cable(s) de la fuente de alimentación CA tipo brick.

Advertência! Remova os cabos CA de alimentação brick da rede elétrica ao mover a unidade.

Avvertenza! Scollegare il cavo dell'alimentatore quando si sposta l'unità.



Warning! Since the Mains plug is used as the disconnection for the device, it must remain readily accessible and operable.

Avertissement! Puisque la prise principale est utilisée pour débrancher l'appareil, elle doit rester aisément accessible et fonctionnelle.

Warnung! Da der Netzstecker als Trennvorrichtung dient, muss er stets zugänglich und funktionsfähig sein.

¡Advertencia! Puesto que el enchufe de la red eléctrica se utiliza como dispositivo de desconexión, debe seguir siendo fácilmente accesible y operable.

Aviso! Dado que a ficha principal é utilizada como a desconexão para o dispositivo, esta deve manter-se prontamente acessível e funcional.

Avviso! Poiché il cavo di alimentazione viene usato come dispositivo di sconnessione, deve rimanere prontamente accessibile e operabile.



Warning! Protect the power cord from being walked on or pinched particularly at plugs, convenience receptacles, and the point where they exit from the device.

Avertissement! Protégez le cordon d'alimentation pour que l'on ne marche pas dessus ou qu'on le pince, en particulier au niveau des prises mâles, des réceptacles de convenance, et à l'endroit où il sort de l'appareil.

Warnung! Vermeiden Sie, dass auf das Netzkabel getreten oder das Kabel geknickt wird, insbesondere an den Steckern, den Steckdosen und am Kabelausgang am Gerät.

¡Advertencia! Proteja el cable de corriente para que no se le pise ni apriete, en especial cerca del enchufe, los receptáculos de conveniencia y el punto del que salen del equipo.

Aviso! Proteja o cabo de alimentação de ser pisado ou de ser comprimido particularmente nas fichas, em tomadas de parede de conveniência e no ponto de onde sai do dispositivo.

Avviso! Proteggere il cavo di alimentazione in modo che nessuno ci cammini sopra e che non venga schiacciato soprattutto in corrispondenza delle spine e del punto in cui esce dal dispositivo.

3 Year Warranty and Liability Information

Limited Warranty on Hardware

AJA Video Systems, Inc. (AJA Video) warrants that the hardware product, not including storage modules or software components, will be free from defects in materials and workmanship for a period of three years from the date of purchase. AJA Video warrants that the storage modules provided as part of the hardware product will be free from defects in materials and workmanship for a period of one year from the date of purchase. AJA Video provides a separate software warranty as part of the license agreement applicable to software components.

If the Customer brings a valid claim under this limited warranty for a hardware product or storage module (hereafter, a "product") during the applicable warranty period, AJA Video will, at its sole option and as the Customer's sole remedy for breach of the above warranty, provide one of the following remedies:

- Repair or facilitate the repair the product within a reasonable period of time, free of charge for parts and labor.
- Replace the product with a direct replacement or with a product that performs substantially the same function as the original product.
- Issue a refund of the original purchase price less depreciation to be determined based on the age of the product at the time remedy is sought under this limited warranty.

To obtain service under this warranty, the Customer must notify AJA Video of the defect before expiration of the warranty period and make suitable arrangements for the performance of service by contacting AJA Video support through the channels set forth on the support contacts web page at <https://www.aja.com/support>.

Except as stated, the Customer shall bear all shipping, packing, insurance and other costs, excluding parts and labor, to effectuate repair. Customer shall pack and ship the defective product to a service center designated by AJA Video, with shipping charges prepaid. AJA Video shall pay to return the product to Customer, but only if to a location within the country in which the AJA Video service center is located. SOME JURISDICTIONS DO NOT ALLOW THE EXCLUSION OF IMPLIED WARRANTIES OR LIMITATIONS ON APPLICABLE STATUTORY RIGHTS OF A CONSUMER, SO SOME OR ALL OF THE TERMS OF THIS PARAGRAPH MAY NOT APPLY TO YOU.

Limitation of Liability

Under no circumstances shall AJA video BE LIABLE IN ANY WAY FOR ANY LOST, CORRUPTED OR DESTROYED DATA, FOOTAGE OR WORK, OR FOR ANY OTHER INDIRECT, SPECIAL, INCIDENTAL OR CONSEQUENTIAL DAMAGES OR LOST PROFITS, OR FOR ANY THIRD PARTY CLAIM, IN CONNECTION WITH THE PRODUCT, WHETHER RESULTING FROM DEFECTS IN THE PRODUCT, SOFTWARE OR HARDWARE FAILURE, OR ANY OTHER CAUSE WHATSOEVER, EVEN IF AJA VIDEO HAS BEEN ADVISED OF THE POSSIBILITY OF SUCH DAMAGES. AJA VIDEO'S LIABILITY IN CONNECTION WITH THE PRODUCT SHALL UNDER NO CIRCUMSTANCES EXCEED THE PURCHASE PRICE PAID FOR THE PRODUCT. The foregoing limitations apply even if any remedy set forth in this LIMITED WARRANTY fails of its essential purpose. SOME JURISDICTIONS DO NOT ALLOW THE LIMITATION OF LIABILITY FOR PERSONAL INJURY, OR OF INCIDENTAL OR CONSEQUENTIAL DAMAGES, SO SOME OR ALL OF THE TERMS OF THIS PARAGRAPH MAY NOT APPLY TO YOU.

Governing Law and Language; Your Rights

This limited warranty is the only warranty provided by AJA Video on the hardware product. It supersedes all prior or contemporaneous understandings regarding such subject matter. No amendment to or modification of this warranty will be binding unless in writing and signed by AJA Video. The laws of the State of California, USA will govern this warranty and any dispute arising from it. Any translation of this Agreement is intended for convenience and to meet local requirements and in the event of a dispute between the English and any non-English versions, the English version of this warranty will govern. This limited warranty gives you specific legal rights and you may have other rights that vary from jurisdiction to jurisdiction, some of which are noted above.

AJA Software License Agreement

AJA VIDEO SYSTEMS, INC.

THIS IS AN AGREEMENT BETWEEN YOU AND AJA VIDEO SYSTEMS, INC. ("AJA") THAT GOVERNS YOUR USE OF the software ACCOMPANYING THIS LICENSE (E.G., AS installed on the device with which this license is provided).

The "AJA Software" referenced in this Agreement includes all such software, whether made available to you on disk, in read only memory, on any other media or in any other form, and all updates, corrections, enhancements and new versions of such software made available by AJA, together with all related documentation. BY INSTALLING OR USING THE AJA SOFTWARE, YOU ARE AGREEING TO BE BOUND BY THE TERMS OF THIS AGREEMENT. IF YOU DO NOT AGREE TO THE TERMS OF THIS AGREEMENT, DO NOT INSTALL OR USE IT AND, IF APPLICABLE, RETURN THE AJA SOFTWARE TO THE PLACE WHERE YOU OBTAINED IT FOR A REFUND.

1. License Grant. AJA hereby grants you a nonexclusive, personal, non-sublicenseable and limited license to install and use AJA Software on a computer or AJA device. The foregoing license also includes the right to make copies of the AJA Software in machine-readable form for installation and backup purposes only, and provided that each copy you make must include all copyright or other proprietary notices contained on the original.

2. Limitations. You may not decompile, reverse engineer, disassemble, modify, or create derivative works of the AJA Software or any part thereof except to the extent (if any) authorized by applicable law notwithstanding the foregoing restriction. You may not rent, lease, lend, loan, distribute or act as a service bureau or "cloud service" provider with respect to use of the AJA Software or any functionality thereof. THE AJA SOFTWARE IS NOT INTENDED FOR USE IN THE OPERATION OF NUCLEAR FACILITIES, AIRCRAFT NAVIGATION OR COMMUNICATION SYSTEMS, AIR TRAFFIC CONTROL SYSTEMS, LIFE SUPPORT MACHINES OR OTHER EQUIPMENT IN WHICH THE FAILURE OF THE AJA SOFTWARE COULD LEAD TO DEATH, PERSONAL INJURY, OR SEVERE PHYSICAL OR ENVIRONMENTAL DAMAGE.

3. Reservation of Rights. The AJA Software is protected by law, including without limitation copyright law. The AJA Software is licensed, not sold, to you. AJA and its licensors reserve all rights not expressly granted to you by this Agreement. You own the media on which the AJA Software is recorded but AJA and/or AJA's licensor(s) retain ownership of the AJA Software itself. You may not use the AJA Software for any illegal purpose.

4. Transfer. You may make a one-time permanent transfer of all of your license rights to the AJA Software to another person or entity, provided that: (a) you transfer all of the AJA Software, including all its component parts, original media, printed materials and this Agreement; (b) you do not retain any copies of the AJA Software, including any copies stored on a computer or other device; and (c) you transfer the AJA Software subject to this Agreement, and the person or entity receiving the AJA Software accepts the terms and conditions of this Agreement.

5. NFR (Not for Resale) Copies and Add-On Features: Notwithstanding anything to the contrary in this Agreement, (a) AJA Software that is labeled "Not for Resale" or otherwise provided to you on a promotional or demonstration basis may be used only for your demonstration, testing and evaluation purposes and may not be resold or transferred; and (b) AJA may make available certain software components ("Add-On Features") under separate terms and conditions, in which case those separate terms and conditions apply and the Add-On Features are not considered AJA Software under this Agreement.

6. Termination. Your rights in the AJA Software are conditioned on complying with this Agreement, and those rights (together with this Agreement) will terminate automatically, without notice from AJA, if you fail to comply with any term(s) of this Agreement. Upon termination of this Agreement, you must cease all use of the AJA Software and destroy all copies, full or partial, of the AJA Software in your possession or control.

7. Limited Warranty on AJA Software. If you comply with all terms of this Agreement and use the AJA Software in accordance with its documentation, and you install any patches or other updates made available to the AJA Software by AJA, AJA warrants that the AJA Software will perform substantially in accordance with its documentation for a period of ninety (90) days from the date of your original retail purchase. Your exclusive remedy under this warranty will be, at AJA's option, a refund of the purchase

price of the product containing the AJA Software or an update to or replacement of the AJA Software (or applicable component of it). THIS LIMITED WARRANTY AND ANY IMPLIED WARRANTIES ON THE AJA SOFTWARE INCLUDING, BUT NOT LIMITED TO, ANY WARRANTIES OF MERCHANTABILITY, OF SATISFACTORY QUALITY, OR OF FITNESS FOR A PARTICULAR PURPOSE, ARE LIMITED IN DURATION TO NINETY (90) DAYS FROM THE DATE OF ORIGINAL RETAIL PURCHASE. SOME JURISDICTIONS DO NOT ALLOW LIMITATIONS ON HOW LONG A WARRANTY LASTS, SO THE ABOVE LIMITATION MAY NOT APPLY TO YOU. THIS LIMITED WARRANTY GIVES YOU SPECIFIC LEGAL RIGHTS, AND YOU MAY ALSO HAVE OTHER RIGHTS WHICH VARY BY JURISDICTION.

8. Disclaimer of Other Warranties on Aja Software. EXCEPT FOR THE LIMITED WARRANTY ON AJA SOFTWARE SET FORTH ABOVE, AJA AND AJA'S LICENSORS (COLLECTIVELY REFERRED TO AS "AJA" FOR THE PURPOSES OF SECTIONS 8 AND 9) HEREBY DISCLAIM ALL WARRANTIES AND CONDITIONS WITH RESPECT TO THE AJA SOFTWARE, WHETHER EXPRESS, IMPLIED OR STATUTORY, INCLUDING, BUT NOT LIMITED TO, THE IMPLIED WARRANTIES AND/OR CONDITIONS OF MERCHANTABILITY, OF SATISFACTORY QUALITY, OF FITNESS FOR A PARTICULAR PURPOSE, OF ACCURACY, AND OF QUIET ENJOYMENT. FURTHER, AJA DOES NOT MAKE ANY WARRANTY REGARDING NON-INFRINGEMENT OF THIRD PARTY RIGHTS. SUBJECT ONLY TO THE LIMITED WARRANTY SET FORTH IN SECTION 7, YOU EXPRESSLY ACKNOWLEDGE AND AGREE THAT USE OF THE AJA SOFTWARE IS AT YOUR SOLE RISK. AJA DOES NOT WARRANT AGAINST INTERFERENCE WITH YOUR ENJOYMENT OF THE AJA SOFTWARE, THAT THE AJA SOFTWARE WILL MEET YOUR REQUIREMENTS, THAT THE OPERATION OF THE AJA SOFTWARE WILL BE UNINTERRUPTED OR ERROR-FREE, OR THAT DEFECTS IN THE AJA SOFTWARE WILL BE CORRECTED. NO ORAL OR WRITTEN INFORMATION OR ADVICE GIVEN BY AJA OR AN AJA AUTHORIZED REPRESENTATIVE WILL CREATE A WARRANTY. SOME JURISDICTIONS DO NOT ALLOW THE EXCLUSION OF IMPLIED WARRANTIES OR LIMITATIONS ON APPLICABLE STATUTORY RIGHTS OF A CONSUMER, SO SOME OR ALL OF THE TERMS OF THIS PARAGRAPH MAY NOT APPLY TO YOU.

9. Limitation of Liability. TO THE EXTENT NOT PROHIBITED BY LAW, IN NO EVENT WILL AJA BE LIABLE FOR PERSONAL INJURY, OR ANY INCIDENTAL, SPECIAL, INDIRECT OR CONSEQUENTIAL DAMAGES OR LOST PROFITS WHATSOEVER, INCLUDING, WITHOUT LIMITATION, DAMAGES FOR LOSS OF DATA, BUSINESS INTERRUPTION OR ANY OTHER COMMERCIAL DAMAGES OR LOSSES, ARISING OUT OF OR RELATED TO YOUR USE OR INABILITY TO USE THE AJA SOFTWARE, HOWEVER CAUSED, REGARDLESS OF THE THEORY OF LIABILITY (E.G., WHETHER UNDER CONTRACT, TORT OR OTHERWISE) AND EVEN IF AJA HAS BEEN ADVISED OF THE POSSIBILITY OF SUCH DAMAGES. In no event will AJA's total liability to you for all damages (INCLUDING WITHOUT LIMITATION BREACH OF WARRANTY) exceed the amount of fifty dollars (\$50.00). The foregoing limitations will apply even if the any remedy set forth in this agreement fails of its essential purpose. SOME JURISDICTIONS DO NOT ALLOW THE LIMITATION OF LIABILITY FOR PERSONAL INJURY, OR OF INCIDENTAL OR CONSEQUENTIAL DAMAGES, SO SOME OR ALL OF THE TERMS OF THIS PARAGRAPH MAY NOT APPLY TO YOU.

10. Export Law Assurances. You may not use or otherwise export or reexport the AJA Software except as authorized by United States law and the laws of the jurisdiction in which the AJA Software was obtained. In particular, but without limitation, the AJA Software may not be exported or re-exported (a) into (or to a national or resident of) any U.S. embargoed countries, or (b) to anyone on the U.S. Treasury Department's list of Specially Designated Nationals or the U.S. Department of Commerce Denied Persons List or Entity List or any similar legal designation. By using the AJA Software, you represent and warrant that you are not located in, under control of, or a national or resident of any such country or on any such list.

11. Government End Users. The AJA Software including its documentation is a "Commercial Item", as that term is defined at 48 C.F.R. § 2.101, consisting of "Commercial Computer Software" and "Commercial Computer Software Documentation", as such terms are used in 48 C.F.R. § 12.212 or 48 C.F.R. § 227.7202 (or their successors), as applicable. Consistent with these provisions, the AJA Software is licensed to U.S. Government end users (a) only as a Commercial Item and (b) with only those rights as are granted to all other end users pursuant to this Agreement. Unpublished-rights reserved under the copyright laws of the United States.

12. Controlling Law and Severability. This Agreement will be governed by and construed in accordance with the laws of the State of California, as applied to agreements entered into and to be performed entirely within California between California residents. This Agreement will not be governed by the United Nations

Convention on Contracts for the International Sale of Goods, the application of which is expressly excluded. If for any reason a court of competent jurisdiction finds any provision, or portion thereof, to be unenforceable, the remainder of this Agreement will continue in full force and effect.

13. Complete Agreement; Governing Language. This Agreement constitutes the entire agreement between the parties with respect to the use of the AJA Software licensed hereunder and supersedes all prior or contemporaneous understandings regarding such subject matter. No amendment to or modification of this Agreement will be binding unless in writing and signed by AJA. Any translation of this Agreement is intended for convenience and to meet local requirements and in the event of a dispute between the English and any non-English versions, the English version of this Agreement will govern.

Index

Symbols

- 3G Transport 28
- 3 Year Warranty and Liability Information 62
- 12V Power Connector 11

A

- AJA Agent is not running 17
 - Restart Services 17
- AJA Control Panel 6, 12
 - User Interface 14
- AJA Control Room 6, 12
- AJA Input 39
- AJA Software License Agreement 63
- AJA Software & Utilities 6
- AJA Support 2
- AJA System Test 6, 12
- Alpha Channel 42
- Analog Audio 11
- Analog Audio Monitor Level 36
- Analog Audio Pinouts 53
- Ancillary Data 35
- Audio Ch 29
- Audio Ch 3/4 Swap 30, 31
- Audio Input 26
- Audio Level Meters 13
- Audio Mixer Screen 36
- Audio Monitor 35
- Audio Monitoring 20
- Audio Monitoring Routing Diagram 21
- Audio Out 42
- Audio Setup Screen 35

B

- Black Burst 10
- Block Diagram Area 15

C

- Cable Connections 9
- Capture Mode 14
- Capture Monitor Mode Screen 38
- Ch 3/4 Swap 30
- Ch Map 26
- Colorimetry 32
- Color Space 27, 30, 34
- Controlling Application 17
- Controlling Application Format Selection 17
- Control Panel 6, 12
 - Framebuffer 16
 - Input/Output Icon 16
 - UI Colors 16
 - User Interface 14
- Control Panel Restart Services 17
- Control Room 6, 12
- Control Screen 22

- Cross-Conversion 25
- Custom LUT Controls 43

D

- DE-9 Connector 10
- Default Preferences 18
- Default State 22
- Delete Preset 48
- Device Format 16
- Digital Primaries 33
- Display Mastering Luminance 33
- Downstream Keyer 41
- DS Keyer Screen 41

E

- Erase all Prefs 48
- Export 44

F

- Fan Settings 23
- Features 5
- Firmware Screen 49
- Follow Input 25
- Foreground Pre-Multiplied 42
- Format Screen 24
- Frame Buffer Over Matte 42
- Frame Buffer Over Video In 42
- Freerun 23

G

- Gamma 35
- Genlock Source 23
- Global Preference 19
- Global Preference File Location 19
- Graphic File 42
- Graphic File Display 23
- Graphic Over Frame Buffer 42
- Graphic Over Matte 42
- Graphic over Video In 42

H

- HDMI Input 10, 31
- HDMI Output 10, 29
- HDMI Screen 29
 - 4K Mode 51
- HDR Capture 32
- HDR Mode 33
- HDR Playback 32
- HDR Screen 31
- Hold Last App 22
- Horiz and Vert Timing 23
- Host Audio 40

I

- Info Screen 50
- Input/Output Icon 16

- Input/Output Icons 16
- Input Select Screen 25
- Installation Overview 9

K

- Keyed Video 42
- Keyer
 - Downstream 41

L

- Load Preset 48
- Local Preference 18
- Local Preference File 18
- LTC Input 10
- LTC Output 10
- Luminance 33
- LUT File 45
- LUT File Format Specification 45
- LUT Gain and Offset Controls 44
- LUT Screen 43
- LUT Type 43

M

- Machine Control 10
- macOS, Windows and Linux Packages 12
- Main App 39
- Matte Color 42
- Maximum Content Light Level (CLL) 33
- Maximum Frame Average Light Level (FALL) 33
- Modes of Operation 14
- Monitor Gain Control 13
- Monitor Output 13
- MultiView 5, 29

O

- Operating Modes 14
- Overview 5

P

- Packing Contents 7
- Pass Through (Cap) 22
- Pinouts
 - Analog Audio 53
- Pixel Format 24
- Playback Mode 14
- Playback Monitor Mode Screen 39
- Playback Source Selection 39
- Preference 18
- Preference File Location
 - Default Global 19
- Preset
 - Delete 48
 - Load 48
 - Save 48

- Preset Files Storage Location 18, 48
- Presets 18
- Presets Screen 47
- Progressive Pref 34
- Protocol 30

R

- Reference Video 10
 - Match Primary Format 10
- Reference Video Signal 10
- Ref In 23
- Reset 44
- Reset to Default 48
- Restart Services
 - Control Panel 17
- RGB Range 24, 28, 30, 31
- RP 188 47
- RS-422 10

S

- Save Preset 48
- SDI Color Sp 26
- SDI Config 26
- SDI I/O 10
- SDI Output Screen 27
- SDI RGB Rng 26
- Snapshot 47
- Software Installation 11
- Source
 - Video Input 26
- Source Gain 40
- Status LED 14
- System Requirements 7
- System Test 6, 12

T

- Test Pattern 22, 23
- Third Party Plugins 7, 12
- Thunderbolt 3 9
- Timecode Screen 46
- Timing
 - Horiz 23
 - Vert 23
- Transfer 33
- Transferring Saved Presets 48

U

- Uploading Custom User LUT file 45
- User Bits 47

V

- VANC Checkbox 35
- Variable Framerate (VFR) 47
- Video+Key 27
- Video Format 24
- Video In 23
- Video Input 26
- Video Path 15
- Video Setup Screen 34