

# HA5-4K Mini-Converter

## HDMI to SDI



## Installation and Operation Guide

Version 1.18r2  
Published April 23, 2025



# Notices

---

## Trademarks

---

AJA® and Because it matters.® are registered trademarks of AJA Video Systems, Inc. for use with most AJA products. AJA™ is a trademark of AJA Video Systems, Inc. for use with recorder, router, software and camera products. Because it matters.™ is a trademark of AJA Video Systems, Inc. for use with camera products.

Corvid Ultra®, Io®, Ki Pro®, KONA®, KUMO®, ROI® and T-Tap® are registered trademarks of AJA Video Systems, Inc.

AJA Control Room™, KiStor™, Science of the Beautiful™, TruScale™, V2Analog™ and V2Digital™ are trademarks of AJA Video Systems, Inc.

All other trademarks are the property of their respective owners.

## Copyright

---

Copyright © 2025 AJA Video Systems, Inc. All rights reserved. All information in this manual is subject to change without notice. No part of the document may be reproduced or transmitted in any form, or by any means, electronic or mechanical, including photocopying or recording, without the express written permission of AJA Video Systems, Inc.

## Contacting AJA Technical Support or Sales

---

Please have all pertinent information at hand prior to contacting AJA support or sales.

Support Telephone: +1.530.271.3190

Support Website: <https://www.aja.com/support/contact>

Support Email: [support@aja.com](mailto:support@aja.com)

Sales Email: [sales@aja.com](mailto:sales@aja.com)

Shipping Address: AJA Video Systems  
180 Litton Drive  
Grass Valley, CA 95945, USA

# Contents

---

Notices . . . . .	2
Trademarks . . . . .	2
Copyright . . . . .	2
Contacting AJA Technical Support or Sales . . . . .	2
Chapter 1 – Introduction . . . . .	4
Overview . . . . .	4
Default Operation . . . . .	4
AJA Mini-Config Control . . . . .	4
Features . . . . .	5
Block Diagram . . . . .	5
I/O Connections . . . . .	6
Lock LED Status Indicators . . . . .	6
Installation . . . . .	6
Chapter 2 – Operation . . . . .	7
USB Control and Setup—Using AJA Mini-Config . . . . .	7
Acquiring AJA Mini-Config . . . . .	7
Installing Mini-Config . . . . .	7
Running Mini-Config . . . . .	9
Operating AJA Mini-Config . . . . .	10
Tabbed Screens . . . . .	11
Input Tab Screen . . . . .	12
EDID Tab Screen . . . . .	13
Output Tab Screen . . . . .	14
HDR Metadata Tab Screen . . . . .	16
HDMI In HDR Metadata . . . . .	17
Output Overrides . . . . .	17
Audio Tab Screen . . . . .	18
Update Tab Screen . . . . .	19
Info Tab Screen . . . . .	20
Appendix A – Specifications . . . . .	22
HA5-4K Tech Specs . . . . .	22
Appendix B – Safety and Compliance . . . . .	25
5 Year Warranty and Liability Information . . . . .	32
AJA Software License Agreement . . . . .	33
Index . . . . .	36

# Chapter 1 – Introduction

---



## Overview

---

AJA's HA5-4K Mini-Converter provides high-quality conversion of HDMI to 4K SDI with 4x 3G SDI outputs. HA5-4K allows conversion of HDMI video from DSLRs, mirrorless cameras, action cameras, or prosumer 4K video cameras to 4K SDI for use in professional workflows. HA5-4K is also capable of analyzing HDR inframe data coming in over HDMI when used with AJA Mini-Config software.

## Default Operation

---

The HA5-4K auto configures to the connected HDMI input. The auto-configure function identifies the connected input and outputs the equivalent SDI format.

An SD or HD output signal uses only BNC SDI Out 1, and the remaining BNC output connectors are inactive by default. However, the DA function accessible with Mini-Config allows replication of the output signal on those extra output BNCs.

## AJA Mini-Config Control

---

AJA's Mini-Config application is available for firmware updates and advanced configuration. Configuration set via Mini-Config is stored in the HA5-4K unit through subsequent power cycles.

# Features

- Convert HDMI 2.0b to Quad-3G, 4K/UltraHD 60 fps at 4:4:4, 4:2:2, and 4:2:0
- Supports quadrant (square division) and 2SI (two sample interleave) 4K/ UltraHD SDI mapping
- EDID Emulation
- Analyzes HDR Infoframe data coming in over HDMI in accordance with HDMI v2.0b/CTA-861-G
- HDR Metadata VPID Pass-through with optional override
- Convert between integer and non-integer frame rates using frame drop/ repeat
- Embedded audio pass-through of E-AC-3 (Dolby Digital Plus) compressed audio, including DD+ Atmos (aka DD+ JOC) immersive sound
- Configure via USB port and supplied AJA Mini-Config software on PC/Mac
- Uses 5-20 VDC power (DWP-U-R1 universal power supply included)
- Five year warranty

*NOTE: 3D is not supported in this converter.*

*NOTE: 720p 4:4:4 formats are not supported in this release.*

# Block Diagram

*Figure 1. HA5-4K Converter, Simplified Block Diagram*

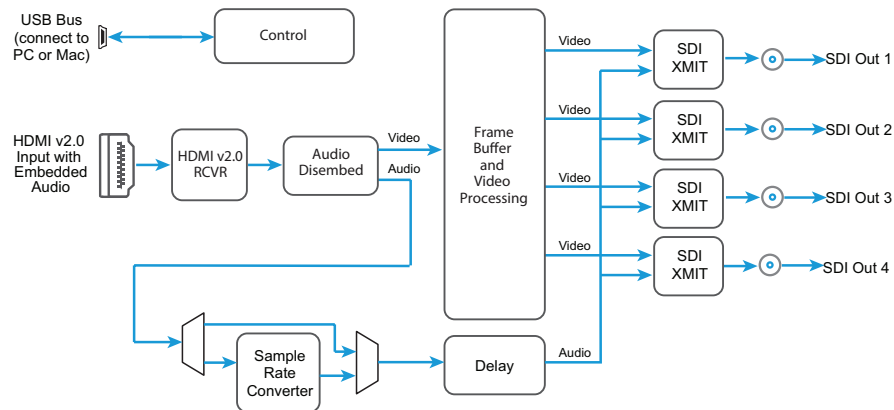

# I/O Connections

Figure 2. HA5-4K Converter Connections



## Lock LED Status Indicators

- Off = No signal / no valid input
- Green = SD-SDI
- Red = HD -SDI
- Amber = 3G-SDI

# Installation

Typically, HA5-4K installation consists of the following steps:

1. Ensure the HA5-4K is disconnected from power.
2. Connect video equipment to the converter BNCs and HDMI connector.
3. Apply power to the converter (AJA power supply included).
4. The HA5-4K will now run using the default factory settings. If you wish to alter the factory settings, you'll need to:
  - Install the AJA Mini-Config software on your computer
  - Attach the HA5-4K via USB
  - Make your changes using AJA Mini-Config setup screens.

This process is detailed in "[USB Control and Setup—Using AJA Mini-Config](#)" on page 7.

**NOTE:** The HA5-4K packs an unprecedented feature set into a mini converter box. As a result, the unit uses approximately 10 watts of power. It will be very warm to the touch, which is normal. The unit is engineered to operate across the full temperature range, from 0 to 40 degrees C.

**NOTE:** For highest reliability, the mini converter relies on convection cooling instead of using a built-in fan. Therefore, when installing the unit, mount in a location where it has access to air for proper cooling. Do not stack the HA5-4K with other mini converters.

# Chapter 2 – Operation

---

## USB Control and Setup—Using AJA Mini-Config

---

Your AJA Mini-Converter can be used right out of the box for some applications since it is designed to recognize inputs and perform standard actions automatically by default. However, to use its full capability, you must use AJA's Mini-Config software application for PCs and Macs. This same application can be used to update to new Mini-Converter software released by AJA.

### Acquiring AJA Mini-Config

---

AJA's Mini-Config application is available for download from the AJA website.

To download the latest AJA Mini-Config package, which includes the AJA Mini-Config application, Mini-Converter firmware, and documentation, go to:

<https://www.aja.com/en/products/mini-converters/mini-config-software>

Select either the Windows or Mac icon to download the desired version.

### Mini-Converter Documentation

---

Included with the AJA Mini-Config package is a complete set of documentation for all Mini-Converters supported by AJA Mini-Config. A .PDF of the *Installation and Operation Guide* for the currently connected Mini-Converter can be accessed from the AJA Mini-Config UI via the **Help/Manual** drop-down menu.

Documentation for all AJA Mini-Converters that use AJA Mini-Config can also be accessed directly in the AJA Mini-Config download package Documentation folder, and via the Documentation icon available on the Mac installer.

Documentation (and firmware) included with the AJA Mini-Config application are the versions available at the time of distribution. However, Mini-Converter software, firmware and documentation are updated regularly, so newer versions may exist.

To download the latest documentation for an individual Mini-Converter, go to:

<https://www.aja.com/en/category/mini-converters>

and navigate to the Support webpage of that Mini-Converter.

### Installing Mini-Config

---

#### PC Installation.

---

To install Mini-Config on a Windows PC:

1. Download the application from the AJA website (select the Windows icon on the Mini-Config Support web page).
2. Open the AJA\_MiniConfig.zip file
3. Double-click on the **MiniInstaller.msi** file.
4. A Setup Wizard will guide you through the installation.

Figure 3. Mini-Config PC Setup Wizard

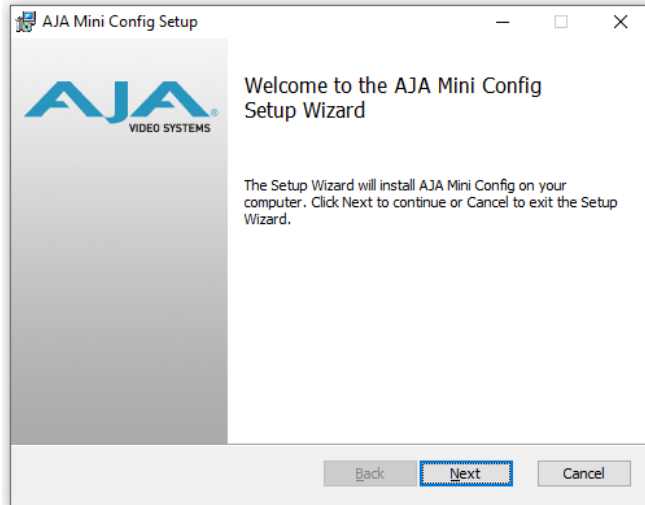

5. Click **Next** to begin. Answer the questions in the subsequent dialogues. When finished, an AJA Mini-Config shortcut will be installed on the desktop, and you will be able to locate the Mini-Config application in the AJA folder in the Programs listing.

*NOTE: If the same version of the Mini-Config application already exists on the PC, a different Setup Wizard appears.*

Figure 4. Mini-Config Setup Wizard, Reinstallation

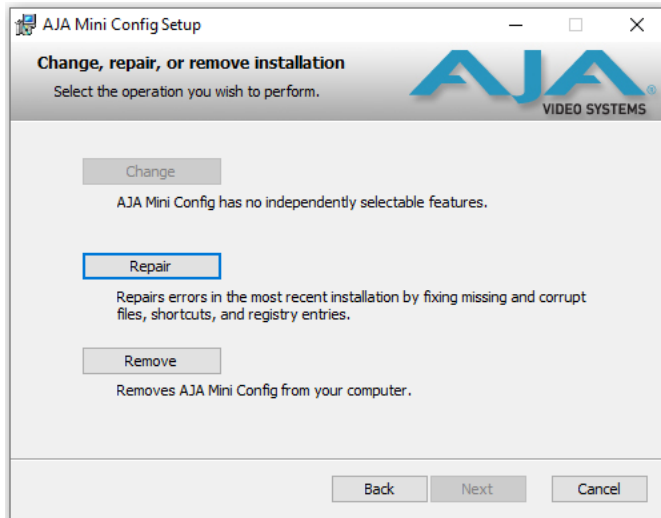

With this screen you can **Repair** (reinstall) or **Remove** (uninstall) Mini-Config on the PC.

## Mac Installation

To install the application on a Mac:

*NOTE: Intel and Apple Silicon based CPUs are supported for use with AJA Mini-Config software.*

1. Download the application from the AJA website (select the Apple icon on the Mini-Config Support web page).
2. Open the AJA\_MiniConfig folder.
3. Double-click on the **AJAMiniConfig.dmg** file.

4. Answer the prompt and a utility program will be launched.

Figure 5. Mini-Config Mac Installer

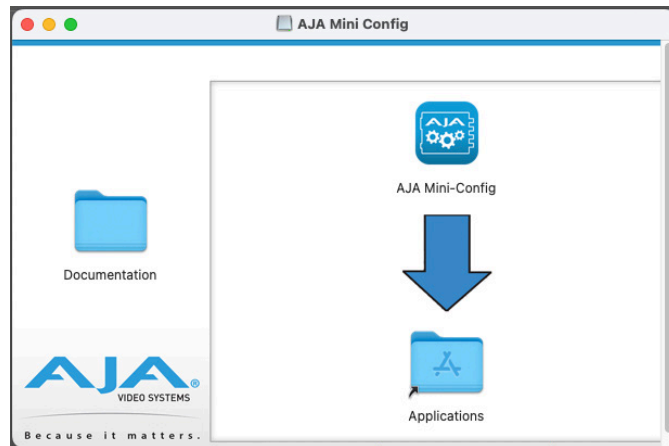

5. To complete the installation drag the **MiniConfig.app** icon to the Applications folder.

## Running Mini-Config

Connect the Mini-Converter to the PC or Mac via the supplied USB cable. Connect the external power supply (supplied) to the Mini-Converter.

### PC Startup

To run Mini-Config on a PC, double-click on the AJA Mini-Config icon on your desktop, or open the AJA folder in the program list and click on the AJA Mini-Config application located inside the Mini-Config folder.

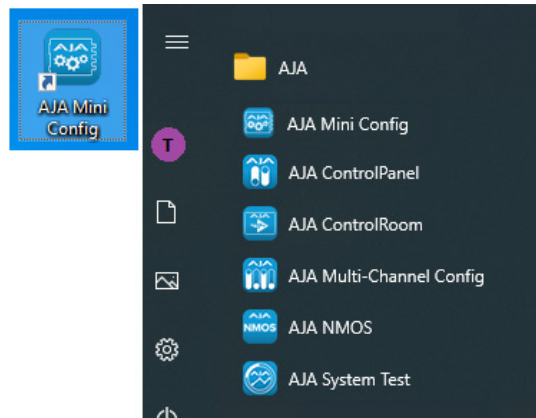

### Mac Startup

To run Mini-Config on a Mac, open the Applications folder and locate the AJA Mini-Config application. Double-click the application to launch it.

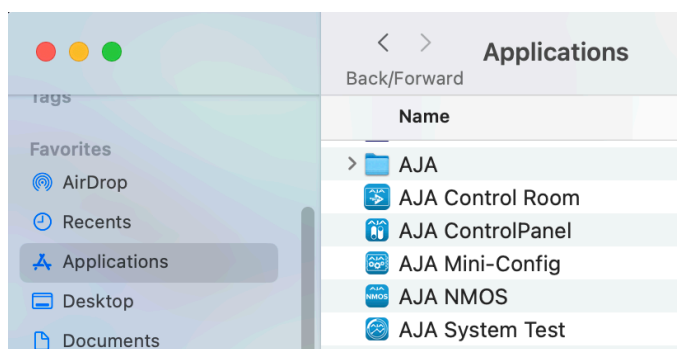

## Saving Setups

A **File** drop down menu on the Mini-Config application bar (similar for Mac and PC) allows you to save the current state of the Mini-Converter to a preset file for later recall.

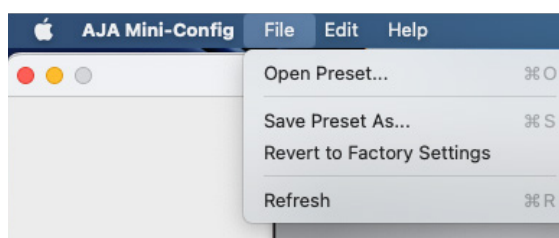

Using this feature you can set up the converter for different applications, storing each configuration (**Save Preset As...**) with a unique name for easy recall (**Open Preset...**).

A **Revert to Factory Settings** menu item similarly allows you to change the settings back to AJA's factory defaults.

## Operating AJA Mini-Config

The AJA Mini-Config application provides a graphic interface for viewing settings and updating software. It consists of an information area at the top that shows the available Mini-Converters attached to the computer via USB, with a graphical rendering of the selected Mini-Converter showing all the connectors and their current state.

Colored text next to the connectors indicates the signal type and what the Mini-Converter is doing:

- Blue text indicates the values automatically selected
- Black text indicates values that you have manually selected
- Red text indicates the Mini-Converter is not detecting a signal, or cannot operate with the current user settings.

*NOTE: Even if no output device is detected, the SDI connector text still shows the signal it is outputting.*

*NOTE: Configuration settings in red will change based on the attached output device as well as input signals. For improved accuracy and reliability, you should configure the Mini-Converter only when the target output device is attached and input signals are supplied at the inputs.*

Screens are virtually the same on both PC and Mac, with subtle differences that reflect the general look of the platform environment.

Figure 6. Example AJA Mini-Config Screen

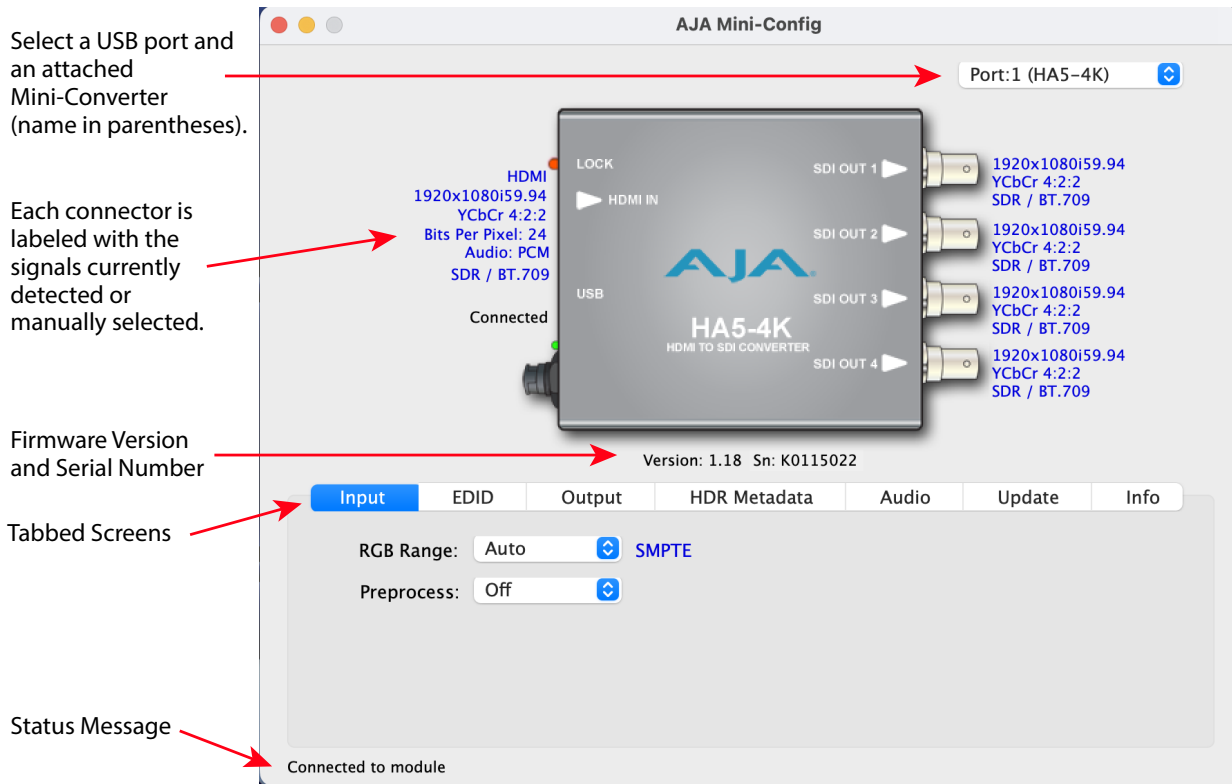

Select a USB port and an attached Mini-Converter (name in parentheses).

Each connector is labeled with the signals currently detected or manually selected.

Firmware Version and Serial Number

Tabbed Screens

Status Message

Selecting a Mini-Converter with the pulldown menu causes this application to connect to the selected converter. The graphic of the Mini-Converter and text below it provides:

- Type of converter
- Firmware version
- Serial number of the unit.

A status field at the bottom of the screen shows if your application is connected and communicating with the Mini-Converter.

When configuring the Mini-Converter, select it from the top pulldown, view the current settings and change any values. Making a change communicates that new value to the Mini-Converter's non-volatile memory.

## Tabbed Screens

The Tabs delineate control screens with groups of controls for each type of task to be performed. The controls for the actual configuration parameters are specific to each Mini-Converter type. When you Click on any of the tab buttons, the pane below the tabs will change to match your tab selection. Any changes you make are immediately applied and will be saved, overwriting previous settings.

# Input Tab Screen

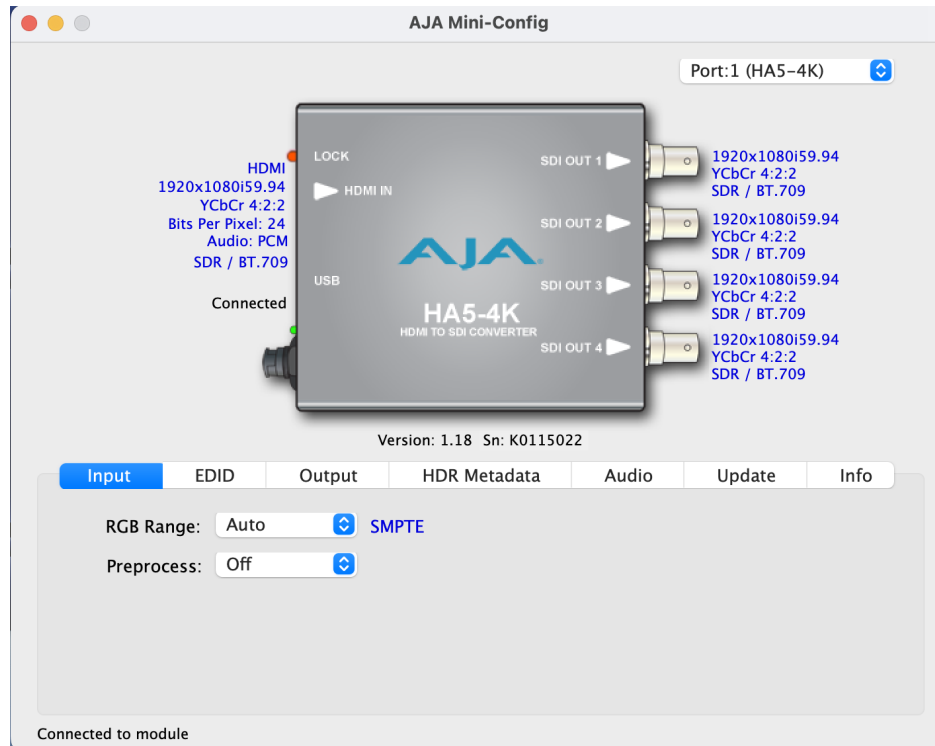

## About Bits Per Pixel

With HDMI, YCbCr is always reported as 24bpp, which is 12 bit depth (whether the input signal is 8, 10, or 12 bit depth).

To determine the bit depth for RGB, divide the bpp by 3. For example:

- 24bpp = 8 bit depth
- 30bpp = 10 bit depth
- 36bpp = 12 bit depth

## RGB Range

Selects the Input Video Color Range for RGB signals. Choose from:

- Auto (default)
- SMPTE
- Full

## Preprocess

Preprocessing circuitry allows HA5-4K to receive high jitter sources.

- Off (default) - No jitter preprocessing.
- On - Jitter preprocessing active.

# EDID Tab Screen

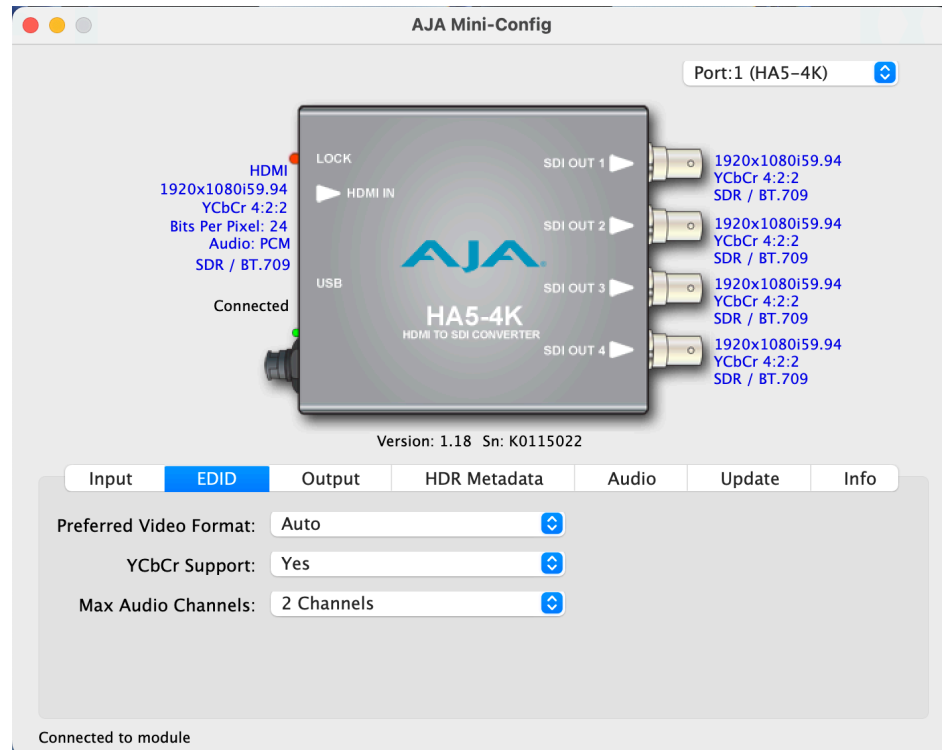

EDID (Extended Display Identification Data) is used to find the highest signal resolution that is compatible with both the source and the destination. When an HDMI source device is initially connected to the HA5-4K, the HA5-4K will communicate with the signal source about what formats the HA5-4K supports. The HA5-4K and the signal source will negotiate the best mutually compatible signal resolution.

## Preferred Video Format

The HA5-4K's default EDID selection is Auto, but it can be configured by the user to any of the following formats and frame rates:

- Auto
- 1280x720p50
- 1280x720p60
- 1920x1080i50
- 1920x1080i60
- 1920x1080p50
- 1920x1080p60
- 2048x1080p50
- 2048x1080p60
- 3840x2160p50
- 3840x2160p60

## YCbCr Support

This parameter determines whether the HA5-4K will signal to its HDMI source that the HA5-4K will support (Yes) or will not support (No) YCbCr input formats.

*NOTE: RGB formats are always supported by default in an HDMI sink.*

## Max Audio Channels

Selects the number of audio channels to be used from the signal source. Choose from:

- 2 Ch
- 8 Ch

## Output Tab Screen

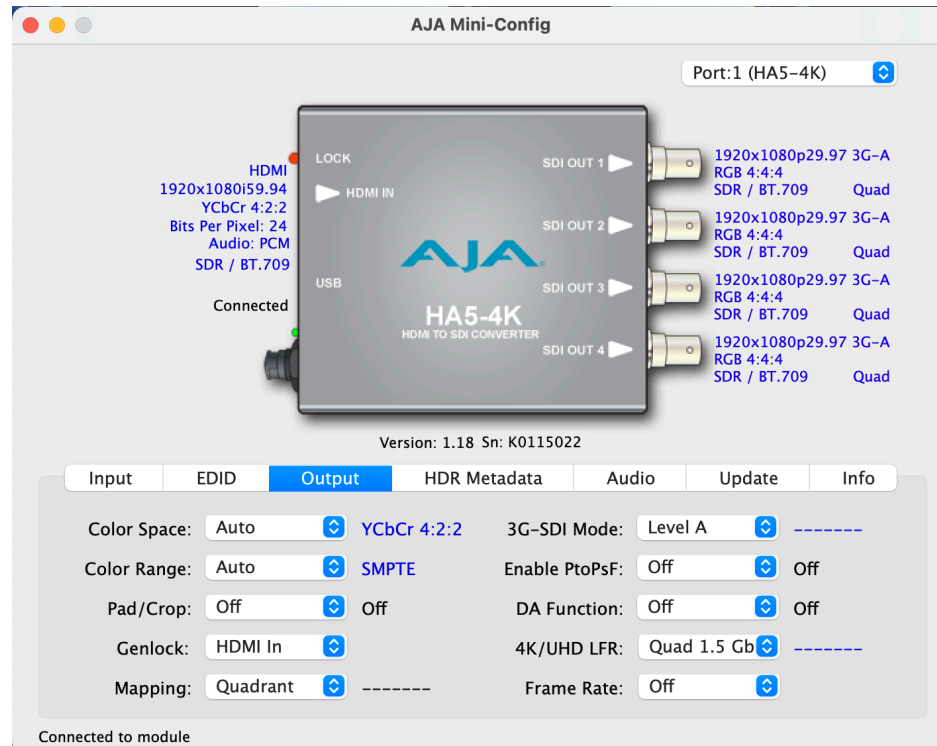

## Color Space

Selects the desired output video format. Choose from the following:

- Auto (default) Selects the video format based on the input video and the attached device's capabilities.
- 4:2:2 YCbCr
- 4:4:4 RGB
- 4:4:4 YCbCr (HFR 4K/UltraHD 4:4:4 limited to 8 bit)

## Color Range

Selects the Color Range. Choose from the following:

- Auto - (default) Selects SMPTE vs Full based on incoming HDMI and setting of Input Color Range.
- SMPTE
- Full

## Pad/Crop

---

Selects pixel padding and cropping conversions between UltraHD and 4K formats. Choose from the following:

- Off - (default) No processing
- Pad - Add black pixels to the left and right sides of the raster to fill a wider aspect ratio (UltraHD to 4K, or HD to 2K).
- Crop - Crop pixels from left and right sides of the raster to fit a narrower aspect ratio (4K to UltraHD, or 2K to HD).

## Genlock

---

Select the genlock reference. Choose from the following:

- HDMI In (default) - Locks to incoming HDMI clock.
- FreeRun - Locks to free running SDI internal clock.

## Mapping

---

Select the 4K/UltraHD pixel mapping format:

- Quadrant (default) - Square Division
- 2SI - Two Sample Interleave

## 3G-SDI Mode

---

Selects the 3G SDI Video Mode. Choose from the following:

- Level A (default)
- Level B-DL (Dual Link)
- 2x1.5G-SDI

## Enable PtoPsF

---

Choose to convert incoming progressive format HDMI video to PsF SDI video.

- Off - (default) No conversion.
- On - Converts the video to PsF (if it is progressive format and low frame rate).

## DA Function

---

Choose to replicate the signal on any extra BNC outputs. An SD or HD input signal can be distributed to all four BNCs. A 4K/UltraHD LFR dual stream output signal can be distributed to each pair (1-2 and 3-4) of BNC output connectors.

- Off - (default) no video sent to any extra BNC outputs;
- On - For HD/SD signals, three additional copies of the signal are sent to the SDI Out 2, 3, and 4 BNCs. For dual link output signals one additional copy of the signal is sent to the pair of SDI Out 3 and 4 BNCs.

## 4K/UHD LFR

---

Controls how Low Frame Rate (23.98, 24, 25, 29.97, 30 fps) incoming video will be output, using all four BNC outputs (at 1.5 Gbps each), or two BNC outputs (at 3 Gbps each). Choose from the following:

- Quad 1.5 Gbps (default)
- Dual 3 Gbps

## Frame Rate

The Output Frame Rate control can be set to convert an integer input frame rate (like p60) to the matching fractional or non-integer output frame rate (like p59.94). The frame rate converter accomplishes this by dropping a complete video frame every 1001 frames. This control can also be set to convert a fractional or non-integer input frame rate (like p59.94) to an integer output frame rate (like p60), accomplished by repeating a complete video frame every 1000 frames.

**NOTE:** Because audio is disembedded prior to any video processing and then re-embedded after video processing, there will be no disruption to audio when the frame rate converter is working.

- Off (default) - No frame rate conversion will be performed. The output frame rate will match the input frame rate.
- Fractional - If the input frame rate is an integer frame rate, the output frame rate will be converted to the matching fractional frame rate. Fractional frame rate input signals are unaffected.
- Integer - If the input frame rate is a fractional frame rate, the output frame rate will be converted to the matching integer frame rate. Integer frame rate input signals are unaffected.

## HDR Metadata Tab Screen

The screenshot shows the AJA Mini-Config software interface. At the top, it says "AJA Mini-Config" and "Port:1 (HA5-4K)". The central part of the interface shows a 3D rendering of the AJA HA5-4K HDMI to SDI Converter. On the left, the HDMI input is configured with "3840x2160p29.97", "RGB 4:4:4", "Bits Per Pixel: 36", and "Audio: PCM PQ / BT.2020". On the right, there are four SDI output ports, each configured with "1920x1080p29.97 3G-A", "RGB 4:4:4", and "PQ / BT.2020 Quad". Below the hardware rendering, it says "Version: 1.18 Sn: K0115022". At the bottom, there are several tabs: "Input", "EDID", "Output", "HDR Metadata" (which is selected), "Audio", "Update", and "Info". The "HDR Metadata" tab is active, showing "HDMI In HDR Metadata" with "HDR Infoframe Detected: YES". It lists several parameters: Red: x[2] 0.70800 y[2] 0.29200; Green: x[0] 0.17000 y[0] 0.79700; Blue: x[1] 0.13100 y[1] 0.04600; White Pt: x 0.31270 y 0.32900; DM Lum.: min 0.0005 max 1000; Max: CLL 1000 FALL 400. To the right of these parameters are "Output Overrides" with "SDR/HDR: Auto PQ" and "Colorimetry: Auto BT.2020". At the bottom left of the tab, it says "Connected to module".

Click on the HDR Metadata tab to view the received High Dynamic Range static metadata extensions settings.

The HDR Metadata tab indicates whether HDR metadata is being received on the HDMI input. If so, it decodes and presents the static metadata descriptors as defined in CTA-861.3 and HDMI v2.0a.

**NOTE:** The HA5-4K HDR function does not modify the video data.

**NOTE:** Hover the cursor over each parameter field to view its corresponding CTA-861.3 description in a pop-up window.

## HDMI In HDR Metadata

---

The twelve Custom Metadata parameters on the left side of the HDR Metadata displays the incoming HDR color, white point, and luminance values, if present.

### HDR Infoframe Detected

---

Indicates whether an HDR Infoframe is being received.

- YES - HDR metadata is being received.
- NO - HDR metadata is not being received.

### Red, Green, Blue, White Point

---

These eight values define the color gamut and white point, and are adjustable in units of 0.00002 cd/m<sup>2</sup>, with a range of 0.00000 to 1.00000 cd/m<sup>2</sup>.

### DM Lum

---

These two parameters define the Display Mastering Luminance.

- Minimum: Defines the floor of the SMPTE ST 2086 color volume (in the case of HDR) and is determined by the mastering environment.
  - Range: 0.00000 cd/m<sup>2</sup> to 1.00000 cd/m<sup>2</sup>.
  - Step size: 0.00002 cd/m<sup>2</sup>.
- Maximum: Defines the ceiling of the SMPTE ST 2086 color volume (in the case of HDR) and is determined by the mastering environment.
  - Range: 1 cd/m<sup>2</sup> to 65535 cd/m<sup>2</sup>.
  - Step size: 1 cd/m<sup>2</sup>.

### Maximum: CLL

---

Represents the highest-value pixel component in an entire scene. It is determined by analyzing each frame of video, and can be determined in the post environment.

- Range: 1 cd/m<sup>2</sup> to 65535 cd/m<sup>2</sup>.
- Step size: 1 cd/m<sup>2</sup>.

### Maximum: FALL

---

Represents the maximum of frame-based average light levels taken over an entire scene, and can be determined in the post environment.

- Range: 1 cd/m<sup>2</sup> to 65535 cd/m<sup>2</sup>.
- Step size: 1 cd/m<sup>2</sup>.

## Output Overrides

---

The override controls on the right can be used to replace incoming or missing HDR metadata with alternative values for the HA5-4K's SDI VPID outputs.

## SDR/HDR

This setting controls what SDR/HDR metadata value is applied to the video output.

- Auto - Passes the SDR/HDR value from the video input to the output.
- SDR - An SDR value is applied to the output.
- PQ - A PQ value is applied to the output.
- HLG - An HLG value is applied to the output.

## Colorimetry

This setting controls what Colorimetry metadata value is applied to the video output.

- Auto - Passes the Colorimetry value from the video input to the output.
  - BT.601, BT.709 and BT.2020 values are passed through.
    - If a non-supported colorimetry value is received, then BT.601 is signaled for SD formats and BT.709 is signaled for HD/UltraHD formats.
- BT.709 - A BT.709 value is applied to the output.
- BT.2020 - A BT.2020 value is applied to the output.

## Audio Tab Screen

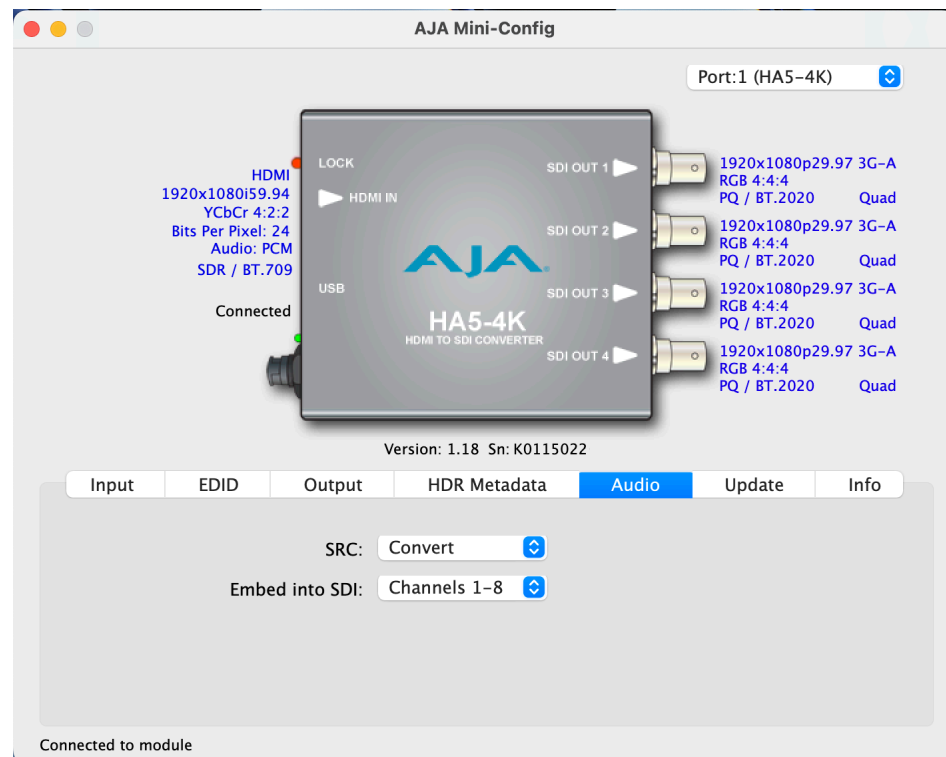

## SRC

Choose the SRC (Sample Rate Converter) audio conversion to be performed on the incoming HDMI audio.

- Convert - HDMI audio will be sample rate converted, if necessary, to 24-bit/48 kHz audio.

- Pass Through - HDMI audio will be passed to the SDI embedded audio channels without conversion.

## Embed into SDI

Choose which set of SDI embedded audio output channels will receive up to eight channels of embedded audio received from the incoming HDMI signal. Audio is embedded only into the SDI 1 output link, which may be carried on one or more of the SDI Out BNC connectors, depending on configuration. Choose from the following:

- Channels 1-8
- Channels 9-16

In Quad output mode, the SDI embedded audio will only be sent out the SDI Out 1 BNC.

In Dual output mode, when the DA function is Off the audio will only be sent out the SDI Out 1 BNC. When the DA Function is On, the audio will also be sent out the SDI Out 3 BNC.

In Single output mode, when the DA function is Off the audio will only be sent out the SDI Out 1 BNC. When the DA Function is On, the audio will also be sent out the SDI Out 2, 3, and 4 BNCs.

## Update Tab Screen

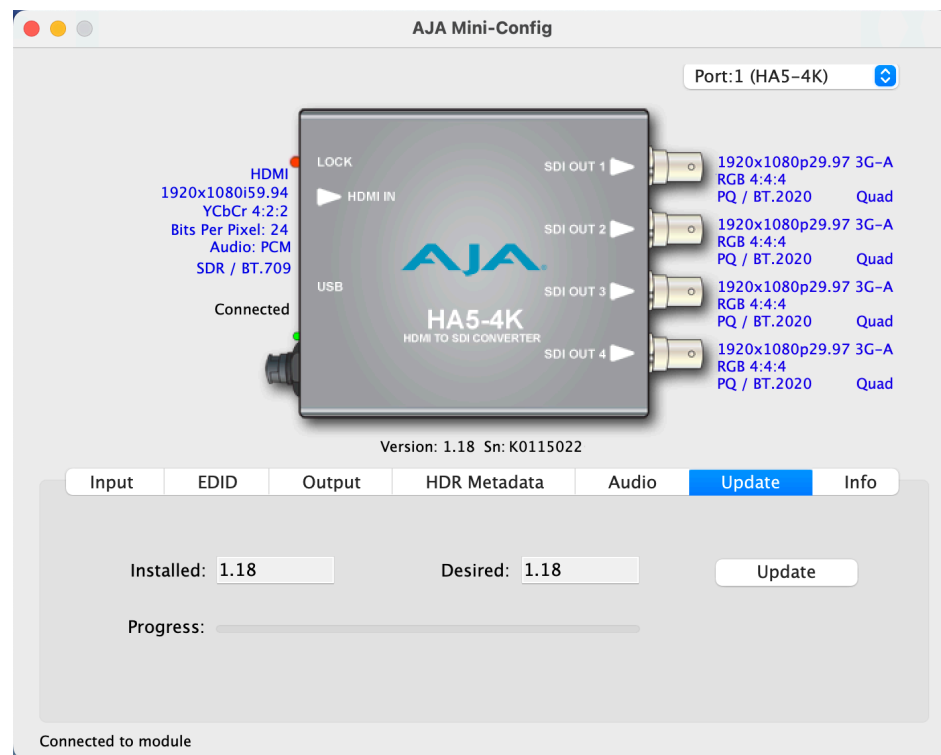

Use this Update screen to view the software version currently installed on the converter or install new firmware.

**NOTE:** When discussing Mini-Converters, "Firmware" is software that will be stored in the Mini-Converter's non-volatile memory and used when it is powered up. This is something different than the AJA Mini-Config application software. The version numbers shown in the Update screen refer only to the firmware.

## Installed

This field shows the version of the firmware currently installed inside the Mini-Converter.

## Desired

This field shows the version of firmware embedded in the AJA Mini-Config application which you can install into the Mini-Converter by clicking the Update button.

## Update

This button initiates a software update operation loading the "Desired" version of firmware into the Mini-Converter's non-volatile memory.

## Progress

This indicator bar shows the progress of firmware installation.

See "[Acquiring AJA Mini-Config](#)" on page 7 and "[Installing Mini-Config](#)" on page 7 for more information.

## Info Tab Screen

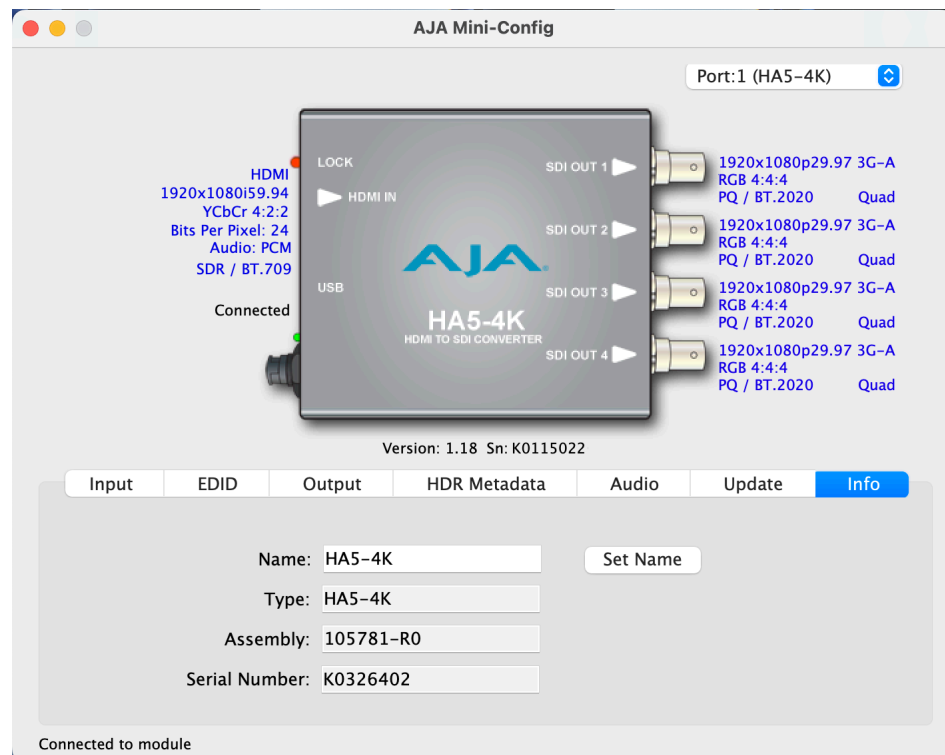

This screen provides basic information about the Mini-Converter. This information is useful when calling AJA Support for service or technical support.

## Name

---

This field allows you to give your Mini-Converter a name. This can be useful if you have several Mini-Converters attached to a Mac/PC via USB so you can distinguish between them easily (especially if they're the same model). Click Set Name to apply new name.

## Type

---

This is the factory set model name of the Mini-Converter.

## Assembly

---

This is the factory assembly number.

*NOTE: Some newly manufactured Mini-Converters may not be backwards compatible with older firmware and Mini-Config versions. It is highly recommended that you update the firmware to avoid any potential issues. Please check the current Release Notes to confirm that the Assembly number is compatible with any older firmware or Mini-Config versions.*

## Serial Number

---

This is the factory set unique serial number of your Mini-Converter. If you ever call AJA Support for service, you may be asked for this number.

# Appendix A – Specifications

---

## HA5-4K Tech Specs

---

### Video Formats

---

- (4K) 4096 x 2160p
- (UltraHD) 3840 x 2160p
- (2K) 2048 x 1080p
- (HD) 1920 x 1080p
- (HD) 1920 x 1080i
- (HD) 1280 x 720p
- (SD) 720 x 576p
- (SD) 720 x 576i
- (SD) 720 x 480p
- (SD) 720 x 480i

*NOTE: Raster and Frame Rate Dependent, please see HA5-4K Video Formats in the Download / Documents section of the website product page.*

### Video Input Digital

---

- 1x HDMI Type A connector, HDMI v2.0b
- HDR Infoframe decoder as defined in CTA-861.3 and HDMI v2.0b
- HDR VPID generation with pass-through or override for Colorimetry and Transfer Characteristic
- YCbCr 4:2:2/4:4:4/4:2:0
- RGB 4:4:4, SMPTE or Full level
- 24, 30, or 36 Bits Per Pixel (HFR 4K/UltraHD 4:4:4 limited to 24 BPP)
- (4K) 4096x2160p 23.98, 24, 25, 29.97, 30, 47.95, 48, 50, 59.94, 60
- (UltraHD) 3840x2160p 23.98, 24, 25, 29.97, 30, 50, 59.94, 60
- (2K) 2048x1080p 23.98, 24, 25, 29.97, 30, 47.95, 48, 50, 59.94, 60
- (HD) 1920x1080p 23.98, 24, 25, 29.97, 30, 50, 59.94, 60
- (HD) 1920x1080i 50, 59.94, 60
- (HD) 1280x720p 50, 59.94, 60
- (SD) 720x576p 50
- (SD) 720x576i 50
- (SD) 720x480p 59.94
- (SD) 720x480i 59.94

### HDCP Decryption

---

- Not supported. By definition, SDI outputs are unencrypted.

### Video Output Digital

---

- 4x 3G-SDI BNC, SMPTE-259/292/424
- YCbCr 4:2:2/4:4:4
- RGB 4:4:4, SMPTE or Full level
- 10-bit
- Two Sample Interleave (2SI) or Square Division (Quadrant) pixel mapping

- 4x 3 Gb SDI (Level A or B Dual Link)
  - (4K) 4096x2160p 23.98, 24, 25, 29.97, 30, 47.95, 48, 50, 59.94, 60
  - (UltraHD) 3840x2160p 23.98, 24, 25, 29.97, 30, 50, 59.94, 60
- 4x 1.5 Gb SDI
  - (4K) 4096x2160p 23.98, 24, 25, 29.97, 30
  - (UltraHD) 3840x2160p 23.98, 24, 25, 29.97, 30
- 2x 3 Gb SDI (Level B Dual Stream)
  - (4K) 4096x2160p 23.98, 24, 25, 29.97, 30
  - (UltraHD) 3840x2160p 23.98, 24, 25, 29.97, 30
- 2x 1.5 Gb SDI (Dual Link HD-SDI), SMPTE-372
  - (HD) 1920x1080p 50, 59.94, 60
- 1x 3 Gb SDI (Level A or B Dual Link)
  - (2K) 2048x1080p 23.98, 24, 25, 29.97, 30, 47.95, 48, 50, 59.94, 60
  - (2K) 2048x1080PsF 23.98, 24, 25, 29.97, 30
  - (HD) 1920x1080p 23.98, 24, 25, 29.97, 30, 50, 59.94, 60
  - (HD) 1920x1080PsF 23.98, 24, 25, 29.97, 30
  - (HD) 1920x1080i 50, 59.94, 60
  - (HD) 1280x720p\*\* 50, 59.94, 60
- 1x 1.5 Gb SDI
  - (2K) 2048x1080p 23.98, 24, 25, 29.97, 30
  - (2K) 2048x1080PsF 23.98, 24, 25, 29.97, 30
  - (HD) 1920x1080p 23.98, 24, 25, 29.97, 30
  - (HD) 1920x1080PsF 23.98, 24, 25, 29.97, 30
  - (HD) 1920x1080i 50, 59.94, 60
  - (HD) 1280x720p 50, 59.94, 60
- 1x 270 Mb SDI
  - (SD) 625i 50
  - (SD) 525i 59.94

\*PsF is Level B Dual Link

\*\*1280x720p is Level A Only

#### Audio Pass-Through Formats

---

- PCM
- Dolby Digital (AC-3)
- Dolby Digital Plus (E-AC-3), including Atmos Immersive Sound (JOC)

#### Audio Input Digital

---

- HDMI embedded audio, 24-bit, 8-channel

#### Audio Output Digital

---

- SDI embedded audio, 24-bit (SD limited to 20-bit), 16-channel

#### User Interface

---

- USB port used with supplied cable and Mini-Config software application to configure the device via Mac or Windows.

#### Size (w x d x h)

---

- 5.76" x 4.02" x 0.90" (146.31 × 102.11 × 22.86 mm)

#### Weight

---

- 0.6 lb (0.3 kg)

## Power

---

- 5-20VDC regulated, 10 watts, power supply required, included with purchase
- AC Adapter: 100-240VAC, 50/60 Hz, universal input

## Environment

---

- Safe Operating Temperature: 0 to 40 C (32 to 104 F)\*
- Safe Storage Temperature (Power OFF): -40 to 60 C (-40 to 140 F)
- Operating Relative Humidity: 10-90% noncondensing
- Operating Altitude: <3,000 meters (<10,000 feet)

\*HA5-4K uses approximately 10 watts of power and convection cooling. It will be warm to the touch, which is normal. When installing the unit, mount in a location where it has access to air for proper cooling. Do not stack the HA5-4K with other Mini-Converters.

# Appendix B – Safety and Compliance

---

## Federal Communications Commission (FCC) Compliance Notices

---

### Class A Interference Statement

---

This equipment has been tested and found to comply with the limits for a Class A digital device, pursuant to Part 15, Subpart B of the FCC Rules. These limits are designed to provide reasonable protection against harmful interference in a residential installation. This equipment generates, uses, and can radiate radio frequency energy and, if not installed and used in accordance with the instructions, may cause harmful interference to radio communications. However, there is no guarantee that interference will not occur in a particular installation. If this equipment does cause harmful interference to radio or television reception, which can be determined by turning the equipment off and on, the user is encouraged to try to correct the interference by one or more of the following measures:

- Reorient or relocate the receiving antenna.
- Increase the separation between the equipment and receiver.
- Connect the equipment into an outlet on a circuit different from that to which the receiver is connected.
- Consult the dealer or an experienced radio/TV technician for help.

### FCC Caution

---

This device complies with Part 15 of the FCC Rules. Operation is subject to the following two conditions: (1) This device may not cause harmful interference, and (2) this device must accept any interference received, including interference that may cause undesired operation.

## Canadian ICES Statement

---

### Canadian Department of Communications Radio Interference Regulations

This digital apparatus does not exceed the Class A limits for radio-noise emissions from a digital apparatus as set out in the Radio Interference Regulations of the Canadian Department of Communications. This Class A digital apparatus complies with Canadian ICES-003.

### Règlement sur le brouillage radioélectrique du ministère des Communications

Cet appareil numérique respecte les limites de bruits radioélectriques visant les appareils numériques de classe A prescrites dans le Règlement sur le brouillage radioélectrique du ministère des Communications du Canada. Cet appareil numérique de la Classe A est conforme à la norme NMB-003 du Canada.

## European Union, European Free Trade Association (EFTA) and United Kingdom Regulatory Compliance

---

This equipment may be operated in the countries that comprise the member countries of the European Union, European Free Trade Association and the United Kingdom. These countries, listed in the following paragraph, are referred to as The European Community throughout this document:

AUSTRIA, BELGIUM, BULGARIA, CROATIA, CZECH REPUBLIC, DENMARK, ESTONIA, FINLAND, FRANCE, GERMANY, GREECE, HUNGARY, ICELAND, IRELAND, ITALY, LATVIA, LIECHTENSTEIN, LITHUANIA, LUXEMBOURG, MALTA, NETHERLANDS, NORWAY, POLAND, PORTUGAL, REPUBLIC OF CYPRUS, ROMANIA, SLOVAK REPUBLIC, SLOVENIA, SPAIN, SWEDEN, SWITZERLAND, UNITED KINGDOM

## Declaration of Conformity

Marking by these symbols indicates compliance with the Essential Requirements of the EMC Directive of the European Union 2014/30/EU.



This equipment meets the following conformance standards:

### Safety

EN 62368-1: 2014 + A11 (T-Mark License)

IEC 62368-1: 2014 (CB Scheme Certificate)

### Emissions

EN 55032: 2015 + A11: 2020, CISPR 32: 2015

EN 61000-3-2: 2014, EN 61000-3-3: 2013

### Immunity

EN 55035: 2017 + A11: 2020, EN 61000-4-2: 2009, EN 61000-4-3: 2006+ A1: 2008 + A2: 2010, EN 61000-4-4: 2012, EN 61000-4-5: 2014/A1: 2017, EN 61000-4-6: 2014, EN 61000-4-8: 2010, EN 61000-4-11: 2020

Environments: E2, E3 and E4

The product is also licensed for additional country specific standards as required for the International Marketplace.



**Warning!** This is a Class A product. In a domestic environment, this product may cause radio interference, in which case, the user may be required to take appropriate measures.

**Achtung!** Dieses ist ein Gerät der Funkstörgrenzwertklasse A. In Wohnbereichen können bei Betrieb dieses Gerätes Rundfunkstörungen auftreten, in welchen Fällen der Benutzer für entsprechende Gegenmaßnahmen verantwortlich ist.

**Attention!** Ceci est un produit de Classe A. Dans un environnement domestique, ce produit risque de créer des interférences radioélectriques, il appartiendra alors à l'utilisateur de prendre les mesures spécifiques appropriées..

## Recycling Notice



This symbol on the product or its packaging indicates that this product must not be disposed of with your other household waste. Instead, it is your responsibility to dispose of your waste equipment by handing it over to a designated collection point for the recycling of waste electrical and electronic equipment. The separate collection and recycling of your waste equipment at the time of disposal will help conserve natural resources and ensure that it is recycled in a manner that protects human health and the environment. For more information about where you can drop off your waste for recycling, please contact your local authority, or where you purchased your product.

## Korea KCC Compliance Statement

---

사 용 자 안 내 문

이 기기는 업무용 환경에서 사용할 목적으로 적합성평가를 받은 기기로서 가정용 환경에서 사용하는 경우 전파간섭의 우려가 있습니다.

## Taiwan Compliance Statement

---

**警告使用者：**  
這是甲類的資訊產品，在居住的環境中使用時，可能會造成射頻干擾，在這種情況下，使用者會被要求採取某些適當的對策。

This is a Class A product based on the standard of the Bureau of Standards, Metrology and Inspection (BSMI) CNS 13438, Class A. In a domestic environment this product may cause radio interference in which case the user may be required to take adequate measures.

## Japanese Compliance Statement

---

この装置は、クラスA情報技術装置です。この装置を家庭環境で使用すると電波妨害を引き起こすことがあります。この場合には使用者が適切な対策を講ずるよう要求されることがあります。 VCCI-A

This is a Class A product based on the standard of the VCCI Council (VCCI-32: 2016). If this equipment is used in a domestic environment, radio interference may occur, in which case, the user may be required to take corrective actions.

## Translated Warning and Caution Messages

---

The following caution statements, warning conventions, and warning messages apply to this product and manual.



Warning Symbol



Caution Symbol

## Before Operation Please Read These Instructions



**Warning!** Read and follow all warning notices and instructions marked on the product or included in the documentation.

**Avertissement!** Lisez et conformez-vous à tous les avis et instructions d'avertissement indiqués sur le produit ou dans la documentation.

**Warnung!** Lesen und befolgen Sie die Warnhinweise und Anweisungen, die auf dem Produkt angebracht oder in der Dokumentation enthalten sind.

**¡Advertencia!** Lea y siga todas las instrucciones y advertencias marcadas en el producto o incluidas en la documentación.

**Aviso!** Leia e siga todos os avisos e instruções assinalados no produto ou incluídos na documentação.

**Avviso!** Leggere e seguire tutti gli avvisi e le istruzioni presenti sul prodotto o inclusi nella documentazione.



**Warning!** Do not use this device near water and clean only with a dry cloth.

**Avertissement!** N'utilisez pas cet appareil près de l'eau et nettoyez-le seulement avec un tissu sec.

**Warnung!** Das Gerät nicht in der Nähe von Wasser verwenden und nur mit einem trockenen Tuch säubern.

**¡Advertencia!** No utilice este dispositivo cerca del agua y límpielo solamente con un paño seco.

**Aviso!** Não utilize este dispositivo perto da água e limpe-o somente com um pano seco.

**Avviso!** Non utilizzare questo dispositivo vicino all'acqua e pulirlo soltanto con un panno asciutto.



**Warning!** Do not block any ventilation openings. Install in accordance with the manufacturer's instructions.

**Avertissement!** Ne bloquez aucune ouverture de ventilation. Suivez les instructions du fabricant lors de l'installation.

**Warnung!** Die Lüftungsöffnungen dürfen nicht blockiert werden. Nur gemäß den Anweisungen des Herstellers installieren.

**¡Advertencia!** No bloquee ninguna de las aberturas de la ventilación. Instale de acuerdo con las instrucciones del fabricante.

**Aviso!** Não obstrua nenhuma das aberturas de ventilação. Instale de acordo com as instruções do fabricante.

**Avviso!** Non ostruire le aperture di ventilazione. Installare in conformità con le istruzioni del fornitore.



**Warning!** Do not install near any heat sources such as radiators, heat registers, stoves, or other apparatus (including amplifiers) that produce heat.

**Avertissement!** N'installez pas l'appareil près d'une source de chaleur telle que des radiateurs, des bouches d'air de chauffage, des fourneaux ou d'autres appareils (amplificateurs compris) qui produisent de la chaleur.

**Warnung!** Nicht in der Nähe von Wärmequellen wie Heizkörpern, Heizregistern, Öfen oder anderen Wärme erzeugenden Geräten (einschließlich Verstärkern) aufstellen.

**¡Advertencia!** No instale cerca de fuentes de calor tales como radiadores, registros de calor, estufas u otros aparatos (incluidos amplificadores) que generan calor.

**Aviso!** Não instale perto de nenhuma fonte de calor tal como radiadores, saídas de calor, fogões ou outros aparelhos (incluindo amplificadores) que produzam calor.

**Avviso!** Non installare vicino a fonti di calore come termosifoni, diffusori di aria calda, stufe o altri apparecchi (amplificatori compresi) che emettono calore.



**Warning!** Do not defeat the safety purpose of the polarized or grounding-type plug. A polarized plug has two blades with one wider than the other. A grounding type plug has two blades and a third grounding prong. The wide blade or the third prong are provided for your safety. If the provided plug does not fit into your outlet, consult an electrician for replacement of the obsolete outlet.

**Avertissement!** La sécurité de la prise polarisée ou de la prise de type mise à la terre ne doit en aucun cas être empêchée de fonctionner. Une prise polarisée a deux broches, l'une étant plus large que l'autre. Une prise de type mise à la terre a deux broches et une troisième broche pour la mise à la terre. La broche large ou la troisième broche sont fournies pour votre sécurité. Si la prise fournie ne s'insère pas dans votre prise femelle, consultez un électricien pour le remplacement de la prise femelle obsolète.

**Warnung!** Der Sicherheitszweck des gepolten bzw. Schukosteckers ist zu berücksichtigen. Ein gepolter Stecker verfügt über zwei Pole, von denen einer breiter als der andere ist. Ein Schukostecker verfügt neben den zwei Polen noch über einen dritten Pol zur Erdung. Der breite Pol bzw. der Erdungspol dienen der Sicherheit. Wenn der zur Verfügung gestellte Stecker nicht in Ihren Anschluss passt, konsultieren Sie einen Elektriker, um den veralteten Anschluss zu ersetzen.

**¡Advertencia!** No eche por tierra la finalidad del tipo de enchufe polarizado con conexión a tierra. Un enchufe polarizado tiene dos espigas, una más ancha que la otra. Un enchufe con conexión a tierra tiene dos espigas iguales y una tercera espiga que sirve para la conexión a tierra. La espiga ancha, o la tercera espiga, sirven para su seguridad. Si el enchufe suministrado no encaja en el tomacorriente, consulte con un electricista para reemplazar el tomacorriente obsoleto.

**Aviso!** Não anule a finalidade da segurança da ficha polarizada ou do tipo ligação terra. Uma ficha polarizada tem duas lâminas sendo uma mais larga do que a outra. Uma ficha do tipo de ligação à terra tem duas lâminas e um terceiro terminal de ligação à terra. A lâmina larga ou o terceiro terminal são fornecidos para sua segurança. Se a ficha fornecida não couber na sua tomada, consulte um electricista para a substituição da tomada obsoleta.

**Avviso!** Non compromettere la sicurezza della spina polarizzata o con messa a terra. Una spina polarizzata ha due spinotti, di cui uno più largo. Una spina con messa a terra ha due spinotti e un terzo polo per la messa a terra. Lo spinotto largo o il terzo polo sono forniti per motivi di sicurezza. Se la spina fornita non si inserisce nella presa di corrente, contattare un elettricista per la sostituzione della presa obsoleta.



**Warning!** Since the Mains plug is used as the disconnection for the device, it must remain readily accessible and operable.

**Avertissement!** Puisque la prise principale est utilisée pour débrancher l'appareil, elle doit rester aisément accessible et fonctionnelle.

**Warnung!** Da der Netzstecker als Trennvorrichtung dient, muss er stets zugänglich und funktionsfähig sein.

**¡Advertencia!** Puesto que el enchufe de la red eléctrica se utiliza como dispositivo de desconexión, debe seguir siendo fácilmente accesible y operable.

**Aviso!** Dado que a ficha principal é utilizada como a desconexão para o dispositivo, esta deve manter-se prontamente acessível e funcional.

**Avviso!** Poiché il cavo di alimentazione viene usato come dispositivo di sconnessione, deve rimanere prontamente accessibile e operabile.



**Warning!** Protect the power cord from being walked on or pinched particularly at plugs, convenience receptacles, and the point where they exit from the device.

**Avertissement!** Protégez le cordon d'alimentation pour que l'on ne marche pas dessus ou qu'on le pince, en particulier au niveau des prises mâles, des réceptacles de convenance, et à l'endroit où il sort de l'appareil.

**Warnung!** Vermeiden Sie, dass auf das Netzkabel getreten oder das Kabel geknickt wird, insbesondere an den Steckern, den Steckdosen und am Kabelausgang am Gerät.

**¡Advertencia!** Proteja el cable de corriente para que no se le pise ni apriete, en especial cerca del enchufe, los receptáculos de conveniencia y el punto del que salen del equipo.

**Aviso!** Proteja o cabo de alimentação de ser pisado ou de ser comprimido particularmente nas fichas, em tomadas de parede de conveniência e no ponto de onde sai do dispositivo.

**Avviso!** Proteggere il cavo di alimentazione in modo che nessuno ci cammini sopra e che non venga schiacciato soprattutto in corrispondenza delle spine e del punto in cui esce dal dispositivo.



**Warning!** Unplug this device during lightning storms or when unused for long periods of time.

**Avertissement!** Débranchez cet appareil pendant les orages avec éclairso u s'il est inutilisé pendant de longues périodes.

**Warnung!** Das Gerät ist bei Gewitterstürmen oder wenn es über lange Zeiträume ungenutzt bleibt vom Netz zu trennen.

**¡Advertencia!** Desenchufe este dispositivo durante tormentas eléctricas o cuando no se lo utilice por largos periodos del tiempo.

**Aviso!** Desconecte este dispositivo da tomada durante trovoadas ou quando não é utilizado durante longos períodos de tempo.

**Avviso!** Utilizzare soltanto i collegamenti e gli accessori specificati e/o venduti dal produttore, quali il treppiedi e l'esoscheletro.



**Warning!** Do not open the chassis. There are no user-serviceable parts inside. Opening the chassis will void the warranty unless performed by an AJA service center or licensed facility.

**Avertissement!** Ne pas ouvrir le châssis. Aucun élément à l'intérieur du châssis ne peut être réparé par l'utilisateur. La garantie sera annulée si le châssis est ouvert par toute autre personne qu'un technicien d'un centre de service ou d'un établissement agréé AJA.

**Warnung!** Öffnen Sie das Gehäuse nicht. Keine der Geräteteile können vom Benutzer gewartet werden. Durch das Öffnen des Gehäuses wird die Garantie hinfällig, es sei denn, solche Wartungsarbeiten werden in einem AJA-Service-Center oder einem lizenzierten Betrieb vorgenommen.

**¡Advertencia!** No abra el chasis. El interior no contiene piezas reparables por el usuario. El abrir el chasis anulará la garantía a menos que se lo haga en un centro de servicio AJA o en un local autorizado.

**Advertência!** Não abra o chassi. Não há internamente nenhuma peça que permita manutenção pelo usuário. Abrir o chassi anula a garantia, a menos que a abertura seja realizada por uma central de serviços da AJA ou por um local autorizado.

**Avvertenza!** Non aprire lo chassis. All'interno non ci sono parti riparabili dall'utente. L'apertura dello chassis invaliderà la garanzia se non viene effettuata da un centro ufficiale o autorizzato AJA.



**Warning!** Disconnect the external AC power supply line cord(s) from the mains power before moving the unit.

**Avertissement!** Retirez le ou les cordons d'alimentation en CA de la source d'alimentation principale lorsque vous déplacez l'appareil.

**Warnung!** Trennen Sie die Wechselstrom-Versorgungskabel vom Netzstrom, bevor Sie das Gerät verschieben.

**¡Advertencia!** Cuando mueva la unidad desenchufe de la red eléctrica el/los cable(s) de la fuente de alimentación CA tipo brick.

**Advertência!** Remova os cabos CA de alimentação brick da rede elétrica ao mover a unidade.

**Avvertenza!** Scollegare il cavo dell'alimentatore quando si sposta l'unità.



**Warning!** Refer all servicing to qualified service personnel. Servicing is required when the device has been damaged in any way, such as power-supply cord or plug is damaged, liquid has been spilled or objects have fallen into the device, the device has been exposed to rain or moisture, does not operate normally, or has been dropped.

**Avertissement!** Référez-vous au personnel de service qualifié pour tout entretien. L'entretien est exigé quand l'appareil a été endommagé de quelque manière que ce soit, par exemple lorsque le cordon d'alimentation ou la prise sont endommagés, que du liquide a été versé ou des objets sont tombés dans l'appareil, que l'appareil a été exposé à la pluie ou à l'humidité, ne fonctionne pas normalement ou est tombé.

**Warnung!** Das Gerät sollte nur von qualifizierten Fachkräften gewartet werden. Eine Wartung ist fällig, wenn das Gerät in irgendeiner Weise beschädigt wurde, wie bei beschädigtem Netzkabel oder Netzstecker, falls Flüssigkeiten oder Objekte in das Gerät gelangen, das Gerät Regen oder Feuchtigkeit ausgesetzt wurde, nicht ordnungsgemäß funktioniert oder fallen gelassen wurde.

**¡Advertencia!** Consulte al personal calificado por cuestiones de reparación. El servicio de reparación se requiere cuando el dispositivo ha recibido cualquier tipo de daño, por ejemplo cable o espigas dañadas, se ha derramado líquido o se han caído objetos dentro del dispositivo, el dispositivo ha sido expuesto a la lluvia o humedad, o no funciona de modo normal, o se ha caído.

**Aviso!** Remeta todos os serviços de manutenção para o pessoal de assistência qualificado. A prestação de serviços de manutenção é exigida quando o dispositivo foi danificado mediante qualquer forma, como um cabo de alimentação ou ficha que se encontra danificado/a, quando foi derramado líquido ou caíram objectos sobre o dispositivo, quando o dispositivo foi exposto à chuva ou à humidade, quando não funciona normalmente ou quando foi deixado cair.

**Avviso!** Fare riferimento al personale qualificato per tutti gli interventi di assistenza. L'assistenza è necessaria quando il dispositivo è stato danneggiato in qualche modo, ad esempio se il cavo di alimentazione o la spina sono danneggiati, è stato rovesciato del liquido è stato rovesciato o qualche oggetto è caduto nel dispositivo, il dispositivo è stato esposto a pioggia o umidità, non funziona correttamente o è caduto.



**Warning!** Only use attachments and accessories specified and/or sold by the manufacturer.

**Avertissement!** Utilisez seulement les attaches et accessoires spécifiés et/ou vendus par le fabricant.

**Warnung!** Verwenden Sie nur Zusatzgeräte und Zubehör angegeben und / oder verkauft wurde durch den Hersteller.

**¡Advertencia!** Utilice solamente los accesorios y conexiones especificados y/o vendidos por el fabricante.

**Aviso!** Utilize apenas equipamentos/acessórios especificados e/ou vendidos pelo fabricante.

**Avviso!** Utilizzare soltanto i collegamenti e gli accessori specificati e/o venduti dal produttore.

# 5 Year Warranty and Liability Information

---

## Limited Warranty on Hardware.

---

AJA Video Systems, Inc. (AJA Video) warrants that the hardware product, not including software components, will be free from defects in materials and workmanship for a period of five years from the date of purchase. AJA Video provides a separate software warranty as part of the license agreement applicable to software components.

If the Customer brings a valid claim under this limited warranty for a hardware product (hereafter, a "product") during the applicable warranty period, AJA Video will, at its sole option and as the Customer's sole remedy for breach of the above warranty, provide one of the following remedies:

- Repair or facilitate the repair the product within a reasonable period of time, free of charge for parts and labor.
- Replace the product with a direct replacement or with a product that performs substantially the same function as the original product.
- Issue a refund of the original purchase price less depreciation to be determined based on the age of the product at the time remedy is sought under this limited warranty.

To obtain service under this warranty, the Customer must notify AJA Video of the defect before expiration of the warranty period and make suitable arrangements for the performance of service by contacting AJA Video support through the channels set forth on the support contacts web page at <https://www.aja.com/support>. Except as stated, the Customer shall bear all shipping, packing, insurance and other costs, excluding parts and labor, to effectuate repair. Customer shall pack and ship the defective product to a service center designated by AJA Video, with shipping charges prepaid. AJA Video shall pay to return the product to Customer, but only if to a location within the country in which the AJA Video service center is located. SOME JURISDICTIONS DO NOT ALLOW THE EXCLUSION OF IMPLIED WARRANTIES OR LIMITATIONS ON APPLICABLE STATUTORY RIGHTS OF A CONSUMER, SO SOME OR ALL OF THE TERMS OF THIS PARAGRAPH MAY NOT APPLY TO YOU.

## Limitation of Liability

---

Under no circumstances shall AJA video BE LIABLE IN ANY WAY FOR ANY LOST, CORRUPTED OR DESTROYED DATA, FOOTAGE OR WORK, OR FOR ANY OTHER INDIRECT, SPECIAL, INCIDENTAL OR CONSEQUENTIAL DAMAGES OR LOST PROFITS, OR FOR ANY THIRD PARTY CLAIM, IN CONNECTION WITH THE PRODUCT, WHETHER RESULTING FROM DEFECTS IN THE PRODUCT, SOFTWARE OR HARDWARE FAILURE, OR ANY OTHER CAUSE WHATSOEVER, EVEN IF AJA VIDEO HAS BEEN ADVISED OF THE POSSIBILITY OF SUCH DAMAGES. AJA VIDEO'S LIABILITY IN CONNECTION WITH THE PRODUCT SHALL UNDER NO CIRCUMSTANCES EXCEED THE PURCHASE PRICE PAID FOR THE PRODUCT. The foregoing limitations apply even if any remedy set forth in this LIMITED WARRANTY fails of its essential purpose. SOME JURISDICTIONS DO NOT ALLOW THE LIMITATION OF LIABILITY FOR PERSONAL INJURY, OR OF INCIDENTAL OR CONSEQUENTIAL DAMAGES, SO SOME OR ALL OF THE TERMS OF THIS PARAGRAPH MAY NOT APPLY TO YOU.

## Governing Law and Language; Your Rights.

---

This limited warranty is the only warranty provided by AJA Video on the hardware product. It supersedes all prior or contemporaneous understandings regarding such subject matter. No amendment to or modification of this warranty will be binding unless in writing and signed by AJA Video. The laws of the State of California, USA will govern this warranty and any dispute arising from it. Any translation of this Agreement is intended for convenience and to meet local requirements and in the event of a dispute between the English and any non-English versions, the English version of this warranty will govern. This limited warranty gives you specific legal rights and you may have other rights that vary from jurisdiction to jurisdiction, some of which are noted above.

# AJA Software License Agreement

---

AJA VIDEO SYSTEMS, INC.

THIS IS AN AGREEMENT BETWEEN YOU AND AJA VIDEO SYSTEMS, INC. ("AJA") THAT GOVERNS YOUR USE OF THE SOFTWARE ACCOMPANYING THIS LICENSE (E.G., AS INSTALLED ON THE DEVICE WITH WHICH THIS LICENSE IS PROVIDED).

The "AJA Software" referenced in this Agreement includes all such software, whether made available to you on disk, in read only memory, on any other media or in any other form, and all updates, corrections, enhancements and new versions of such software made available by AJA, together with all related documentation. BY INSTALLING OR USING THE AJA SOFTWARE, YOU ARE AGREEING TO BE BOUND BY THE TERMS OF THIS AGREEMENT. IF YOU DO NOT AGREE TO THE TERMS OF THIS AGREEMENT, DO NOT INSTALL OR USE IT AND, IF APPLICABLE, RETURN THE AJA SOFTWARE TO THE PLACE WHERE YOU OBTAINED IT FOR A REFUND.

1. License Grant. AJA hereby grants you a nonexclusive, personal, non-sublicenseable and limited license to install and use AJA Software on a computer or AJA device. The foregoing license also includes the right to make copies of the AJA Software in machine-readable form for installation and backup purposes only, and provided that each copy you make must include all copyright or other proprietary notices contained on the original.

2. Limitations. You may not decompile, reverse engineer, disassemble, modify, or create derivative works of the AJA Software or any part thereof except to the extent (if any) authorized by applicable law notwithstanding the foregoing restriction. You may not rent, lease, lend, loan, distribute or act as a service bureau or "cloud service" provider with respect to use of the AJA Software or any functionality thereof. THE AJA SOFTWARE IS NOT INTENDED FOR USE IN THE OPERATION OF NUCLEAR FACILITIES, AIRCRAFT NAVIGATION OR COMMUNICATION SYSTEMS, AIR TRAFFIC CONTROL SYSTEMS, LIFE SUPPORT MACHINES OR OTHER EQUIPMENT IN WHICH THE FAILURE OF THE AJA SOFTWARE COULD LEAD TO DEATH, PERSONAL INJURY, OR SEVERE PHYSICAL OR ENVIRONMENTAL DAMAGE.

3. Reservation of Rights. The AJA Software is protected by law, including without limitation copyright law. The AJA Software is licensed, not sold, to you. AJA and its licensors reserve all rights not expressly granted to you by this Agreement. You own the media on which the AJA Software is recorded but AJA and/or AJA's licensor(s) retain ownership of the AJA Software itself. You may not use the AJA Software for any illegal purpose.

4. Transfer. You may make a one-time permanent transfer of all of your license rights to the AJA Software to another person or entity, provided that: (a) you transfer all of the AJA Software, including all its component parts, original media, printed materials and this Agreement; (b) you do not retain any copies of the AJA Software, including any copies stored on a computer or other device; and (c) you transfer the AJA Software subject to this Agreement, and the person or entity receiving the AJA Software accepts the terms and conditions of this Agreement.

5. NFR (Not for Resale) Copies and Add-On Features: Notwithstanding anything to the contrary in this Agreement, (a) AJA Software that is labeled "Not for Resale" or otherwise provided to you on a promotional or demonstration basis may be used only for your demonstration, testing and evaluation purposes and may not be resold or transferred; and (b) AJA may make available certain software components ("Add-On Features") under separate terms and conditions, in which case those separate terms and conditions apply and the Add-On Features are not considered AJA Software under this Agreement.

6. Termination. Your rights in the AJA Software are conditioned on complying with this Agreement, and those rights (together with this Agreement) will terminate automatically, without notice from AJA, if you fail to comply with any term(s) of this Agreement. Upon termination of this Agreement, you must cease all use of the AJA Software and destroy all copies, full or partial, of the AJA Software in your possession or control.

7. Limited Warranty on AJA Software. If you comply with all terms of this Agreement and use the AJA Software in accordance with its documentation, and you install any patches or other updates made available to the AJA Software by AJA, AJA warrants that the AJA Software will perform substantially in accordance with its documentation for a period of ninety (90) days from the date of your original retail purchase. Your exclusive remedy under this warranty will be, at AJA's option, a refund of the purchase

price of the product containing the AJA Software or an update to or replacement of the AJA Software (or applicable component of it). THIS LIMITED WARRANTY AND ANY IMPLIED WARRANTIES ON THE AJA SOFTWARE INCLUDING, BUT NOT LIMITED TO, ANY WARRANTIES OF MERCHANTABILITY, OF SATISFACTORY QUALITY, OR OF FITNESS FOR A PARTICULAR PURPOSE, ARE LIMITED IN DURATION TO NINETY (90) DAYS FROM THE DATE OF ORIGINAL RETAIL PURCHASE. SOME JURISDICTIONS DO NOT ALLOW LIMITATIONS ON HOW LONG A WARRANTY LASTS, SO THE ABOVE LIMITATION MAY NOT APPLY TO YOU. THIS LIMITED WARRANTY GIVES YOU SPECIFIC LEGAL RIGHTS, AND YOU MAY ALSO HAVE OTHER RIGHTS WHICH VARY BY JURISDICTION.

8. Disclaimer of Other Warranties on AJA Software. EXCEPT FOR THE LIMITED WARRANTY ON AJA SOFTWARE SET FORTH ABOVE, AJA AND AJA'S LICENSORS (COLLECTIVELY REFERRED TO AS "AJA" FOR THE PURPOSES OF SECTIONS 8 AND 9) HEREBY DISCLAIM ALL WARRANTIES AND CONDITIONS WITH RESPECT TO THE AJA SOFTWARE, WHETHER EXPRESS, IMPLIED OR STATUTORY, INCLUDING, BUT NOT LIMITED TO, THE IMPLIED WARRANTIES AND/OR CONDITIONS OF MERCHANTABILITY, OF SATISFACTORY QUALITY, OF FITNESS FOR A PARTICULAR PURPOSE, OF ACCURACY, AND OF QUIET ENJOYMENT. FURTHER, AJA DOES NOT MAKE ANY WARRANTY REGARDING NON-INFRINGEMENT OF THIRD PARTY RIGHTS. SUBJECT ONLY TO THE LIMITED WARRANTY SET FORTH IN SECTION 7, YOU EXPRESSLY ACKNOWLEDGE AND AGREE THAT USE OF THE AJA SOFTWARE IS AT YOUR SOLE RISK. AJA DOES NOT WARRANT AGAINST INTERFERENCE WITH YOUR ENJOYMENT OF THE AJA SOFTWARE, THAT THE AJA SOFTWARE WILL MEET YOUR REQUIREMENTS, THAT THE OPERATION OF THE AJA SOFTWARE WILL BE UNINTERRUPTED OR ERROR-FREE, OR THAT DEFECTS IN THE AJA SOFTWARE WILL BE CORRECTED. NO ORAL OR WRITTEN INFORMATION OR ADVICE GIVEN BY AJA OR AN AJA AUTHORIZED REPRESENTATIVE WILL CREATE A WARRANTY. SOME JURISDICTIONS DO NOT ALLOW THE EXCLUSION OF IMPLIED WARRANTIES OR LIMITATIONS ON APPLICABLE STATUTORY RIGHTS OF A CONSUMER, SO SOME OR ALL OF THE TERMS OF THIS PARAGRAPH MAY NOT APPLY TO YOU.

9. Limitation of Liability. TO THE EXTENT NOT PROHIBITED BY LAW, IN NO EVENT WILL AJA BE LIABLE FOR PERSONAL INJURY, OR ANY INCIDENTAL, SPECIAL, INDIRECT OR CONSEQUENTIAL DAMAGES OR LOST PROFITS WHATSOEVER, INCLUDING, WITHOUT LIMITATION, DAMAGES FOR LOSS OF DATA, BUSINESS INTERRUPTION OR ANY OTHER COMMERCIAL DAMAGES OR LOSSES, ARISING OUT OF OR RELATED TO YOUR USE OR INABILITY TO USE THE AJA SOFTWARE, HOWEVER CAUSED, REGARDLESS OF THE THEORY OF LIABILITY (E.G., WHETHER UNDER CONTRACT, TORT OR OTHERWISE) AND EVEN IF AJA HAS BEEN ADVISED OF THE POSSIBILITY OF SUCH DAMAGES. IN NO EVENT WILL AJA'S TOTAL LIABILITY TO YOU FOR ALL DAMAGES (INCLUDING WITHOUT LIMITATION BREACH OF WARRANTY) EXCEED THE AMOUNT OF FIFTY DOLLARS (\$50.00). THE FOREGOING LIMITATIONS WILL APPLY EVEN IF THE ANY REMEDY SET FORTH IN THIS AGREEMENT FAILS OF ITS ESSENTIAL PURPOSE. SOME JURISDICTIONS DO NOT ALLOW THE LIMITATION OF LIABILITY FOR PERSONAL INJURY, OR OF INCIDENTAL OR CONSEQUENTIAL DAMAGES, SO SOME OR ALL OF THE TERMS OF THIS PARAGRAPH MAY NOT APPLY TO YOU.

10. Export Law Assurances. You may not use or otherwise export or reexport the AJA Software except as authorized by United States law and the laws of the jurisdiction in which the AJA Software was obtained. In particular, but without limitation, the AJA Software may not be exported or re-exported (a) into (or to a national or resident of) any U.S. embargoed countries, or (b) to anyone on the U.S. Treasury Department's list of Specially Designated Nationals or the U.S. Department of Commerce Denied Persons List or Entity List or any similar legal designation. By using the AJA Software, you represent and warrant that you are not located in, under control of, or a national or resident of any such country or on any such list.

11. Government End Users. The AJA Software including its documentation is a "Commercial Item", as that term is defined at 48 C.F.R. § 2.101, consisting of "Commercial Computer Software" and "Commercial Computer Software Documentation", as such terms are used in 48 C.F.R. § 12.212 or 48 C.F.R. § 227.7202 (or their successors), as applicable. Consistent with these provisions, the AJA Software is licensed to U.S. Government end users (a) only as a Commercial Item and (b) with only those rights as are granted to all other end users pursuant to this Agreement. Unpublished-rights reserved under the copyright laws of the United States.

12. Controlling Law and Severability. This Agreement will be governed by and construed in accordance with the laws of the State of California, as applied to agreements entered into and to be performed entirely within California between California residents. This Agreement will not be governed by the United Nations

Convention on Contracts for the International Sale of Goods, the application of which is expressly excluded. If for any reason a court of competent jurisdiction finds any provision, or portion thereof, to be unenforceable, the remainder of this Agreement will continue in full force and effect.

13. Complete Agreement; Governing Language. This Agreement constitutes the entire agreement between the parties with respect to the use of the AJA Software licensed hereunder and supersedes all prior or contemporaneous understandings regarding such subject matter. No amendment to or modification of this Agreement will be binding unless in writing and signed by AJA. Any translation of this Agreement is intended for convenience and to meet local requirements and in the event of a dispute between the English and any non-English versions, the English version of this Agreement will govern.

# Index

---

## Symbols

3G-SDI Mode 15  
4K/UHD LFR 15

## A

Acquiring AJA Mini-Config 7  
AJA Mini-Config Control 4, 14  
AJA Software License Agreement 33  
AJA Support 2  
Assembly 21  
Audio Tab Screen 18

## B

Bits Per Pixel 12  
Block Diagram 5

## C

CLL  
    Maximum 17  
Colorimetry Override 18  
Color Range 14  
CTA-861.3  
    Static Metadata Descriptors 16

## D

DA Function 15  
Default Operation 4  
DM Lum 17

## E

EDID Tab Screen 13  
Embed into SDI 19  
Enable PtoPsF 15

## F

Features 5  
FLL  
    Maximum 17  
Frame Rate 16

## G

Genlock 15

## H

HDMI 2.0a  
    Static Metadata Descriptors 16  
HDMI In HDR Metadata 17  
HDR Infoframe Detected 17  
HDR Metadata Tab Screen 16  
High Dynamic Range  
    HDR Tab Screen 16

## I

Info Tab Screen 12, 18, 20  
Input Tab Screen 12

Installation 6, 7, 10, 11  
I/O Connections 6

## M

Mapping 15  
Maximum: CLL 17  
Maximum: FALL 17  
Mini-Config  
    Installation on Mac 8  
    Installation on PC 7  
    Startup on Mac 9  
    Startup on PC 9

## N

Name 21

## O

Output Overrides 17  
Output Tab Screen 14  
Overview 4, 5

## P

Pad/Crop 15  
Preferred Video Format 13  
Preprocess 12

## R

Red, Green, Blue, White Point 17  
RGB Range 12

## S

Saving Setups 10  
SDR/HDR Overrides 18  
Serial Number 21  
SRC 18

## T

Type 21

## U

Update Tab Screen 19

## Y

YCbCr Support 13