

DRM2

Mini-Converter Rack-Mount Frame

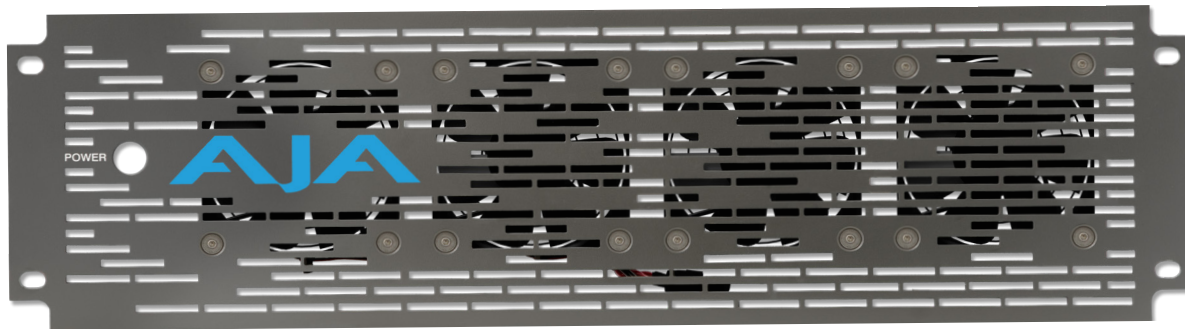

(Mini-Converters Sold Separately)



(Optional Active Faceplate)

Installation and Operation Guide

Notices

Trademarks

AJA® and Because it matters.® are registered trademarks of AJA Video Systems, Inc. for use with most AJA products. AJA™ is a trademark of AJA Video Systems, Inc. for use with recorder, router, software and camera products. Because it matters.™ is a trademark of AJA Video Systems, Inc. for use with camera products.

Corvid Ultra®, Io®, Ki Pro®, KONA®, KUMO®, ROI® and T-Tap® are registered trademarks of AJA Video Systems, Inc.

AJA Control Room™, KiStor™, Science of the Beautiful™, TruScale™, V2Analog™ and V2Digital™ are trademarks of AJA Video Systems, Inc.

All other trademarks are the property of their respective owners.

Copyright

Copyright © 2023 AJA Video Systems, Inc. All rights reserved. All information in this manual is subject to change without notice. No part of the document may be reproduced or transmitted in any form, or by any means, electronic or mechanical, including photocopying or recording, without the express written permission of AJA Video Systems, Inc.

Contacting AJA Technical Support or Sales

Please have all pertinent information at hand prior to contacting AJA support or sales.

Support Telephone: +1.530.271.3190

Support Website: <https://www.aja.com/support/contact>

Support Email: support@aja.com

Sales Email: sales@aja.com

Shipping Address: AJA Video Systems
180 Litton Drive
Grass Valley, CA 95945, USA

Contents

Notices	2
Trademarks	2
Copyright	2
Contacting AJA Technical Support or Sales	2
Chapter 1 – Introduction	4
Overview	4
Mini-Converter Frame for 19-inch Racks	4
High Capacity	4
Features	5
Front Faceplate	5
Chapter 2 – Installation	7
Included in the Box	7
Basic Order	7
Parts Available Separately	7
Overview of Installation	8
Rack Mount Frame with Carrier Slots	8
Mini-Converter Carriers	8
Twelve Mini-Converters Example Configuration	9
Installation	9
Mounting Converters onto Carriers	9
Installing Converters into DRM2 Frame	11
Attach Passive Faceplate	12
Attach Active Faceplate	13
Uninstallation	14
Remove Passive Faceplate	14
Remove Active Faceplate	14
Remove Carrier from DRM2 Frame	15
Remove Rear-Mounted Converter from Carrier	15
Remove Bottom-Mounted Converter from Carrier	16
Special Case Installations	16
Mounting Converters with DIP Switches	16
Stacking FiDO Converters Two-High	16
USB Connections	19
USB Hub	19
AJA Mini-Config USB Device Select	19
Appendix A – Specifications	20
DRM2 Tech Specs	20
Appendix B – Safety and Compliance	21
Warranty and Liability Information	29
Index	30

Chapter 1 – Introduction

Overview

Mini-Converter Frame for 19-inch Racks

DRM2 is a 3RU rack mount frame engineered to professionally mount and power up to twelve (12) AJA Mini-Converters of any current size and form-factor. The DRM2 delivers total power of up to 200 Watts.

The frame includes a 110/220VAC (12-Amp) power supply. Twelve +5V power leads are provided via a DC Wiring Harness from the main power supply to power the converters.

Figure 1. DRM2 with twelve Mini-Converters mounted on Carriers



Figure 2. 19" rack-mounted DRM2 shown with (optional) Active Faceplate



High Capacity

Here are some examples of what is possible with the DRM2 using only 3RU of rack space:

- 12 independent channels of 4K HDMI to 12G-SDI or 12G-SDI to 4K HDMI conversion
- 12 independent scan-conversion channels
- 12 independent Up/Down/Cross conversion channels
- Up to 60 channels of HD or SD sync distribution utilizing two GEN10s and ten 3GDAs or C10DAs
- 48 channels of 3G or 12G SDI to Fiber or Fiber to SDI conversion

Features

- 3RU form-factor allows all AJA Mini-Converters to fit cleanly in the chassis.
- Flexible 12-slot frame design.
- Modular “Carrier” based Mini-Converter mounts are rugged, simple to use, and easy to access from the front or rear of the chassis. Twelve Carriers are included with the DRM2 frame, one for each slot. Additional/replacement Carriers are available.
- The powered Active Faceplate offers four fans for maximum cooling in higher ambient temperature installations.
- DRM2 200W Power Supply supports any combination of up to 12 AJA Mini-Converters.
- DRM2 also supports up to 24 AJA FiDO and FiDO-2(T/R/TR) Mini-Converters by using optional DC power Y-Cables, and mounting pairs of FiDOs on single Carriers.
- Main DC Power Harness included has thirteen D5/10-PC power connectors. Twelve of the D5/10-PC power connectors are to be utilized by the Mini-Converters, and one is reserved for the (optional) Active Faceplate.
- Modular Power Supply Connector also allows users the option to create custom cabling (within power specifications). For example, cables with more D5/10-PC connectors could be made for higher density installations, upon engineering review.

Front Faceplate

Two types of front faceplates are available for the DRM2 frame: a Passive Faceplate and an Active Faceplate.

Passive Faceplate

The DRM2 ships with a standard Passive Faceplate with ventilation holes. For users that want to upgrade their passive faceplate to the active version, the Active Faceplate is also available as a standalone part. See ["Parts Available Separately" on page 7](#).

The Passive Faceplate is sufficient for rack installations which provide their own cooling, or for when lower wattage Mini-Converters are installed and lower ambient temperatures are present.

Figure 3. Passive Faceplate

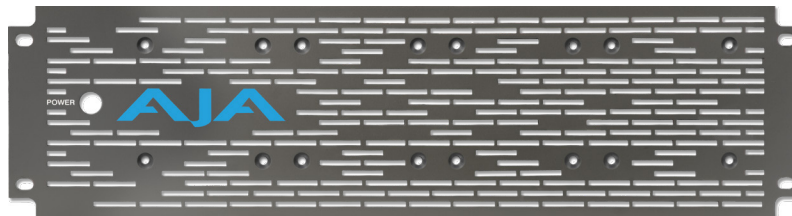

Active Faceplate

The Active Faceplate enables the DRM2 frame to be used with higher wattage consuming Mini-Converters, and/or to be used in higher ambient temperature environments.

The DRM2-AP product configuration ships the Mini-Converter rack frame together with an Active Faceplate having four cooling fans.

Figure 4. Active Faceplate

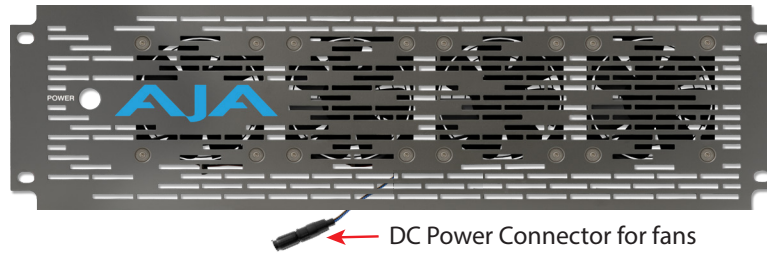

The Active Faceplate allows for a high-density installation of AJA's most powerful Mini-Converters, without concern for heat soak. The Active Faceplate connects to the DRM2 +5V DC power supply using any available DC power connector found on the DRM2's DC Power Harness, although one is provided near the middle of the harness for this use.

If the ambient temperature is under 30C, an Active Faceplate is recommended if power consumption exceeds 100W. If the ambient temperature is over 30C, then an Active Faceplate is recommended if power consumption exceeds 75W. Please consult the Tech Specs of your Mini-Converters to calculate expected power consumption.

Figure 5. Active Faceplate Fans and Power Connector

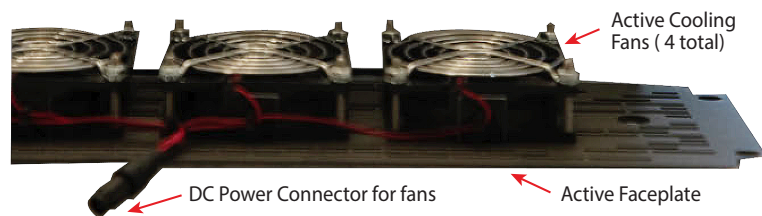

Both DRM2 faceplate types have four "inner" mounting holes for the faceplate, in addition to the four "outer" 19" rack-mounting holes for the DRM2 frame.

Figure 6. Separate faceplate and rack mount screw holes

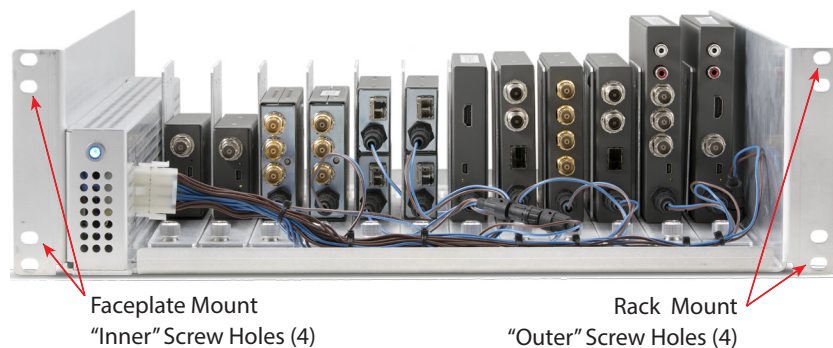

Both sets of holes may use the same size 19" rack screws.

NOTE: 19" rack rails vary in design, so use the fasteners which your rack provides.

This design allows removal and replacement of the faceplate without removing the DRM2 from the rack. This allows easy access to Mini-Converters and their cabling from the front. The above example shows all Mini-Converters connected to the DC Power Harness.

Chapter 2 – Installation

Included in the Box

Basic Order

Table 1. Shipping Contents for DRM2 or DRM2-AP Basic Order

Item	Quantity	Notes
DRM2 Rack Mount Frame	1	19" rack mount frame for AJA mini-converters
Passive or Active Faceplate	1	Passive Faceplate (with DRM2 order) - or - Active Faceplate (with DRM2-AP order)
Carrier	12	Carriers include captive No-Tools secure screws
Anti-vibration screw	12	10-32 x 0.187 Phillips Pan Head Secures rear of Carrier for anti-vibration use
Mini-Converter rear mounting screw	12	4-40 x 0.312 Phillips Flat Head Secures rear of Mini-Converter to Carrier
Mini-Converter bottom mounting screw	12	2-56 x 0.250 Phillips Flat Head Secures bottom of Mini-Converter to Carrier

Parts Available Separately

Table 2. Separately Orderable Parts

AJA Part Number	Item	Quantity	Notes
DRM2-AFP (Active Faceplate)	Active Faceplate	1	Faceplate includes four installed fans
DRM2-CH12-R0 (Carrier Twelve Pack)	Carrier	12	Include captive No-Tools secure screws
	Rear-mounting screw	24	4-40 x 0.312 Phillips Flat Head
	Bottom-mounting screw	24	2-56 x 0.250 Phillips Flat Head
DRM2-CH-R0 (Carrier Single Pack)	Carrier	1	Includes captive No-Tools secure screw
	Rear-mounting screw	2	4-40 x 0.312 Phillips Flat Head
	Bottom-mounting screw	2	2-56 x 0.250 Phillips Flat Head
DRM2-YC-R0 (Power Cable Adapter)	DC Power Y-Cable	1	Adds a second +5VDC DWP male connector to any single DWP connector
DRM2-YC12-R0 (Expansion Kit Upgrade Kit)	DC Power Y-Cable	12	Adds 12 more +5VDC DWP male connectors to the DC Power Harness
	Rear-mounting screw	24	4-40 x 0.312 Phillips Flat Head

Overview of Installation

Rack Mount Frame with Carrier Slots

The DRM2 is a standard 19-inch, 3-RU tall, 15" deep rack mount frame with 12 Carrier Slots, into which Mini-Converter Carrier mounting brackets slide into and are secured.

Figure 7. DRM2 with empty Carriers in Carrier Slots

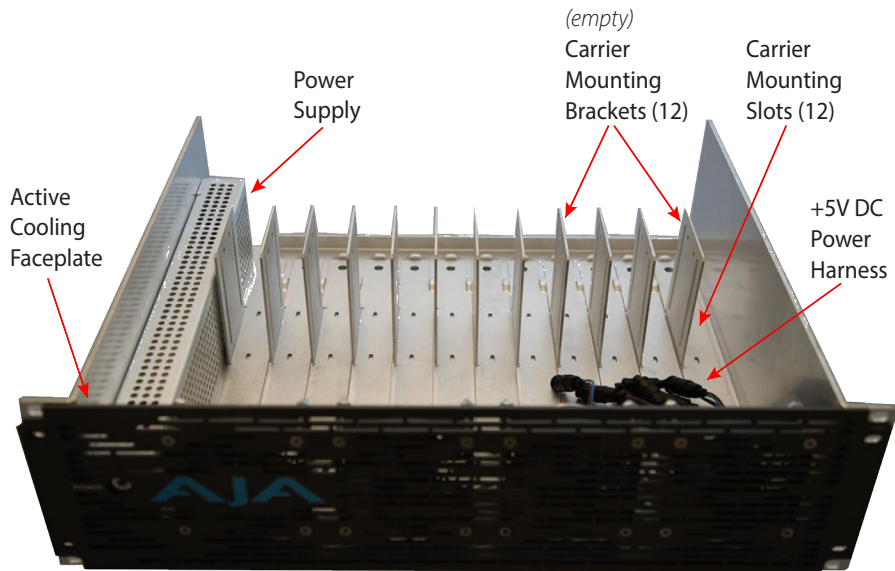

Mini-Converter Carriers

Mini-Converters are not mounted directly into the DRM2 frame. They are first attached to the Mini-Converter Carrier mounting brackets. The Carriers each include screws for mounting mini-converters to them, as well as a Carrier Rear Screw for optional anti-vibration use.

Figure 8. Mini-Converter Carrier mounting bracket and screws

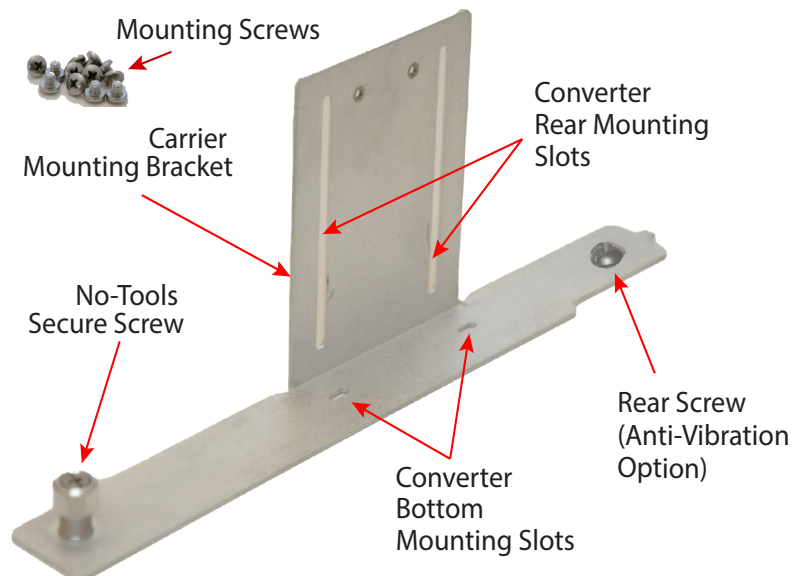

Twelve Mini-Converters Example Configuration

Below find an example of 12 AJA Mini-Converters of various sizes installed into a single DRM2 frame.

Figure 9. DRM2 with 12 AJA Mini-Converters installed

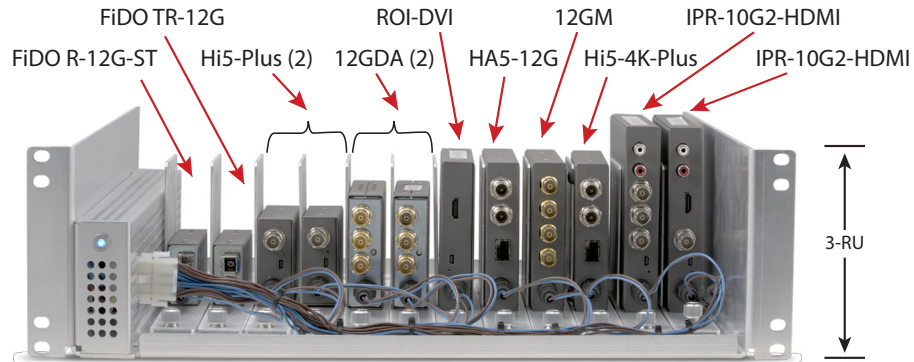

NOTE: The above example is for illustration purposes only, and is not intended to represent a specific application. Only DC power is shown connected, for clarity.

NOTE: For details on the example AJA mini-converter products shown above, see: <https://www.aja.com/nav/products-mini-converters>

Installation

DRM Carriers may be shipped pre-installed in the DRM2 frame. If so, first time converter installation requires removing the Carriers from their Carrier Slots inside the frame, in order to subsequently mount converters onto them. See ["Remove Carrier from DRM2 Frame" on page 15](#); then continue on below.

Mounting Converters onto Carriers

Which of two alternative methods to use for mounting converters onto Carriers depends upon the particular model of Mini-Converter. When a particular model converter has two threaded rear-mounting holes, then the provided rear-mounting screws can be used through the carrier mounting slots in the Carrier's vertical bracket. See ["Rear-Mounting Mini-Converters" on page 10](#).

Other Mini-Converter models which don't have rear-mounting holes, will have to be attached through the Carrier's bottom plate and into the bottom of the Mini-Converter housing. You will reuse the converter's bottom housing screws, or use those provided. See ["Bottom-Mounting Mini-Converters" on page 10](#).

Use the appropriate method for each Mini-Converter being mounted into the DRM2. Procedures for both methods are detailed below.

Figure 10. Two methods of attaching Mini-Converters onto Carriers

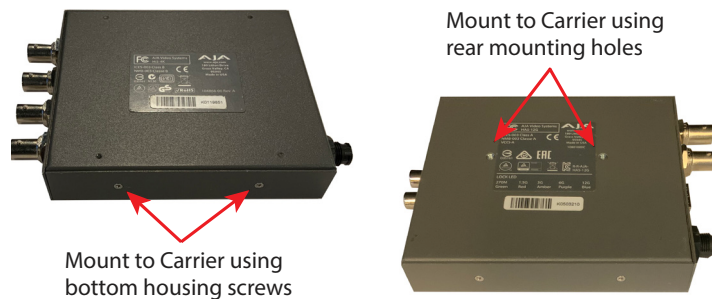

Rear Mounting Mini-Converters

For each Mini-Converter having rear mounting holes which is to be installed into the DRM2 frame, follow the below steps:

1. Attach the Mini-Converter to a Carrier bracket using two of the Phillips mounting screws provided. Adjust the screw positions through the converter mounting slots in order to align with the mounting holes found in the back of the particular converter. Do not tighten the screws completely.
2. Slide the converter all the way down against the Carrier bracket bottom (suggested).
3. Tighten the mounting screws to secure the converter onto the Carrier. Do not over-tighten.

Figure 11. Rear-mounting a Mini-Converter onto a Carrier bracket

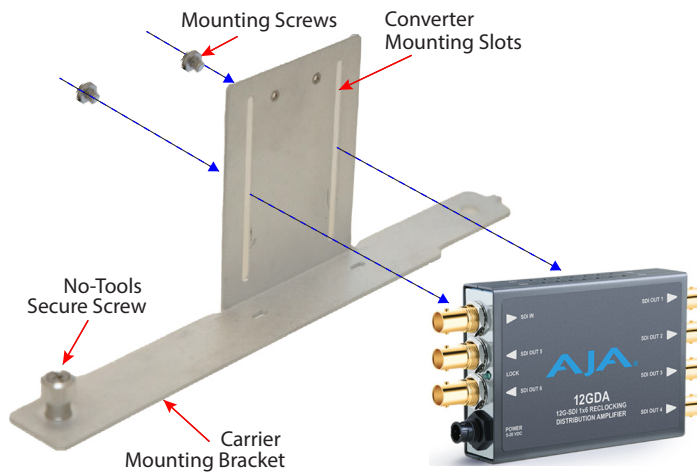
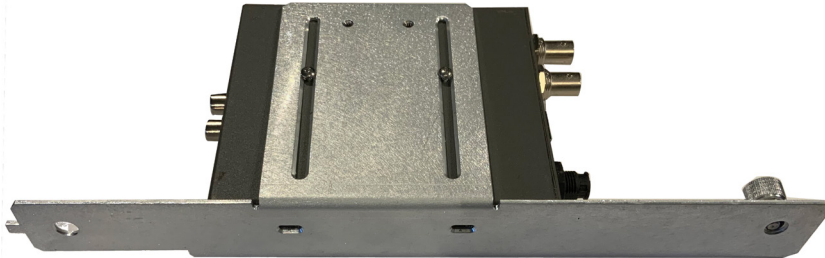

Figure 12. Example of a Mini-Converter correctly rear-mounted on a Carrier



Bottom Mounting Mini-Converters

For each Mini-Converter which does not have the two rear mounting holes, attach it instead through the bottom of a Carrier and into the converter housing as follows:

1. Remove the two small Phillips screws from the bottom edge of the converter housing, and keep them on hand.
2. Position the Mini-Converter onto the Carrier, orienting its DC power connection towards the front (nearest the attached No-Tools Secure Screw.)
3. Replace the converter bottom housing screws through the Carrier bottom mounting slots and into the converter's bottom housing's screw holes. The finished Mini-Converter/Carrier assembly should look like this:

Figure 13. Mini-Converter correctly bottom-mounted on a Carrier

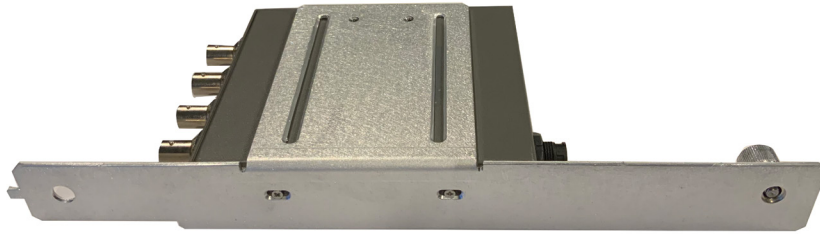

Installing Converters into DRM2 Frame

Overview

After mounting your Mini-Converter(s) onto Carrier bracket(s), you are ready to install your converter(s) into the DRM2 frame.

If you are installing Converters into a frame having a faceplate previously attached:

Temporarily remove faceplate - you will remove the DRM2 faceplate and set it aside. Removing a Passive Faceplate is simple to do, however handling an Active Faceplate requires careful attention to its power cable.

Continue below when there is no faceplate mounted on the frame:

Install Carriers with converters - you will mount Carriers into their desired Carrier Slots in the DRM2 frame and secure them. Carriers must have Mini-Converters previously mounted on them.

Install faceplate - you will reinstall the faceplate over the DRM2 and into the rack rails behind it. The Active Faceplate requires attention to its power connection.

Installing Carriers with Converters into the DRM2 Frame

1. Align and loosely place a Carrier, together with its previously mounted Mini-Converter, into an empty Carrier slot in the DRM2 frame. Do not try to align or tighten the No-Tools Secure Screw yet, that's for a later step; (after first making sure the Carrier rear is installed correctly, as described below.)

CAUTION: While placing a Carrier into a slot position in the DRM2 frame, be sure to keep all DC power (and any other) cables above the Carrier. Avoid letting wires get caught under a Carrier.

Figure 14. Add Carrier with Mini-Converter into slot in DRM2 Frame



Figure 15. Align, insert and secure rear of Carrier

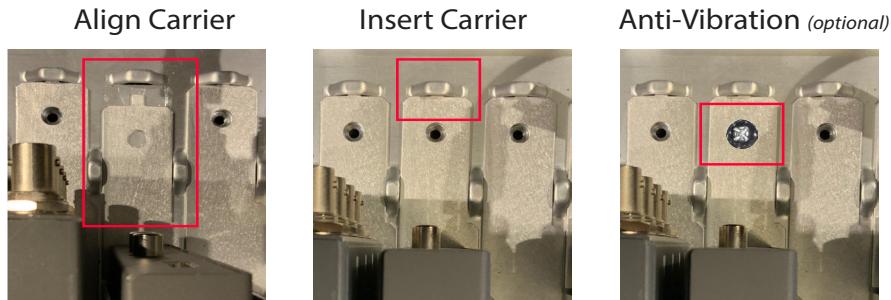

2. Align the rear tab on the Carrier with the small slot on the frame.
3. Slide the Carrier fully back.
4. (Optional) Secure the Carrier at the rear by using a provided Carrier Rear Screw. Do not over-tighten.

NOTE: Add the anti-vibration Rear Screw to a Carrier when the DRM2 rack is to be used in a high-vibration environment (including mobile, or otherwise).

CAUTION: Do not over-tighten the Rear Screw.

5. Clear any wires that have been inadvertently caught underneath a Carrier.

Figure 16. Clear wires, secure front of Carrier and connect cables

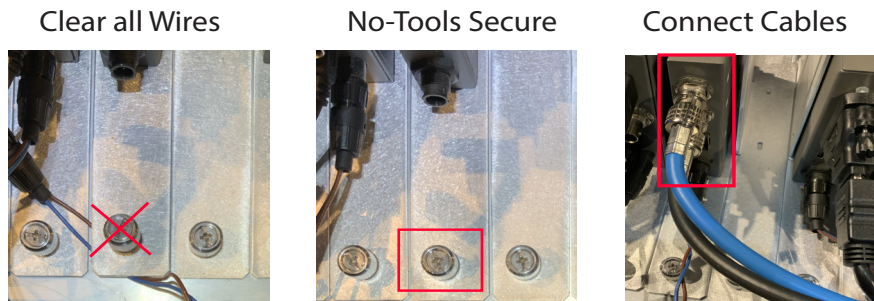

CAUTION: Do not allow any wires to get inadvertently caught underneath the Carrier. This could damage the wires or prevent the Carrier from being properly secured.

6. Align and hand-tighten the attached No-Tools Secure Screw at the front of the Carrier.
7. Attach the Mini-Converter DC power connector to the main DC Power Harness (or to a Y-Cable if used).

NOTE: The DWP/DWP-U/DWP-U-R1 power supplies which are supplied with all AJA Mini-Converters can alternatively be used if desired, rather than the supplied DRM2 frame's main DC Power Harness. Use of separate DC power supplies is rarely needed however, given the DRM2 200W power supply.

8. Attach data and AV cables to the Mini-Converter as appropriate.

Repeat steps #1 through #8 above for each Mini-Converter Carrier that you wish to install into the DRM2 frame.

Attach Passive Faceplate

1. Position the Passive Faceplate over its corresponding mounting holes in the DRM2.

CAUTION: As you position the faceplate, prevent DC power, or any other cables, from being inadvertently caught between the faceplate and DRM2 frame. Check this before tightening the rack screws.

2. Use four rack-mounting screws to secure the faceplate into the rack and over the DRM2.

Figure 17. Rack-Mounted DRM2 with Passive Faceplate installed

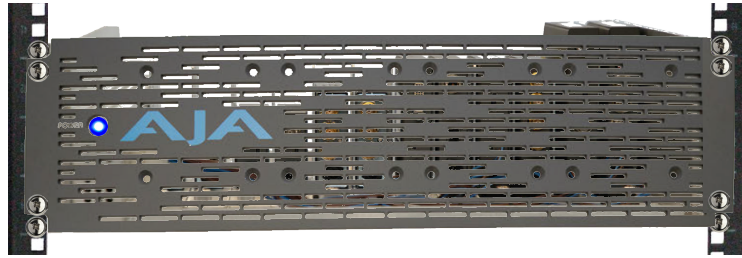

Attach Active Faceplate

1. Position the Active Faceplate horizontally just below the DRM2, fans facing upwards in order to bring its power cable close to the DRM2 main DC Power Harness.
2. While supporting the faceplate, connect its DC power connector to any available connector on the DC Power Harness (or to a Y-Cable if used). Ideally, use the 13th connector on the DRM2 DC Power Harness because its middle location in the harness keeps the faceplate cable short.

WARNING: Do not allow the Active Faceplate to fall, nor to hang by its DC power connection. This could damage the faceplate DC power connector and/or the DC Power Harness.

3. While still supporting the faceplate, rotate the faceplate up so that it is in its vertical mounting orientation.
4. Align the faceplate over the faceplate mounting holes in the DRM2.

WARNING: While positioning the Active Faceplate and before fully securing it, be careful to not allow any DC power wires to accidentally push into a fan (i.e. inside of a fan's safety grill). This could cause a loud fan noise, or cause a failure of the fan, or cause other electrical damage.

Figure 18. Keep DC power and any other wires from getting inside fan

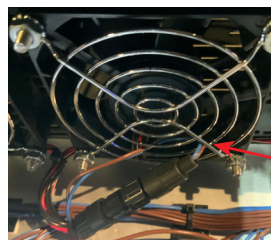

Do Not
allow wire
inside fan



Good Practice

A suggested good practice for the Active Faceplate power connection is shown above right: tucked underneath a fan housing at bottom.

5. While still supporting the faceplate, use four rack screws to attach the faceplate through the DRM2 and into the rack rails.

Figure 19. Attaching an Active Faceplate



6. If you have access inside the DRM2 after the faceplate has been secured, such as through an open rack in the rear, then double-check that all fans are clear of wires by inspecting them from behind. If found, re-position the DC wires as needed.
7. While still accessing the rear of the rack, you can also check that no wires were inadvertently pinched between the faceplate and the DRM2 frame. If any pinched wires are found, simply loosen the rack mount screws slightly, remove the wire(s) then re-tighten the rack screws.
8. If not previously connected, connect the AC Power Cord to the rear of the DRM2 power supply and plug it into a suitable 100–240VAC outlet.

Uninstallation

Remove Passive Faceplate

1. Remove the four inner screws which hold the faceplate on the DRM2. Keep these screws on hand for re-installation later.
2. Remove the faceplate from the DRM2 and set it aside.

Remove Active Faceplate

1. Remove the four inner screws which hold the faceplate on the DRM2. Keep these screws on hand for re-installation later.
2. While removing the mounting screws, be sure to also support the faceplate to prevent it from falling while still connected to the main DC Power Harness.

Figure 20. Removing an Active Faceplate



WARNING: Do not allow the Active Faceplate to fall, nor to hang by its DC power connection. This could damage the faceplate DC power connection and/or the main DC Power Harness.

3. Remove the faceplate from the DRM2 frame, while supporting the faceplate.
4. While still supporting the faceplate, unplug the faceplate's DC power connector from the DRM2 DC Power Harness. Do this by gently twisting counterclockwise and then pulling the connector out. If possible when pulling it out, hold by the connector instead of by the cable.

Figure 21. Locate and unplug the Active Faceplate DC power connector



5. Set aside the Active Faceplate for re-installation later.

WARNING: *When handling an Active Faceplate, keep it free of contact from dust, particles, wire fragments or other debris, because such contamination could cause a loud fan noise, or cause a fan failure when power is applied.*

Remove Carrier from DRM2 Frame

NOTE: When working with a frame full of converters it is generally ideal, when possible to have access from both the front and the rear of the DRM2 frame.

1. Remove the DRM2 faceplate, if one is attached to the frame.
2. If you have access to the rear of the frame, such as through an open chassis, you may be able to access and remove a Carrier from the rear of the frame only. Depending upon the ease of the access, and how many other converters are installed in the frame, this may or may not be convenient.
3. Disconnect DC power, USB, fiber and/or AV cables from the mounted Mini-Converters (if any).
4. Remove the Carrier Rear Screw (if present). Set it aside for re-installation later.
5. Loosen the No-Tools Secure Screw at the front of the Carrier, until the Carrier comes loose.
6. Slide the Carrier slightly forward (towards the front of the frame) to disengage the Carrier from the rear alignment slot.
7. Lift the Carrier up and out of the frame.

NOTE: Avoid catching the Carrier on other cables inside the DRM2 as you move it out of the frame.

Remove Rear-Mounted Converter from Carrier

1. If not previously done, remove the Carrier from the DRM2 frame (see ["Remove Carrier from DRM2 Frame" on page 15.](#))
2. From the rear side of the Carrier's vertical bracket, remove the rear-mounting screws from the converter, and set them aside for future use.
3. Remove the converter from Carrier.

Remove Bottom-Mounted Converter from Carrier

1. If not previously done, remove the Carrier from the DRM2 frame (see ["Remove Carrier from DRM2 Frame" on page 15.](#))
2. From the underside of the Carrier, remove the bottom housing screws from the Mini-Converter, and set them aside.
3. Remove the converter from the Carrier.
4. Re-insert the bottom housing screws into the carrier bottom edge of its housing.

Special Case Installations

Mounting Converters with DIP Switches

If the Mini-Converter being installed has DIP switches, these are usually found on the rear of the converter, located between the two rear mounting holes. The DIP switches will be covered by the Carrier's converter mounting bracket after the converter is installed onto it, making DIP adjustments impossible (while mounted). Thus a best practice is to adjust your DIP switches first, then mount the converter onto the Carrier.

Figure 22. Mounting a Mini-Converter with DIPS onto a Carrier bracket

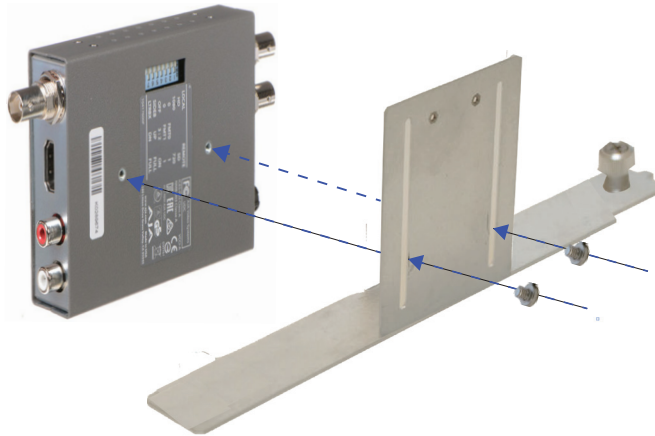

When the Mini-Converter is connected to a host computer, in most cases the same functional adjustments (and more) can be made using AJA's Mini-Config software alone, instead of using the physical DIP switches.

NOTE: See ["USB Connections" on page 19.](#)

Stacking FiDO Converters Two-High

Two FiDO Mini-Converters, given their thermal characteristics, may be mounted directly on top of each other on a single DRM2 Carrier and thus the two converters will use only one Carrier slot in the DRM2 frame. Only the AJA FiDO and FiDO-2(T/R/TR) Mini-Converters are certified for this vertical-stacked configuration on a Carrier.

Below is an example DRM2 configuration with two stacked FiDOs in the frame.

Figure 23. DRM2 with four FiDO Mini-Converters using two Carrier Slots

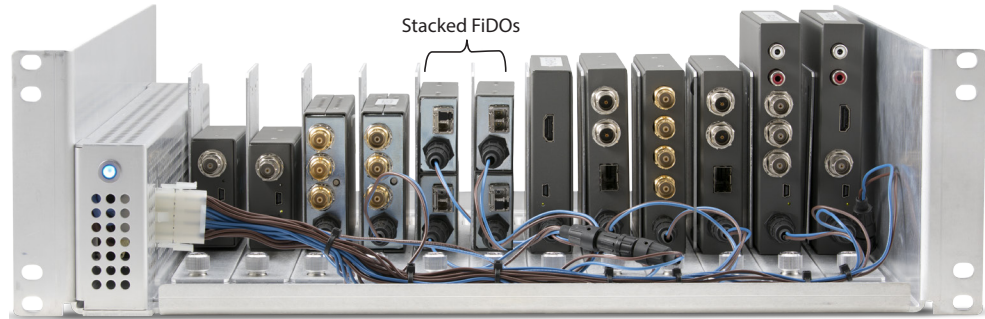
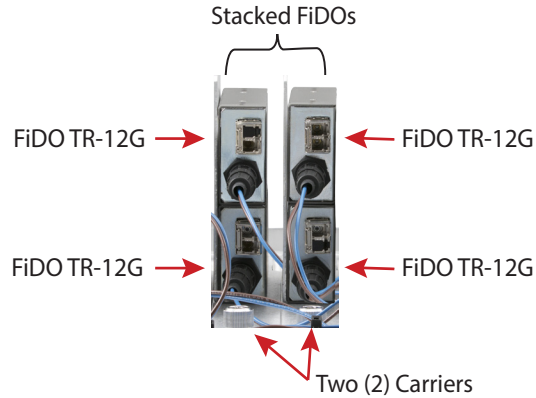

Figure 24. Four FiDO TR-12G Mini-Converters using two Carrier Slots



FiDOs have rear mounting holes, so those are used to attach them to Carriers.

1. Use the converter mounting slots and mounting screws to install the first FiDO Mini-Converter to the bracket.
2. Slide it to the bottom against the Carrier.
3. Tighten its mounting screws.
4. Install the second FiDO above the first one, using another pair of mounting screws through the slots into the rear of the second FiDO.

Figure 25. Stacking two FiDO Mini-Converters onto one Carrier bracket

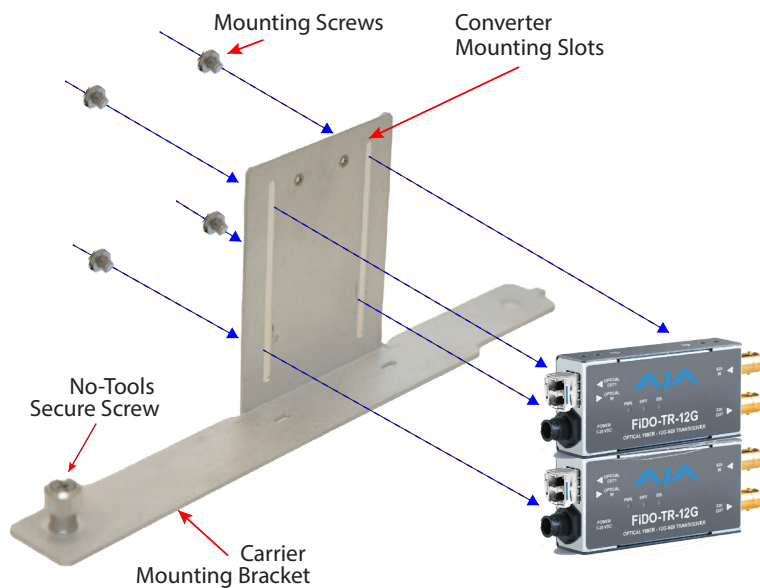

5. Install the Carrier with the two FiDOs into the DRM2 in the usual way.

NOTE: See *"Installing Carriers with Converters into the DRM2 Frame"* on page 11.

Depending on how many and what mix of converters you are installing into the frame, you may need to add a DC Power Y-Cable for the additional converters. These are simply added to any power connector on the main DC Power Harness.

Figure 26. AJA DC Power Y-Cable (optional)



Figure 27. Y-Cable added to DC Power Harness for stacked FiDO expansion



For installing the maximum of 24 FiDOs continue below.

6. Proceed to mount up to a total of 12 pairs of stacked FiDO Mini-Converters onto 12 Carriers.
7. Install the dual-FiDO Carriers into the DRM2 frame in the usual way.
8. Connect an AJA DC Power Y-Cable to all 12 of the DC connectors on the DRM2 main DC Power Harness. This will provide 24 DC power cables and connectors, supporting the maximum setup of 24 FiDOs.

Figure 28. Adding up to 12 Y-Cables to the main DC Power Harness

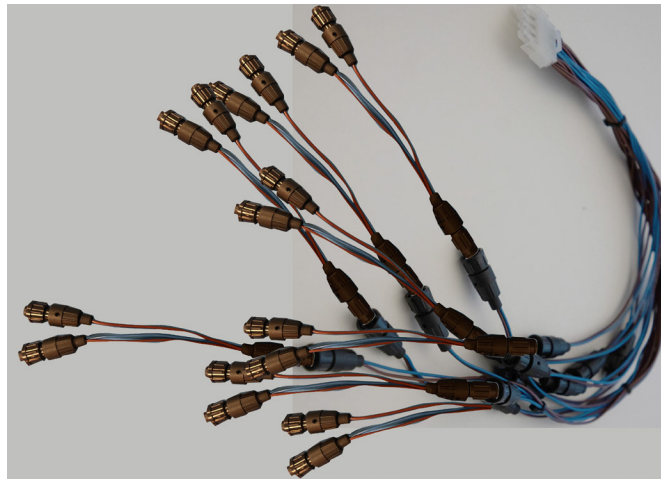

9. Connect the (up to) 24 Y-Cable power connectors to the (up to) 24 FiDO Mini-Converters.
10. Connect fiber and other remaining cables to the FiDO Mini-Converters as appropriate.

USB Connections

Below we describe use of USB hubs. USB may also be managed by KVM or KVM over IP, which are the beyond the scope of this manual.

USB Hub

There is no disadvantage to using a USB hub for Mini-Converters installed in a DRM2 frame, provided some good practices are employed:

- Use an actively-powered hub (one with an AC/DC adapter; not bus-powered).
- Use a high-quality hub, rated as compliant with USB v2.0 or higher.
- A USB v2.0 cable up to ten foot long may be used for the host computer connection.
- USB from the hub may also be extended by a suitable type of powered USB 2.0 (or higher) extender.

Figure 29. Example of a typical powered USB v2.0, 12-port hub

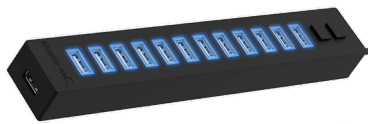

AJA Mini-Config USB Device Select

When using AJA Mini-Config software and a USB hub, all of a DRM2 frame's connected and powered Mini-Converters may be conveniently accessed from the device select menu:

Figure 30. Mini-Config device select menu for DRM2 frame with 12 devices

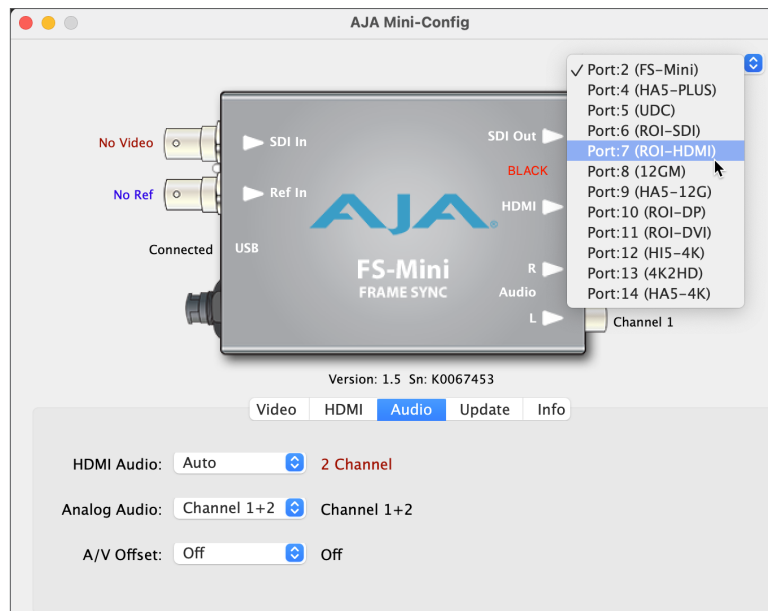

Appendix A – Specifications

DRM2 Tech Specs

User Interface

- 12x mounting slots for any AJA Mini-Converters
- Converters may be installed without removing the frame from the rack

Size (w x d x h)

- 19.0" x 15.0" x 5.25" (48.26 x 38.1cm x 13.34 cm)

Weight

- DRM2 w/12 Carriers, hardware, power harness, and power cord: 9.3 lbs (4.2 kg)
- DRM2 Faceplate w/o fans .9 lbs (.4 kg)
- DRM2 Faceplate w fans 2.1 lbs (.9 kg)

Power

- Universal 100-240V, 50/60Hz power input
- 12x +5V DC regulated outputs (hardwired to power supply)
- Power Consumption: 200 Watts maximum

NOTE: the total power required by all the installed AJA Mini-Converters must be less than the DRM2 frame maximum of 200 Watts. Refer to the individual AJA Mini-Converter Tech Specs Power section, available on the AJA website, to calculate the total power for the DRM2 converter configuration.

Environment

- Operating Temperature: 0 to 40 C (32 to 104 F)
- Safe Storage Temperature (Power Off): -40 to 60 C (-40 to 140 F)
- Operating Relative Humidity: 10-90% non-condensing
- Operating Altitude: <2,500 meters (<8,000 feet)

Appendix B – Safety and Compliance

Federal Communications Commission (FCC) Compliance Notices

Class A Interference Statement

This equipment has been tested and found to comply with the limits for a Class A digital device, pursuant to Part 15, Subpart B of the FCC Rules. These limits are designed to provide reasonable protection against harmful interference in a residential installation. This equipment generates, uses, and can radiate radio frequency energy and, if not installed and used in accordance with the instructions, may cause harmful interference to radio communications. However, there is no guarantee that interference will not occur in a particular installation. If this equipment does cause harmful interference to radio or television reception, which can be determined by turning the equipment off and on, the user is encouraged to try to correct the interference by one or more of the following measures:

- Reorient or relocate the receiving antenna.
- Increase the separation between the equipment and receiver.
- Connect the equipment into an outlet on a circuit different from that to which the receiver is connected.
- Consult the dealer or an experienced radio/TV technician for help.

FCC Caution

This device complies with Part 15 of the FCC Rules. Operation is subject to the following two conditions: (1) This device may not cause harmful interference, and (2) this device must accept any interference received, including interference that may cause undesired operation.

Canadian ICES Statement

Canadian Department of Communications Radio Interference Regulations

This digital apparatus does not exceed the Class A limits for radio-noise emissions from a digital apparatus as set out in the Radio Interference Regulations of the Canadian Department of Communications. This Class A digital apparatus complies with Canadian ICES-003.

Règlement sur le brouillage radioélectrique du ministère des Communications

Cet appareil numérique respecte les limites de bruits radioélectriques visant les appareils numériques de classe A prescrites dans le Règlement sur le brouillage radioélectrique du ministère des Communications du Canada. Cet appareil numérique de la Classe A est conforme à la norme NMB-003 du Canada.

European Union, European Free Trade Association (EFTA) and United Kingdom Regulatory Compliance

This equipment may be operated in the countries that comprise the member countries of the European Union, European Free Trade Association and the United Kingdom. These countries, listed in the following paragraph, are referred to as The European Community throughout this document:

AUSTRIA, BELGIUM, BULGARIA, CROATIA, CZECH REPUBLIC, DENMARK, ESTONIA, FINLAND, FRANCE, GERMANY, GREECE, HUNGARY, ICELAND, IRELAND, ITALY, LATVIA, LIECHTENSTEIN, LITHUANIA, LUXEMBOURG, MALTA, NETHERLANDS, NORWAY, POLAND, PORTUGAL, REPUBLIC OF CYPRUS, ROMANIA, SLOVAK REPUBLIC, SLOVENIA, SPAIN, SWEDEN, SWITZERLAND, UNITED KINGDOM

Declaration of Conformity

Marking by these symbols indicates compliance with the Essential Requirements of the EMC Directive of the European Union 2014/30/EU.



This equipment meets the following conformance standards:

Safety

EN 62368-1: 2014 + A11 (T-Mark License),
IEC 62368-1: 2014 (CB Scheme Report/Certificates)

Emissions

EN 55032: 2015 + A11: 2020, CISPR 32: 2015,
EN 61000-3-2: 2014, EN 61000-3-3: 2013

Immunity

EN 55035: 2017 + A11: 2020, EN 61000-4-2:2009,
EN 61000-4-3:2006+A1:2008 +A2:2010,
EN 61000-4-4: 2012, EN 61000-4-5: 2014 +A1: 2017, EN 61000-4-6: 2014,
EN 61000-4-11: 2020

Environments: E2, E3 and E4

The product is also licensed for additional country specific standards as required for the International Marketplace.



Warning! This is a Class A product. In a domestic environment, this product may cause radio interference, in which case, the user may be required to take appropriate measures.

Achtung! Dieses ist ein Gerät der Funkstörgrenzwertklasse A. In Wohnbereichen können bei Betrieb dieses Gerätes Rundfunkstörungen auftreten, in welchen Fällen der Benutzer für entsprechende Gegenmaßnahmen verantwortlich ist.

Attention! Ceci est un produit de Classe A. Dans un environnement domestique, ce produit risque de créer des interférences radioélectriques, il appartiendra alors à l'utilisateur de prendre les mesures spécifiques appropriées.

Recycling Notice



This symbol on the product or its packaging indicates that this product must not be disposed of with your other household waste. Instead, it is your responsibility to dispose of your waste equipment by handing it over to a designated collection point for the recycling of waste electrical and electronic equipment. The separate collection and recycling of your waste equipment at the time of disposal will help conserve natural resources and ensure that it is recycled in a manner that protects human health and the environment. For more information about where you can drop off your waste for recycling, please contact your local authority, or where you purchased your product.

Korea KCC Compliance Statement

사용자 안내문

이 기기는 업무용 환경에서 사용할 목적으로 적합성평가를 받은 기기로서 가정용 환경에서 사용하는 경우 전파간섭의 우려가 있습니다.

Taiwan Compliance Statement

警告使用者：
這是甲類的資訊產品，在居住的環境中使用時，可能會造成射頻干擾，在這種情況下，使用者會被要求採取某些適當的對策。

This is a Class A product based on the standard of the Bureau of Standards, Metrology and Inspection (BSMI) CNS 13438, Class A. In a domestic environment this product may cause radio interference in which case the user may be required to take adequate measures.

Japan Compliance Statement

この装置は、クラスA情報技術装置です。この装置を家庭環境で使用すると電波妨害を引き起こすことがあります。この場合には使用者が適切な対策を講ずるよう要求されることがあります。 VCCI-A

This is a Class A product based on the standard of the VCCI Council (VCCI 32: 2016). If this equipment is used in a domestic environment, radio interference may occur, in which case, the user may be required to take corrective actions.

Translated Warning and Caution Messages

The following caution statements, warning conventions, and warning messages apply to this product and manual.



Warning Symbol



Hazard Symbol



Caution Symbol

Before Operation Please Read These Instructions



Warning! Read and follow all warning notices and instructions marked on the product or included in the documentation.

Avertissement! Lisez et conformez-vous à tous les avis et instructions d'avertissement indiqués sur le produit ou dans la documentation.

Warnung! Lesen und befolgen Sie die Warnhinweise und Anweisungen, die auf dem Produkt angebracht oder in der Dokumentation enthalten sind.

¡Advertencia! Lea y siga todas las instrucciones y advertencias marcadas en el producto o incluidas en la documentación.

Aviso! Leia e siga todos os avisos e instruções assinalados no produto ou incluídos na documentação.

Avviso! Leggere e seguire tutti gli avvisi e le istruzioni presenti sul prodotto o inclusi nella documentazione.



Warning! Do not use this device near water and clean only with a dry cloth.

Avertissement! N'utilisez pas cet appareil près de l'eau et nettoyez-le seulement avec un tissu sec.

Warnung! Das Gerät nicht in der Nähe von Wasser verwenden und nur mit einem trockenen Tuch säubern.

¡Advertencia! No utilice este dispositivo cerca del agua y límpielo solamente con un paño seco.

Aviso! Não utilize este dispositivo perto da água e limpe-o somente com um pano seco.

Avviso! Non utilizzare questo dispositivo vicino all'acqua e pulirlo soltanto con un panno asciutto.



Warning! Do not block any ventilation openings. Install in accordance with the manufacturer's instructions.

Avertissement! Ne bloquez aucune ouverture de ventilation. Suivez les instructions du fabricant lors de l'installation.

Warnung! Die Lüftungsöffnungen dürfen nicht blockiert werden. Nur gemäß den Anweisungen des Herstellers installieren.

¡Advertencia! No bloquee ninguna de las aberturas de la ventilación. Instale de acuerdo con las instrucciones del fabricante.

Aviso! Não obstrua nenhuma das aberturas de ventilação. Instale de acordo com as instruções do fabricante.

Avviso! Non ostruire le aperture di ventilazione. Installare in conformità con le istruzioni del fornitore.



Warning! Do not install near any heat sources such as radiators, heat registers, stoves, or other apparatus (including amplifiers) that produce heat.

Avertissement! N'installez pas l'appareil près d'une source de chaleur telle que des radiateurs, des bouches d'air de chauffage, des fourneaux ou d'autres appareils (amplificateurs compris) qui produisent de la chaleur.

Warnung! Nicht in der Nähe von Wärmequellen wie Heizkörpern, Heizregistern, Öfen oder anderen Wärme erzeugenden Geräten (einschließlich Verstärkern) aufstellen.

¡Advertencia! No instale cerca de fuentes de calor tales como radiadores, registros de calor, estufas u otros aparatos (incluidos amplificadores) que generan calor.

Aviso! Não instale perto de nenhuma fonte de calor tal como radiadores, saídas de calor, fogões ou outros aparelhos (incluindo amplificadores) que produzam calor.

Avviso! Non installare vicino a fonti di calore come termosifoni, diffusori di aria calda, stufe o altri apparecchi (amplificatori compresi) che emettono calore.



Warning! Do not defeat the safety purpose of the polarized or grounding-type plug. A polarized plug has two blades with one wider than the other. A grounding type plug has two blades and a third grounding prong. The wide blade or the third prong are provided for your safety. If the provided plug does not fit into your outlet, consult an electrician for replacement of the obsolete outlet.

Avertissement! La sécurité de la prise polarisée ou de la prise de type mise à la terre ne doit en aucun cas être empêchée de fonctionner. Une prise polarisée a deux broches, l'une étant plus large que l'autre. Une prise de type mise à la terre a deux broches et une troisième broche pour la mise à la terre. La broche large ou la troisième broche sont fournies pour votre sécurité. Si la prise fournie ne s'insère pas dans votre prise femelle, consultez un électricien pour le remplacement de la prise femelle obsolète.

Warnung! Der Sicherheitszweck des gepolten bzw. Schukosteckers ist zu berücksichtigen. Ein gepolter Stecker verfügt über zwei Pole, von denen einer breiter als der andere ist. Ein Schukostecker verfügt neben den zwei Polen noch über einen dritten Pol zur Erdung. Der breite Pol bzw. der Erdungspol dienen der Sicherheit. Wenn der zur Verfügung gestellte Stecker nicht in Ihren Anschluss passt, konsultieren Sie einen Elektriker, um den veralteten Anschluss zu ersetzen.

¡Advertencia! No eche por tierra la finalidad del tipo de enchufe polarizado con conexión a tierra. Un enchufe polarizado tiene dos espigas, una más ancha que la otra. Un enchufe con conexión a tierra tiene dos espigas iguales y una tercera espiga que sirve para la conexión a tierra. La espiga ancha, o la tercera espiga, sirven para su seguridad. Si el enchufe suministrado no encaja en el tomacorriente, consulte con un electricista para reemplazar el tomacorriente obsoleto.

Aviso! Não anule a finalidade da segurança da ficha polarizada ou do tipo ligação terra. Uma ficha polarizada tem duas lâminas sendo uma mais larga do que a outra. Uma ficha do tipo de ligação à terra tem duas lâminas e um terceiro terminal de ligação à terra. A lâmina larga ou o terceiro terminal são fornecidos para sua segurança. Se a ficha fornecida não couber na sua tomada, consulte um electricista para a substituição da tomada obsoleta.

Avviso! Non compromettere la sicurezza della spina polarizzata o con messa a terra. Una spina polarizzata ha due spinotti, di cui uno più largo. Una spina con messa a terra ha due spinotti e un terzo polo per la messa a terra. Lo spinotto largo o il terzo polo sono forniti per motivi di sicurezza. Se la spina fornita non si inserisce nella presa di corrente, contattare un elettricista per la sostituzione della presa obsoleta.



Warning! Since the Mains plug is used as the disconnection for the device, it must remain readily accessible and operable.

Avertissement! Puisque la prise principale est utilisée pour débrancher l'appareil, elle doit rester aisément accessible et fonctionnelle.

Warnung! Da der Netzstecker als Trennvorrichtung dient, muss er stets zugänglich und funktionsfähig sein.

¡Advertencia! Puesto que el enchufe de la red eléctrica se utiliza como dispositivo de desconexión, debe seguir siendo fácilmente accesible y operable.

Aviso! Dado que a ficha principal é utilizada como a desconexão para o dispositivo, esta deve manter-se prontamente acessível e funcional.

Avviso! Poiché il cavo di alimentazione viene usato come dispositivo di sconnessione, deve rimanere prontamente accessibile e operabile.



Warning! Protect the power cord from being walked on or pinched particularly at plugs, convenience receptacles, and the point where they exit from the device.

Avertissement! Protégez le cordon d'alimentation pour que l'on ne marche pas dessus ou qu'on le pince, en particulier au niveau des prises mâles, des réceptacles de convenance, et à l'endroit où il sort de l'appareil.

Warnung! Vermeiden Sie, dass auf das Netzkabel getreten oder das Kabel geknickt wird, insbesondere an den Steckern, den Steckdosen und am Kabelausgang am Gerät.

¡Advertencia! Proteja el cable de energía para que no se le pise ni apriete, en especial cerca del enchufe, los receptáculos de conveniencia y el punto del que salen del equipo.

Aviso! Proteja o cabo de alimentação de ser pisado ou de ser comprimido particularmente nas fichas, em tomadas de parede de conveniência e no ponto de onde sai do dispositivo.

Avviso! Proteggere il cavo di alimentazione in modo che nessuno ci cammini sopra e che non venga schiacciato soprattutto in corrispondenza delle spine e del punto in cui esce dal dispositivo.



Warning! Unplug this device during lightning storms or when unused for long periods of time.

Avertissement! Débranchez cet appareil pendant les orages avec éclairs ou s'il est inutilisé pendant de longues périodes.

Warnung! Das Gerät ist bei Gewitterstürmen oder wenn es über lange Zeiträume ungenutzt bleibt vom Netz zu trennen.

¡Advertencia! Desenchufe este dispositivo durante tormentas eléctricas o cuando no se lo utilice por largos periodos del tiempo.

Aviso! Desconecte este dispositivo da tomada durante trovoadas ou quando não é utilizado durante longos períodos de tempo.

Avviso! Utilizzare soltanto i collegamenti e gli accessori specificati e/o venduti dal produttore, quali il treppiedi e l'esoscheletro.



Warning! Refer all servicing to qualified service personnel. Servicing is required when the device has been damaged in any way, such as power-supply cord or plug is damaged, liquid has been spilled or objects have fallen into the device, the device has been exposed to rain or moisture, does not operate normally, or has been dropped.

Avertissement! Référez-vous au personnel de service qualifié pour tout entretien. L'entretien est exigé quand l'appareil a été endommagé de quelque manière que ce soit, par exemple lorsque le cordon d'alimentation ou la prise sont endommagés, que du liquide a été versé ou des objets sont tombés dans l'appareil, que l'appareil a été exposé à la pluie ou à l'humidité, ne fonctionne pas normalement ou est tombé.

Warnung! Das Gerät sollte nur von qualifizierten Fachkräften gewartet werden. Eine Wartung ist fällig, wenn das Gerät in irgendeiner Weise beschädigt wurde, wie bei beschädigtem Netzkabel oder Netzstecker, falls Flüssigkeiten oder Objekte in das Gerät gelangen, das Gerät Regen oder Feuchtigkeit ausgesetzt wurde, nicht ordnungsgemäß funktioniert oder fallen gelassen wurde.

¡Advertencia! Consulte al personal calificado por cuestiones de reparación. El servicio de reparación se requiere cuando el dispositivo ha recibido cualquier tipo de daño, por ejemplo cable o espigas dañadas, se ha derramado líquido o se han caído objetos dentro del dispositivo, el dispositivo ha sido expuesto a la lluvia o humedad, o no funciona de modo normal, o se ha caído.

Aviso! Remeta todos os serviços de manutenção para o pessoal de assistência qualificado. A prestação de serviços de manutenção é exigida quando o dispositivo foi danificado mediante qualquer forma, como um cabo de alimentação ou ficha que se encontra danificado/a, quando foi derramado líquido ou caíram objectos sobre o dispositivo, quando o dispositivo foi exposto à chuva ou à humidade, quando não funciona normalmente ou quando foi deixado cair.

Avviso! Fare riferimento al personale qualificato per tutti gli interventi di assistenza. L'assistenza è necessaria quando il dispositivo è stato danneggiato in qualche modo, ad esempio se il cavo di alimentazione o la spina sono danneggiati, è stato rovesciato del liquido è stato rovesciato o qualche oggetto è caduto nel dispositivo, il dispositivo è stato esposto a pioggia o umidità, non funziona correttamente o è caduto.



Warning! Disconnect the external AC power supply line cord(s) from the mains power before moving the unit.

Avertissement! Retirez le ou les cordons d'alimentation en CA de la source d'alimentation principale lorsque vous déplacez l'appareil.

Warnung! Trennen Sie die Wechselstrom-Versorgungskabel vom Netzstrom, bevor Sie das Gerät verschieben.

¡Advertencia! Cuando mueva la unidad desenchufe de la red eléctrica el/los cable(s) de la fuente de alimentación CA tipo brick.

Advertência! Remova os cabos CA de alimentação brick da rede elétrica ao mover a unidade.

Avvertenza! Scollegare il cavo dell'alimentatore quando si sposta l'unità.



Warning! Only use attachments and accessories specified and/or sold by the manufacturer.

Avertissement! Utilisez seulement les attaches et accessoires spécifiés et/ou vendus par le fabricant.

Warnung! Verwenden Sie nur Zusatzgeräte und Zubehör angegeben und / oder verkauft wurde durch den Hersteller.

¡Advertencia! Utilice solamente los accesorios y conexiones especificados y/o vendidos por el fabricante.

Aviso! Utilize apenas equipamentos/acessórios especificados e/ou vendidos pelo fabricante.

Avviso! Utilizzare soltanto i collegamenti e gli accessori specificati e/o venduti dal produttore.



Hazard! High Voltage. This situation or condition can cause injury due to electric shock.

Avertissement! Tension élevée. Cette situation ou condition peut causer des blessures dues à un choc électrique.

Warnung! Hochspannung. Diese Situation oder Bedingung kann zu Verletzungen durch Stromschlag führen.

¡Advertencia! Alto voltaje . Esta situación o condición puede causar lesiones debidas a una descarga eléctrica.

Aviso! Alta Tensão . Esta situação ou condição pode causar danos devido a choques elétricos.

Avviso! Alta tensione. Questa situazione o condizione può causare lesioni a causa di scosse elettriche.

Warranty and Liability Information

Limited Warranty

AJA Video Systems, Inc. (AJA Video) warrants that this product will be free from defects in materials and workmanship for a period of five years from the date of purchase. If a product proves to be defective during this warranty period, AJA Video, at its option, will either repair the defective product without charge for parts and labor, or will provide a replacement in exchange for the defective product.

In order to obtain service under this warranty, you the Customer, must notify AJA Video of the defect before the expiration of the warranty period and make suitable arrangements for the performance of service. The Customer shall be responsible for packaging and shipping the defective product to a designated service center nominated by AJA Video, with shipping charges prepaid. AJA Video shall pay for the return of the product to the Customer if the shipment is to a location within the country in which the AJA Video service center is located. Customer shall be responsible for paying all shipping charges, insurance, duties, taxes, and any other charges for products returned to any other locations.

This warranty shall not apply to any defect, failure or damage caused by improper use or improper or inadequate maintenance and care. AJA Video shall not be obligated to furnish service under this warranty a) to repair damage resulting from attempts by personnel other than AJA Video representatives to install, repair or service the product, b) to repair damage resulting from improper use or connection to incompatible equipment, c) to repair any damage or malfunction caused by the use of non-AJA Video parts or supplies, or d) to service a product that has been modified or integrated with other products when the effect of such a modification or integration increases the time or difficulty of servicing the product.

THIS WARRANTY IS GIVEN BY AJA VIDEO IN LIEU OF ANY OTHER WARRANTIES, EXPRESS OR IMPLIED. AJA VIDEO AND ITS VENDORS DISCLAIM ANY IMPLIED WARRANTIES OF MERCHANTABILITY OR FITNESS FOR A PARTICULAR PURPOSE. AJA VIDEO'S RESPONSIBILITY TO REPAIR OR REPLACE DEFECTIVE PRODUCTS IS THE WHOLE AND EXCLUSIVE REMEDY PROVIDED TO THE CUSTOMER FOR ANY INDIRECT, SPECIAL, INCIDENTAL OR CONSEQUENTIAL DAMAGES IRRESPECTIVE OF WHETHER AJA VIDEO OR THE VENDOR HAS ADVANCE NOTICE OF THE POSSIBILITY OF SUCH DAMAGES.

Index

A

- Active Faceplate 5
- AJA Mini-Config 19
- AJA Support 2
- Attach an Active Faceplate 13
- Attach an Passive Faceplate 12

B

- Basic Order 7

C

- Configure Carrier Bracket(s) 11
- Converters into the DRM2 Frame 11

D

- Dimensions 20

E

- Environment 20

F

- Features 5
- Front Faceplates 5

H

- High Capacity 4

I

- Included in the box
- Installation 7, 9
- Install Carriers into the DRM2 Frame 11
- Installing Carriers with Converters 11
- Installing Converters into the DRM2 Frame 11

M

- Mini-Converter Carriers 8
- Mini-Converter Frame for 19-inch Racks 4
- Mini-Converter Mounting Carriers 8
- Mini-Converter Mounting Hardware 8
- Mounting 24 FIDO Converters 16
- Mounting Converters onto Carriers 9
- Mounting Converters with DIP Switches 16
- Mounting Mini-Converters using bottom holes 10
- Mounting Mini-Converters using rear holes 10

O

- Overview 4
- Overview of Installation 8

P

- Parts Available Separately 7
- Passive Faceplate 5
- Power 20

R

- Rack Mount Frame 8
- Rack Mount Frame with Carrier Slots 8
- Remove Active Faceplate 14
- Remove Bottom-Mounted Converter from Carrier 16
- Remove Carrier from DRM2 Frame 15
- Remove Passive Faceplate 14
- Remove Rear-Mounted Converter from Carrier 15
- Replace the front faceplate 13

S

- Safety and Compliance 21
- Separately Available Parts
- Special Case Installations 16
- Specifications 20
- Stacking FiDO Converters Two-high on Carriers 16

T

- Twelve Mini-Converters Example Configuration 9

U

- USB Connections 19
- USB Device Select 19
- USB Hub 19

W

- Warranty and Liability 29