

Io 4K/XT

Capture, Display, Convert



Installation and Operation Manual

Version 15.2
Published June 3, 2019



Notices

Trademarks

AJA® and Because it matters.® are registered trademarks of AJA Video Systems, Inc. for use with most AJA products. AJA™ is a trademark of AJA Video Systems, Inc. for use with recorder, router, software and camera products. Because it matters.™ is a trademark of AJA Video Systems, Inc. for use with camera products.

CION®, Corvid Ultra®, Io®, Ki Pro®, KONA®, KUMO®, ROI® and T-Tap® are registered trademarks of AJA Video Systems, Inc.

AJA Control Room™, KiStor™, Science of the Beautiful™, TruScale™, TruZoom™, V2Analog™ and V2Digital™ are trademarks of AJA Video Systems, Inc.

All other trademarks are the property of their respective owners.

Copyright

Copyright © 2019 AJA Video Systems, Inc. All rights reserved. All information in this manual is subject to change without notice. No part of the document may be reproduced or transmitted in any form, or by any means, electronic or mechanical, including photocopying or recording, without the express written permission of AJA Video Systems, Inc.

Contacting AJA Support

When calling for support, have all information at hand prior to calling. To contact AJA for sales or support, use any of the following methods:

Telephone	+1.530.271.3190
FAX	+1.530.271.3140
Web	https://www.aja.com
Support Email	support@aja.com
Sales Email	sales@aja.com

Contents

Notices	2
Trademarks	2
Copyright	2
Contacting AJA Support	2
Chapter 1 – Introduction	5
Overview	5
Features	5
Broadcast-Quality Conversion	6
Io 4K/XT Audio	6
AJA Software & Utilities	7
System Requirements	8
What's In The Box?	8
In This Manual	9
Chapter 2 – Installation	10
Installation Overview	10
AJA System Test Application	10
Connecting To Your Computer	10
Cable Connections	11
Connector Descriptions	11
Installing Io 4K/XT Software	13
Download	13
Software Package Installation and Re-installation	14
Firmware Update Procedure	14
Chapter 3 – Io 4K/XT Operation	16
Front Panel Operation	16
Monitor Output and Gain Control	16
Audio Level Meters	17
Power Switch (Io XT)	17
Power LED (Io 4K)	17
AJA Control Panel Overview	17
AJA Control Panel User Interface	18
Controlling Application	20
Presets	20
Single-User & Shared Preferences	21
Function Screens	22
Using Io XT and Io 4K for HD, SD, 2K	22
Control Screen	23
Format Screen	25
Input Select Screen	27
SDI Output Screen	29
HDMI Screen	30
Analog Out Screen (Io XT Only)	32
Video Setup Screen	33
Audio Setup Screen	34
DS Keyer Screen	35
LUT Screen	37
Timecode Screen	40
Presets Screen	41
Firmware Screen	42
Info Screen	43
Using Io 4K for UltraHD/4K	43
4K/UltraHD Transport Modes	43
Io 4K in 4K Mode Audio Monitoring	45
Io 4K Control Panel Screen Differences in 4K Mode	46
Io 4K Control Screen in 4K Mode	46
Io 4K Format Screen in 4K Mode	48

lo 4K Input Select Screen in 4K Mode	49
lo 4K SDI Output Screen in 4K Mode	50
lo 4K HDMI Screen in 4K Mode	51
lo 4K HDMI HDR Screen in 4K Mode	52
lo 4K Video Setup Screen in 4K Mode	54
lo 4K Audio Mixer Screens (4K Mode only)	55
Playback Monitor Mode (4K Mode only)	56
lo 4K Downstream Keyer in 4K Mode	57
Appendix A – Specifications	58
lo 4K Tech Specs	58
lo XT Tech Specs	60
Audio Connection Pinouts.	63
Appendix B – Safety and Compliance	64
Warranty and Liability Information	72
Limited Warranty on Hardware.	72
Limitation of Liability	73
Governing Law and Language; Your Rights.	73
Index.	74

Chapter 1 – Introduction



Overview

AJA's io XT and io 4K provide professional-grade I/O for high-end computers, and each is an ideal companion for lightning-fast video capture, playback and up/down/cross conversion. Designed for today's workflows, io 4K/XT provides an ideal interface for video professionals to bridge the gap between their Thunderbolt-enabled computers, and other pro video devices.

io 4K/XT connects with a single Thunderbolt cable and provides a second Thunderbolt connector for storage, making them perfect for on set, or in the edit suite. io 4K/XT's 10-bit hardware conversion capability paired with a Thunderbolt storage system creates a super-fast editing system, portable enough to fit in a backpack—with desktop level power.

Features

Table 1. io 4K/XT Feature Comparison

Feature	io XT	io 4K
Two Thunderbolt 2 ports		✓
Two Thunderbolt 1 ports	✓	
Two SD-SDI, HD-SDI, and 3G HD-SDI inputs and outputs	✓	✓
Dedicated realtime 4K to HD down-conversion output (SDI 5 BNC)		✓
Supports both Quadrant and Two Sample Interleave transport of UltraHD and 4K video		4K Mode
HDR Features (HDR10 or HLG via HDMI, 12 Bit RGB, BT2020))		✓
Single link SDI 4:2:2 or 4:4:4; Dual-link SDI 4:4:4	✓	✓
Bidirectional SDI BNCs configurable for four 4K inputs or outputs		4K Mode
HDMI Input and Output	✓	✓
Analog component/composite output, 10-bit	✓	
Broadcast quality hardware-based 10-bit up-conversion	✓	✓
Broadcast quality hardware-based 10-bit down-conversion	✓	✓

Feature	Io XT	Io 4K
Broadcast quality hardware-based 10-bit cross-conversion (1080 to 720 and 720 to 1080)	√	√
Dedicated realtime 4K to HD down-conversion output (SDI 5 BNC)		√
DVCProHD hardware scaling acceleration	√	√
HDV hardware scaling acceleration	√	√
Broadcast quality hardware-based 10-bit SD aspect ratio conversion (anamorphic to letterbox, etc.)	√	√
16-Channel Embedded SDI audio	√	√
Eight channels analog audio output (Tascam-style DB25-type cable)	√	√
Audio Monitoring Mixer, including Host Computer and Application		4K Mode
Front panel LED VU meters and Headphone output w/level control	√	√
Reference In/LTC In (selectable)	√	√
LTC Output	√	√
RS-422 control via 9-pin	√	√
Rugged Chassis, Small Size	√	√
12V DC, 4-pin XLR Power (AC adapter included)	√	√

Broadcast-Quality Conversion

Io 4K/XT features hardware-based full 10-bit broadcast quality motion adaptive SD to HD up-conversion, HD to SD down-conversion and HD to HD cross-conversion.

The quality of the conversion features is virtually identical to AJA's award winning stand-alone converter products used throughout the post production market. The Io 4K/XT's built-in up converter uses a full 10-bit path, fully motion adaptive de-interlacing, and large multi-point digital interpolators. Down-conversion uses large multi-point digital interpolators, anti-alias filtering and interpolation.

Cross-conversion is high-quality hardware-based and offers true broadcast picture quality in realtime. Because these functions are in hardware, they are available full time, all the time—with no CPU load. Such conversions are useful for cost effective monitoring, making standard definition dubs of an HD project, or up-converting from a standard definition project to an HD deliverable.

Video Formats

For a list of supported video formats, see ["Appendix A Specifications" on page 58](#).

Io 4K/XT Audio

Io 4K/XT provides up to 16 channels of SDI embedded audio. The front panels have a mini TRS headphone output with a lockable level control knob.

Io 4K/XT also supports HDMI Audio, 2 or 8 channels.

For analog audio output monitoring, Io 4K/XT provides a DB25 connector with eight channels of audio to be used with industry standard Tascam-style audio breakout cables. The front panel has an eight-channel VU meter display to monitor output levels.

Io 4K, when in 4K Mode, also supports monitoring mixed audio from Io 4K inputs, host computer, and controlling application.

AJA Software & Utilities

AJA's Io 4K/XT software and hardware were developed for powerful integrated video/audio capture, editing, and production with a variety of 3rd-party software. With Io 4K/XT and a qualified computer, you have the ultimate system for production, post-production, broadcast, and streaming work. AJA software is distributed as a unified package which includes all the software, firmware, plugins, and utility programs for AJA's Io, KONA, and T-TAP products.

Two retail packages are available, one for Mac and one for Windows.

Mac and Windows Packages

These packages include:

Firmware

Firmware, otherwise referred to as a bit file or the card's 'personality', refers to very low level code that defines the capabilities of the hardware. It is important to always update to the firmware recommended following install of new, or older versions of software.

Drivers

AJA device drivers for the host system OS provide tightly integrated hardware/software operation.

AJA Control Panel

The Control Panel provides:

- Source selection and control of your AJA hardware.
- A block diagram to show visually what routing and processing is being performed.

AJA Control Room

Control Room is a cross-platform software application for ingest, playback and output with AJA products.

AJA System Test

AJA System Test provides accurate and detailed evaluations of drive and system performance statistics, allowing you to measure the capabilities of your system for recording and playing back various resolutions and codecs. The application includes:

- System Disk Test
- AJA Device Test
- Disk + Device Test
- System Report

The application tests Read and Write, Capture and Playback speeds in both Megabytes per second and Frames per second. The disk speed tests differ from standard disk I/O performance applications in that they specifically test the system under conditions typically encountered with video capture, playback, and editing.

NOTE: Theoretically the best test (or simulation) is to fill your storage disk to 80% and then test capture at the highest data rate you will use.

Plug-ins for popular 3rd-party Professional Video Applications from Adobe, Avid, Apple, Telestream, and others.

System Requirements

AJA Video recommends that your system meet minimum hardware and software requirements to achieve a satisfactory level of performance. Updates to system requirements are subject to change.

NOTE: See Software Vendor system requirements for GPU recommendations and additional hardware requirements and recommendations.

AJA recommends:

- MacOS 10.12 Sierra or later
- Win 10 or later with all updates
- 2.5 GHz quad core i7 minimum, for HD
- 3.5 GHz eight core minimum, faster processors and more cores recommended, for UHD/4K workflows, especially with high frame rate*
- 16GB RAM minimum, 32GB or more recommended, especially for UHD/4K or High Frame Rate applications
- A reasonably fast and powerful graphics card, with plenty of on-board memory. Examples (may be specific to application version and/or host CPU) include:
 - Nvidia K5200
 - Nvidia K4200
 - Nvidia M6000
 - Nvidia M5000
 - Nvidia M4000
 - AMD W7100
 - AMD W8100
- Media storage with adequate bandwidth to sustain the capture and playback of the material you expect to be working with.

NOTE: For large scale installations with shared storage, or for very high performance requirements, AJA recommends consultation with an experienced a system integrator. A consultant will be able to assist with many important variables.

What's In The Box?

As you unpack the shipping box(es), carefully examine the contents. Ensure you received everything and that nothing was damaged during shipment. If you find any damage, immediately notify the shipping service and supply them with a complete description of the damage. AJA will repair or replace damaged items. If you find shipping damage, contact your AJA dealer or distributor for details on how to have your Io 4K/XT repaired or replaced. Save packing materials and the shipping box. If you ever require service or move your system—use the packaging materials and box for safe shipment.

When you unpack your AJA Io 4K/XT, you'll find the following components:

- Io XT or Io 4K
- 12V power adapter and power cord

In This Manual

Chapter 1 - Introduces the product briefly, listing features, box contents, and system requirements.

Chapter 2 - Provides complete instructions for installing and configuring the AJA Io 4K/XT. The user is guided through unpacking, cabling the Io 4K/XT, installing AJA & third-party support software, then getting it up and running.

Chapter 3 - Discusses operational aspects of Io 4K/XT and how to work with 3rd-party software.

Appendix A - Presents a list of technical specifications for the product.

Appendix B - Provides important Safety and Compliance information.

Warranty and Index

Chapter 2 – Installation

Installation Overview

1. If not previously installed on your Thunderbolt equipped computer, ensure that appropriate application software is installed as detailed in its user documentation.
2. For latest System Compatibility and Software Version information visit the AJA website.
 - For Io XT, visit: <https://www.aja.com/en/products/io-xt/#/overview>
 - For Io 4K visit: <https://www.aja.com/en/products/io-4k#overview>
3. Install the latest AJA software on your computer from the AJA website.
 - For Io XT, visit: <https://www.aja.com/en/products/io-xt/#support>
 - For Io 4K visit: <https://www.aja.com/en/products/io-4k#support>

For further support information and downloads for third-party software and DirectShow for Developers, go to:

<https://www.aja.com/en/category/edit/compatibility>

AJA System Test Application

AJA System Test is a utility for measuring system performance with AJA Io devices. The application includes:

- System Disk Test
- AJA Device Test
- Disk + Device Test
- System Report

The application tests Read and Write, Capture and Playback speeds tests in both Megabytes per second and Frames per second. The disk speed tests differ from standard disk I/O performance applications in that they specifically test the system under conditions typically encountered with video capture, playback, and editing.

We suggest the best test is to fill your storage disk to 80% and then test capture at the highest data rate you will use.

Connecting To Your Computer

1. Connect a Thunderbolt cable between the computer and the Io 4K/XT.
2. Power the unit (AC supply or battery) and if it is Io XT, turn it on using the power button on the front. Io 4K does not have a power button.
3. Cable the system audio and video sources, VTR, audio monitor, and video monitor.
4. When you run the AJA Control Panel, you'll notice that the Io 4K/XT is auto-discovered as long as it is properly cabled and powered up.

Cable Connections

Figure 1. lo XT Rear Connectors

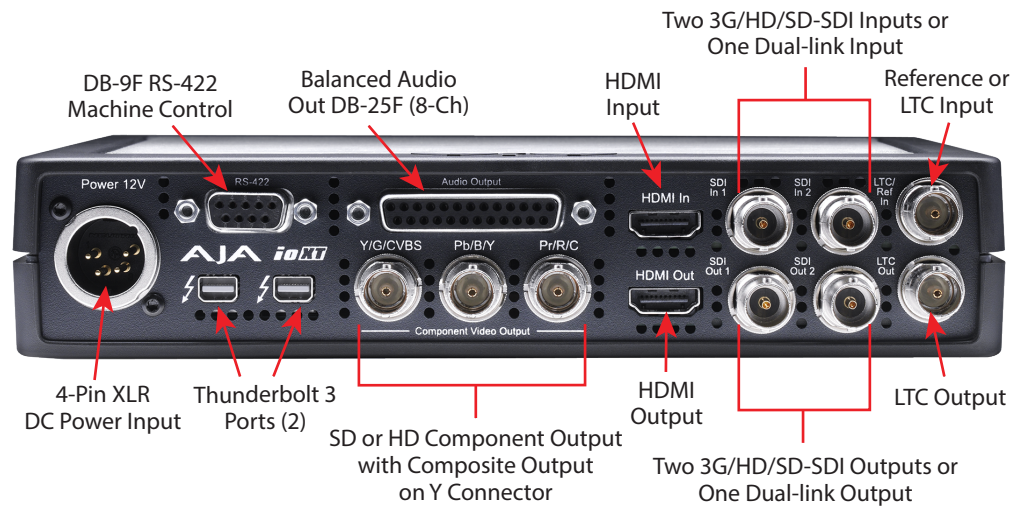
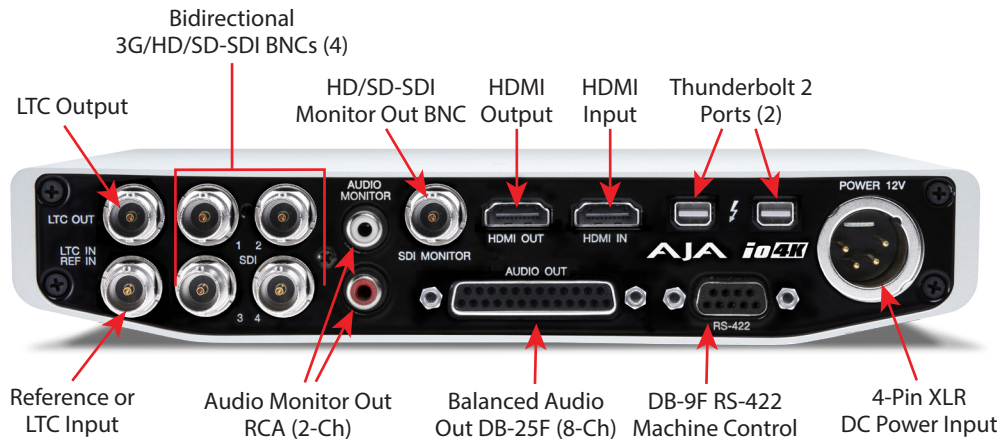

Figure 2. lo 4K Rear Connectors



Connector Descriptions

Connectors Common to Both Models

HDMI Input and Output

Two HDMI connectors on the lo 4K/XT provide input and output of HDMI video and multi-channel embedded audio.

- lo XT has HDMI v1.3 input capability at 30 bits per pixel that allows full support of the latest 10-bit monitors, and has HDMI v1.4 output capability.
- lo 4K has HDMI 1.4 input and output capability, supporting Ultra HD and 4K resolutions at up to 30 frames per second at 10 Bit 4:2:2 and 50/60 frames per second at 8-Bit 4:2:0. lo 4K also supports HDR (HDR10 and HLG) via the HDMI 1.4 output.
- Both lo XT and lo 4K support 2 or 8 channel HDMI audio input and output.

HDCP is not supported on either input or output. Io 4K/XT HDMI output does not have HDCP, and input sources having HDCP are not supported. The HDMI input is designed to support long cable runs—up to 100 ft. when using 22 or 24AWG HDMI cable, or up to 50 ft. using 28 or 30AWG HDMI cable. The HDMI output supports standard HDMI cables only.

RS-422 Machine Control

A female DE-9 connector on Io 4K/XT provides connection for VTRs, camcorders, disk media servers, and other devices using RS-422 SMPTE (Sony) protocol.

Reference Video and LTC Input

Two BNC connectors on Io 4K/XT provide reference Input and Output. The Reference Video input can also be used for LTC input. The selection of Reference (sync) or LTC is set using the AJA Control Panel ("[Input Select Screen](#)" on page 27).

In Video Pass-through mode, these connectors are effectively loop-through. Supplying reference signal to the Reference input allows you to synchronize Io 4K/XT outputs to your house analog reference video signal (or black burst). If you have a sync generator or central piece of video equipment to use for synchronizing other video equipment in your studio, then connect its analog composite output here. When Io 4K/XT outputs video, it uses this reference signal for locking. When connecting a reference video source, the locking signal should be the same format as the Primary format selected in the AJA Control Panel. It is possible in some circumstances to use an alternate format video signal as long as the basic frame rate is compatible.

Balanced Analog Audio Output

A 25-pin DB connector provides 8-channel, 24-bit D/A analog audio, 48kHz sample rate, balanced via 8x XLR on DB-25 breakout cable. (Cable not supplied.)

12V Power Connector

A standard 4-pin XLR type connector is provided for either battery or line source power using the supplied AC power adapter.

Io XT Connectors

These connectors are used only on the Io XT model.

Thunderbolt Ports

The Io XT provides first-generation Thunderbolt ports. Two ports are provided for "daisy-chained" network configurations.

See <https://www.aja.com/solutions/thunderbolt> for more information about Thunderbolt.

HD/SD SDI Input and Output

BNC connectors are provided on Io XT for two HD/SD-SDI inputs and two HD/SD-SDI outputs. The input and output support video and embedded 24-bit digital audio. Use SDI wherever possible for the best quality 10-bit uncompressed video input, capture and output. If peripheral equipment has a variety of inputs/outputs, look to see if it has SDI I/O, and use it where possible. Most high-end professional broadcast equipment supports SDI (VTRs, cameras, media storage servers, etc.).

Component Video Output

Io XT features a group of 3 BNC connectors for output of component, composite and Y/C functions. The signals are labeled on the BNC connectors on the rear panel of Io XT.

NOTE: *Component Video, or YPbPr, has been given several names over time. YUV, Y/R-Y/B-Y, and YCbCr, are just some examples. Although these various formats have some differences in levels, they are all basically the same. Io XT uses the modern YPbPr terminology exclusively. Io XT supports three different types of YPbPr: SMPTE/EBU N10, Betacam (NTSC), and Betacam (NTSC Japan). These three formats differ in level only and are configured via the AJA Control Panel.*

Io 4K Connectors

These connectors are offered only on the Io 4K model.

Thunderbolt 2 Ports

The Io 4K provides the second-generation Thunderbolt ports to support UltraHD and 4K signals. Two ports are provided for “daisy-chained” network configurations.

See <https://www.aja.com/solutions/thunderbolt> for more information about Thunderbolt.

Bi-directional SDI I/O

Four bidirectional BNC connectors can be configured via the AJA Control Panel for:

- HD/SD inputs (x2) and outputs (x2)
- Or you can input or output 4 channels of video representing individual quadrants of the higher definition UltraHD (3840x2160) and 4K (4096x2160) formats.

NOTE: *The Io 4K can only be configured for either input or output of UltraHD or 4K at a time. It cannot support input and output at the same time since both require four BNCs.*

Dedicated SDI HD/SD Output

NOTE: *One BNC connector is provided for full-time, real-time output of HD/SD video. 4K video is down-converted to 2K HD and UltraHD is down-converted to HD.*

Installing Io 4K/XT Software

NOTE: *Always uninstall previous versions of Io 4K/XT software before updating your software.*

Download

Go to the AJA website and download the latest Io 4K/XT driver software containing the AJA Control Panel application:

<https://www.aja.com/en/support/downloads/>

System software updates may occasionally become available to AJA Io 4K/XT owners on our website (www.aja.com). We recommend checking occasionally for both software updates and additional product information.

NOTE: If your computer has previously had another video capture or multimedia device installed, ensure you uninstall any related software before installing Io 4K/XT. This will prevent any hardware or software conflicts.

Software Package Installation and Re-installation

Before installing the Io 4K/XT software package, ensure that your capture/editing application is installed as detailed in its user documentation. You cannot use Io 4K/XT with a third-party application until the application has been installed and run at least once on your workstation. Next, install the AJA software package.

If you add Io 4K/XT supported applications at a later date and have not previously installed the appropriate drivers, you must run the install program again selecting the appropriate application support software to be installed.

Firmware Update Procedure

After the AJA Software Package has been installed on a computer connected to your AJA hardware, the firmware on that AJA device can be updated if a newer version of firmware is included with that software package.

1. Open the AJA Control Panel application.
2. If more than one AJA device is connected, choose the device you want to update by selecting its name from the drop-down menu at the top of the screen.
3. Go to the Control Panel Firmware Screen.
4. Select the firmware version (if multiple versions exist) in the Desired dropdown.
5. Click on Install. Messages appear and when finished, firmware update completed messages are shown ([Figure 3](#)).

Figure 3. Update Completed Messages

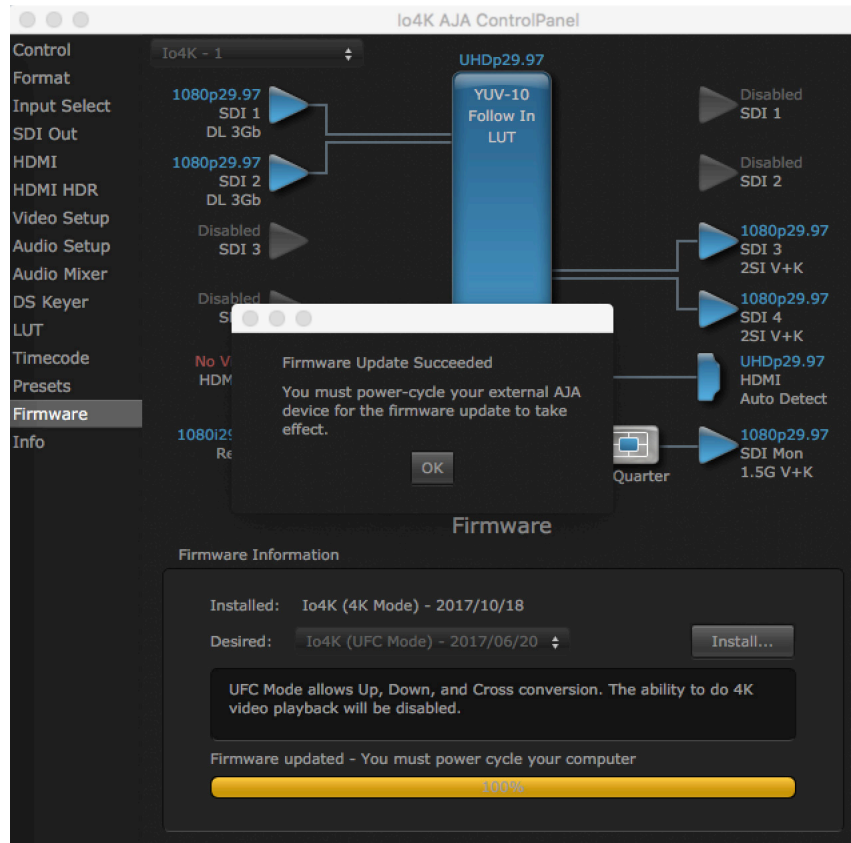

6. Click OK and then power cycle the computer by shutting it down completely.
7. After the computer has shut down, power cycle the AJA device by disconnecting and reconnecting its power plug. If the unit is an io XT, press the front power switch.
8. Restart the computer.
9. Open AJA Control Panel. The AJA hardware with the updated firmware should be recognized by the Control Panel application.

Firmware Versions

Io 4K supports two different versions of firmware that have different capabilities. One version of firmware can be installed at a time.

- Io 4K (UFC Mode) - When UFC firmware is installed, Io 4K supports up, down and cross conversion between 2K, HD, and SD video formats. This version does not support UltraHD/4K playback or capture.
- Io 4K (4K Mode) - When 4K firmware is installed, Io 4K supports input and output of UltraHD/4K, 2K, HD, and SD video, and down-conversion of UltraHD/4K to 2K/HD video on the monitor output BNC. In 4K Mode Io 4K also provides the Audio Mixer screen, to control audio monitoring.

NOTE: Io XT supports only one version of firmware, for 2K/HD/SD capabilities.

Chapter 3 – Io 4K/XT Operation

Figure 4. Io XT Front Panel Controls and Indicators

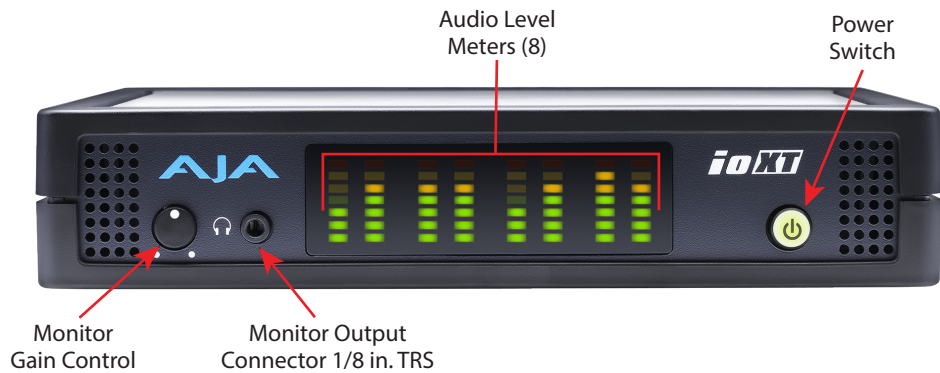
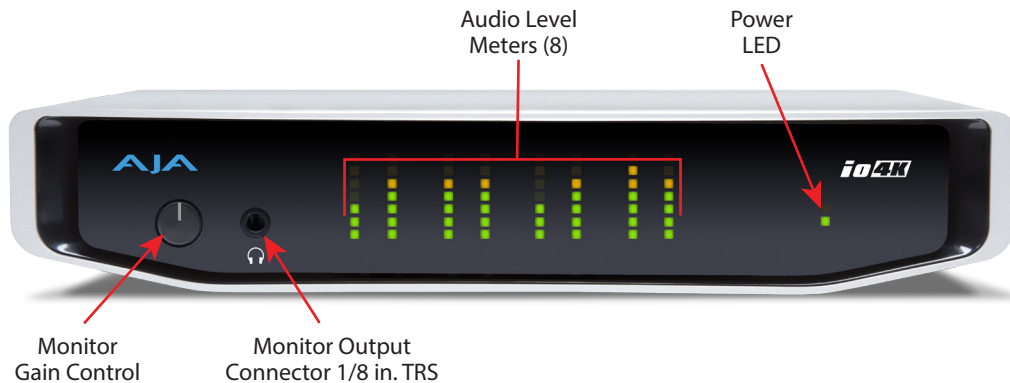

Figure 5. Io 4K Front Panel Controls and Indicators



Front Panel Operation

The io 4K/XT front panel has the following controls and indicators:

Monitor Output and Gain Control

A 1/8 inch TRS connector is available for monitoring two channels of audio, selectable in channel pairs using the Control Panel application. Typically used with a pair of headphones.

The Monitor Gain knob on the left adjusts the monitor output level. Pushing in the knob extends it (for adjustment) or recesses it (to prevent accidental changes).

Audio Level Meters

The Audio Level Meters in the center of the front panel indicate:

- During Capture - The first 8 channels of the audio source selected (SDI, HDMI, Analog).
- During Playback - The sum of whatever sources are being played out via the AJA hardware; i.e. NLE timeline and mix of host system audio output (if applicable).

The meter's LEDs are colored to indicate the amount below 0dBfs when averaged over a one millisecond time interval:

dBfs	LED Color and Location
-2 db	Red LED 1 (top)
-12 db	Yellow LED 2
-20 db	Yellow LED 1
-30 db	Green LED 4
-40 db	Green LED 3
-50 db	Green LED 2
-60 db	Green LED 1 (bottom)

NOTE: These audio level meters are for guidance only. Third-party audio metering should be employed when doing critical audio editing and mixing.

Power Switch (Io XT)

When the power supply is plugged in and receiving power, pressing the power switch toggles power on and (when held for one second) powers the unit off. The switch lights green when the unit has power.

Power LED (Io 4K)

The power LED lights up yellow when power is provided via the power supply. Once a Thunderbolt 3 connection is made, and the host is in an active state, the light turns green.

AJA Control Panel Overview

NOTE: This section initially describes the Io XT version of the Control Panel screens that support video formats up to 2K bandwidths. Io 4K differences will be noted and detailed UltraHD/4K operations are discussed in ["Using Io 4K for UltraHD/4K" on page 43](#).

The AJA Control Panel is a software application that provides a simple visual showing how the Io 4K/XT hardware is currently configured and allows you to make changes. You can change signal input and output parameters and define the video processing that will be performed.

The AJA software installer automatically installs the Control Panel application on your computer. You'll find the AJA Control Panel application in your Applications folder.

AJA Control Panel User Interface

The AJA Control Panel user interface includes a visual block diagram of the unit's current configuration. The current status, input and output settings, and many other details are depicted in the color-coded block diagram. Below this block diagram are various controls for changing operating parameters, which will vary depending on which function screen has been selected.

The left side of the AJA Control Panel provides a navigation list of available function screens. Clicking on a link (or alternatively, a related element in the block diagram) displays a function screen corresponding to that topic.

Figure 6. AJA Control Panel, Block Diagram and Controls

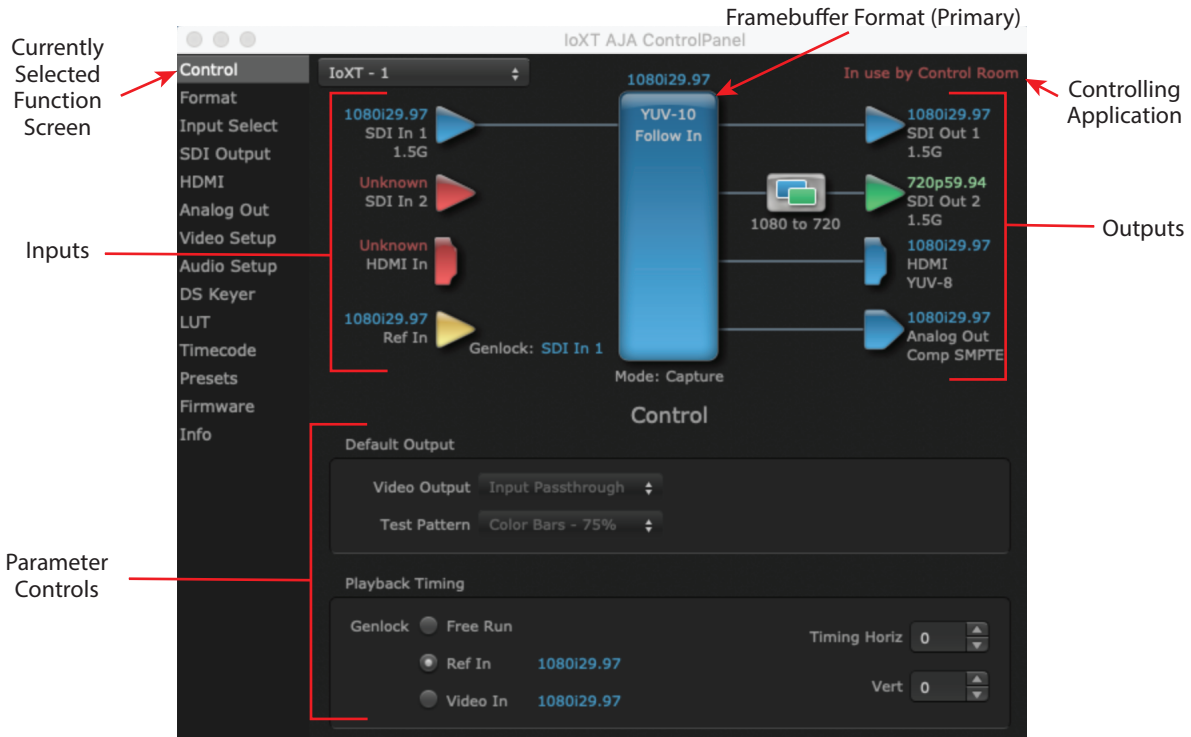

Block Diagram Area

The top block diagram area of the Control Panel screen is a visual representation of the processing, if any, that's currently occurring, including inputs/outputs, reference source, and system status. Lines between inputs, the framebuffer, and outputs, show a video path. Where there are no lines, there is no connection; this can be because an input or output isn't selected in the Input Select menu. The lines will also show whether the outputs are video or video + key.

You can click any of the function screen selection links in the left column to view its current settings or click on an icon to call up its related settings screen. You can also right-click or Control-click to see context-sensitive information and choices (Figure 7).

Figure 7. Context Sensitive Menu

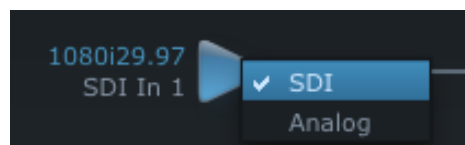

Color Meanings

All items in the AJA Control Panel block diagram are color-coded to show what is happening in realtime. This applies to both icons and text. These colors indicate:

Blue - Video is same format as the Primary Format (framebuffer)

Green - Indicates that Io 4K/XT is performing an active change to the video making it different from the Primary Format (e.g., down-conversion).

Yellow - Reference video (black burst or other reference source)

Red - The selected operation cannot be performed

Input/Output Icons

The input and output icons are triangles that together with their color show all the input and outputs and their status (selected, not selected, input present or not, format, etc.). A complete video path is shown when inputs and outputs are connected with lines going to/from the framebuffer.

Figure 8. Input/Output Icons

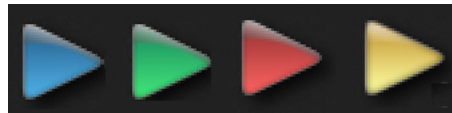

Framebuffer

The framebuffer is the “engine” where your third-party applications interface with the AJA device. The framebuffer has a format (called the “Primary Format”) and color space that it follows, as defined in the linked menu screens or via external application software. The “Secondary Format” is a selection for format conversion.

Primary Format

The Primary Format is the media format written to disk and used in your project. This is the format that the framebuffer will use and is shown in the Control Panel using the color blue. It is the format that the third-party application software will either receive from the AJA hardware, or is sending to the hardware. All icons in blue are the same as the Primary Format used by the framebuffer. Also any text descriptions in the block diagram that appear in blue indicate that something is in the primary format. For example:

- If the input and output icons are blue, you know that the same format is used throughout the video path. No format conversion is being performed.
- If the input or output icon colors differ (blue input and green output icons for example), you know that a format conversion is being performed.

Secondary Format

NOTE: Secondary Format controls are only available on Io XT and Io 4K in UFC mode.

Any format other than the currently selected Primary Format, is a secondary format. As described previously, this means that either the Inputs or Outputs are somehow different from the framebuffer’s assigned format—the Primary Format. A conversion is readily apparent because of the color change from blue.

NOTE: In some cases the application you use with the Io 4K/XT will automatically set the Primary Format, overriding the user’s selected primary format in the AJA Control Panel.

Format Conversion

Format function screen conversion allows selection of a video format conversion. The choices offered depend on the AJA device present in your system, the installed firmware version, and the Primary and Secondary format selected.

IMPORTANT: Do not confuse this Format function screen conversion, which uses AJA hardware and operates on either Mac or PC, with the separate Conversion function screen, which uses QuickTime software codecs for conversion and is only available on Mac.

Conversion Icons

When an input or output is a different standard than the framebuffer, the Io 4K/XT may be up- down- or cross-converting the signal to the selected standard. This may be automatic, because it's detected an input signal that differs from the standard currently selected, or because you've explicitly told it to convert. In either case, the block diagram will show the conversion by displaying a conversion icon in between the input/output and the framebuffer.

Figure 9. Up, Down, and Cross-Convert Icons



Controlling Application

It is important to understand that the computer can contain many applications that can use the AJA device (as you switch from window to window) and it may not always be obvious which currently controls it.

Figure 10. Control Panel In Use Message (in red)

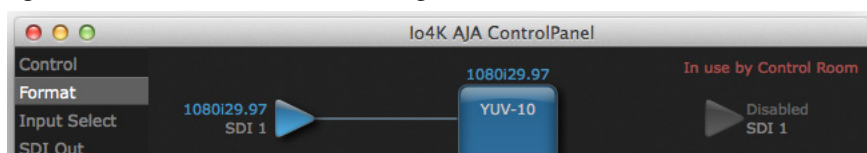

In the top right corner, the Control Panel displays the name of the application controlling the unit. In some cases, applications may not always properly “let go” of the I/O interface as another takes over—you’ll be able to tell by looking at the Control Panel.

Presets

Setups can be named and saved as a snapshot (Preset) for recall at any time. You can save various Control Panel configurations associated with your frequent tasks. You don’t have to spend time resetting interface configurations—just load the previously saved Preset for each task. If you work on multiple systems and want to carry your saved setup to another location, you can copy your saved Presets file on to movable storage and load it into any computer running the AJA Control Panel application. Presets are described in more detail later in this manual.

Single-User & Shared Preferences

When an AJA device starts up, preferences can determine what settings it will have it when it begins to operate. The AJA Control Panel offers preference settings that support both:

- User Preferences— Preferences stored from the last Control Panel State to be used on next startup of AJA Control Panel.
- Shared Preferences— Preferences saved by an Administrator for use as a default start state for AJA Control Panel.

User Preferences

This file exists to immediately, automatically, store preference changes made by a user on a particular AJA device. When any control is changed in the Control Panel, that change is recorded in the preferences file stored in a unique user preferences location dedicated to that particular device and serial number. Then, when AJA control panel is restarted for any reason, it will restart with the same preferences it used when it closed.

However, if a user sets their preferences, and then replaces the AJA device with a different one, the Control Panel will either:

- Start up with the factory defaults, or
- Start up with the “house defaults” dictated by the system administrator (if a Shared Preferences file exists).

The User Preferences file can be found in the following locations.

On Mac:

- /Users/<USER_NAME>/Library/Preferences/com.aja.devicesettings

On Windows:

- C:\Users\<USER_NAME>\AppData\Local\Aja\com.aja.devicesettings

Shared Preferences

An administrator can establish house standards for the AJA Control Panel by creating the user preferences file (described above) and placing it in a shared location where it will establish a standard default startup state for all users of a given computer system. These settings preempt the initial AJA default settings.

To establish the House Default for every user on every system, a system or network administrator can move this default file to all systems on the network (manually or by pushing it out across the network). All users on the network will then open to the House Defaults when they launch the AJA control panel for the first time.

NOTE: If the user makes changes to the control panel themselves, those changes will be saved in their user preferences, which will take priority over the house default dictated by the shared preferences file.

The Shared Preferences file should be a file created at the User Preferences location described above, and placed by the System Administrator in the following locations.

On Mac:

- /Users/Shared/Library/Preferences/com.aja.devicesettings

On Windows:

- C:\Users\All Users\Aja\com.aja.devicesettings

Function Screens

Listed below are the function screens for Io 4K/XT and what they are used for.

Table 2. Io 4K/XT Function Screens

Screen	Functions
Control	Configure some basic operation options and output timing.
Format	Select the framebuffer primary video format and any secondary formats for conversion of inputs/outputs.
Input Select	View and edit input selections and audio mapping.
SDI Output	Select output format.
HDMI	Configure the HDMI I/O.
HDMI HDR	(Io 4K in 4K Mode only) Configure High Dynamic Range settings for HDMI output.
Analog Out	(Io XT only) Configure the component format and audio monitor setup.
Video Setup	Configure Video such as composite black level, progressive format and ancillary data (Closed Caption) option.
Audio Setup	Configures Audio options such as analog audio monitor level.
Audio Mixer	(Io 4K in 4K Mode only) Select and mix audio sources for playback and capture.
DS Keyer	Setup and control the insertion of keyed video from the framebuffer or graphics files with alpha channel.
LUT	Load a lookup table (LUT) file to adjust the calibration of color for any source.
Timecode	Monitors SMPTE 12M-2 timecode and configure timecode window burn output.
Presets	Add or delete saved preset configurations (handy for quick and easy recall of different Io 4K/XT settings for varied workflows).
Firmware	Install device firmware from your currently installed AJA software package.
Info	Display status information and the firmware version number. This information is generally intended for troubleshooting/support.

Using Io XT and Io 4K for HD, SD, 2K

In this section, standard SD, HD, and 2K Control Panel operations are described. These are essentially the same for both Io XT and Io 4K and are illustrated using Io XT screen shots (exceptions are noted).

Control Panel operation for Io 4K using UltraHD and 4K formats are described separately (see ["Using Io 4K for UltraHD/4K" on page 43](#)).

Control Screen

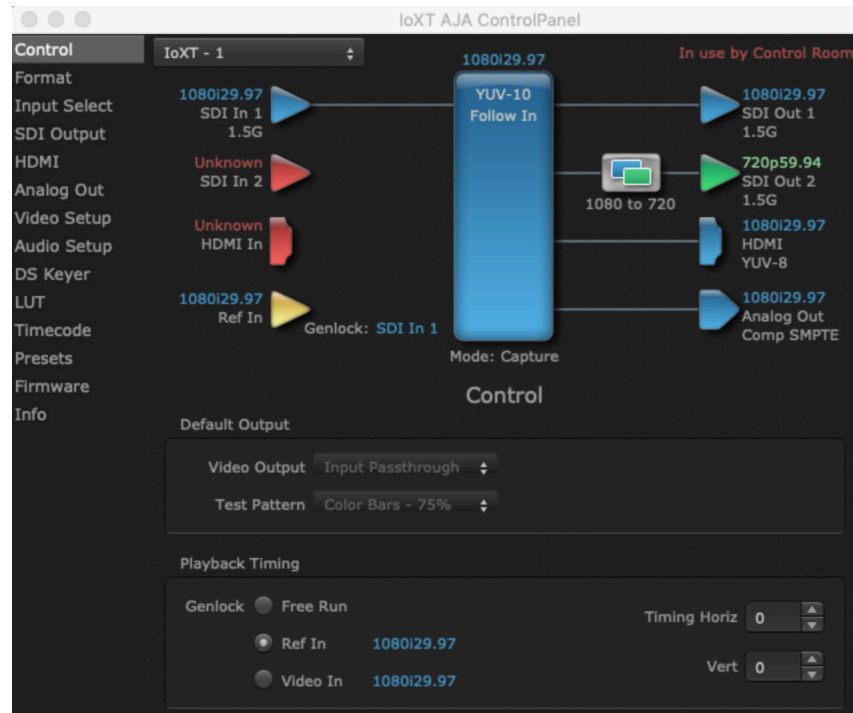

The Control Screen is where you set the Default Output, what the device outputs when no application has control of the board. This screen also has controls for setting the genlock source, and for setting the Horiz and Vert timing offsets. The top of the Control Screen shows the current state of the device and also shows the name of the Application which has control of the board, if there is one.

Default Output

Many video applications can grab control of the lo 4K/XT, so its outputs can change dynamically. The Default Output settings are used to select what will be output when no third-party video application is controlling lo 4K/XT.

Video Output

- Input Passthrough - This selection directs lo 4K/XT to route video from its selected input through the card for processing and output.
- Test Pattern - This selection directs lo 4K/XT to output a preset pattern when no other application is in control. The pattern is selected from the Test Pattern dropdown list below, or a graphic file can be chosen.
- Hold Last App - This selection directs lo 4K/XT to hold and output the last frame of video from the last application to control lo 4K/XT. This can be helpful when operating in an environment where you're switching back and forth between multiple application windows.

Test Pattern

With Test Pattern selected above, you can choose the pattern type. Select from:

- Black, Color bars (75% or 100%), Ramp, Multiburst, Line Sweep, Multi Pattern, or Flat Field, Check Field, White, Border, Linear Ramp, Slant Ramp, Zone Plate, Color Quadrant, or Color Quad Border.

Graphic File Display

In addition to the test patterns above, a “Load File...” selection at the bottom of the Test Pattern dropdown menu allows you to load a standard RGB/RGBA graphics file (.tif,.psd, etc.) into the frame buffer for display (including alpha channel). Some graphics formats and bit depths may not be supported. Files that have been loaded are listed for quick reuse. Loaded graphic files are retained for redisplay if another test pattern is selected, and even if lo 4K/XT is power cycled.

NOTE: A loaded graphics file will not be scaled to fit. If it's smaller than the current frame buffer format, lo 4K/XT will center it in the frame. If larger than the current frame buffer format it will be cropped.

- Clear Files - This selection on the pulldown clears all the Graphic Display files.

Playback Timing

Use these controls to set the Genlock source and Timing adjustment.

Genlock

Selects how lo 4K/XT will synchronize program video:

- Freerun: Generates sync without an external reference source
- Ref In: Use the Ref Video source for sync (usually an analog black burst video signal)
- Video In: Use whichever video input source has been selected in the Inputs screen for sync

For video stability and proper system operation, you can genlock all equipment to house sync. However genlock is not required for lo 4K/XT due to its excellent freerun accuracy. On the lo 4K/XT house sync is connected to “LTC/Ref In”.

Alternatively, lo 4K/XT can receive externally supplied Linear Time Code on that same input connector. The LTC/Ref setting on the Input Select screen (see "[LTC/Ref](#)" on page 28) selects how that input signal will be used.

Timing (Horiz and Vert)

These two pull-downs allow output timing adjustment with reference to the Ref Video source selected.

- Horizontal: The Horizontal reference can be adjusted by selecting a number of pixels (clocks) to offset
- Vertical: The vertical reference can be adjusted by specifying a number of lines to offset.

Format Screen

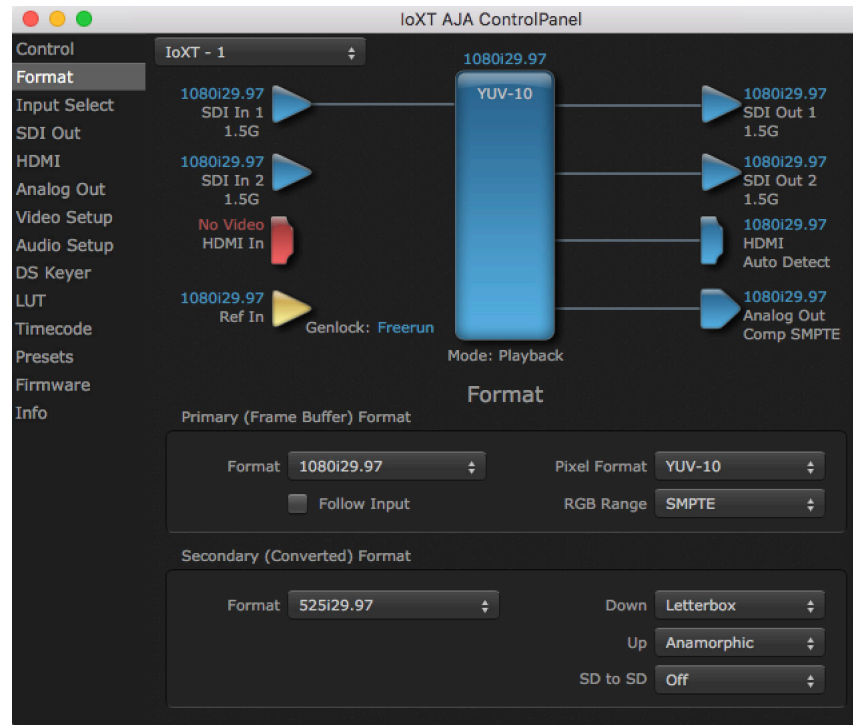

The Format screen shows the video format currently in use by the lo 4K/XT framebuffer (called the Primary Format) and allows you to change it.

All throughout the Control Panel, choices are always presented based on what lo 4K/XT can do with the signals available and the inputs/outputs selected. For example, on the Format screen, if the output or inputs are a different format than the primary, then you'll see an additional information pane that allows you to view and edit the secondary format—including control over whether up/down/cross conversion is employed.

NOTE: lo 4K in 4K Mode does not support a secondary format for up/down/cross conversion.

NOTE: The AJA Control Panel software uses the abbreviation "sf" instead of "Psf" when referring to "progressive segmented frame" formats.

Primary (Frame Buffer) Format

Format

This pull-down menu shows the currently selected format. When a change is made via the Video Format pull-down or by clicking an icon and selecting a new format via a contextual menu, the block diagram will change to reflect the new format.

NOTE: The Format control is not active when an application has control of the lo 4K/XT.

Follow Input

Enabling the Follow Input checkbox allows the Control Panel Buffer to auto-switch to whatever is the detected input format. This feature works if the controlling application supports input-based capture—Avid Media Composer or AJA Control Room for example. Follow Input can also be active when there is no 3rd party controlling application and the Default Output setting is Input Passthrough (see "[Video Output](#)" on page 23).

Pixel Format

Use this pulldown menu to choose from:

- YUV-10, YUV-8, RGB-10, ARGB-8, or RGB-12

RGB Range

The RGB Range pulldown menu allows you to select either:

- Full range (0-1023)
- SMPTE range (typically 64-940) for RGB color output.

NOTE: RGB Range is only used when the SDI input or output is configured for RGB.

Secondary (Converted) Format (lo XT and lo 4K in 4K Mode)

This pull-down menu lists all compatible formats for conversion (incompatible formats are not shown). This allows you to see what you've chosen, and also see those formats that are compatible with the selected Primary format.

Cross-Conversion

If you have an HD format as your primary and then select a secondary HD format with a different frame size, the lo XT will perform a cross-conversion where necessary (input or output) for "like Hz" formats. "Like Hz" means that 720P 59.94 may be converted to 1080i 29.97 (59.94Hz). Converting from disparate Hz is not supported on the lo XT for cross-conversions. The example below shows 1080i to 720p.

Down Conversion

For down-conversion the following choices are available:

- Letterbox: image is reduced with black top and bottom added to image area with the aspect ratio preserved
- Crop: image is cropped to fit new screen size
- Anamorphic: full-screen "stretched" image

Up Conversion

For up-conversion the following choices are available:

- Anamorphic: full-screen "stretched" image
- Pillar box 4:3: results in a 4:3 image in center of screen with black sidebars
- Zoom 14:9: results in a 4:3 image zoomed slightly to fill a 14:9 image with black sidebars
- Zoom Letterbox: results in image zoomed to fill full screen
- Zoom Wide: results in a combination of zoom and horizontal stretch to fill a 16:9 screen; this setting can introduce a small aspect ratio change

SD to SD Conversion

This pulldown is for SD to SD aspect ratio conversion.

- Letterbox: this transforms SD anamorphic material to a letterboxed image.
- H Crop: will produce a horizontally stretched effect on the image; transforms anamorphic SD to full frame SD
- Pillarbox: will produce an image in the center of the screen with black borders on the left and right sides and an anamorphized image in the center
- V Crop: will transform SD letterbox material to an anamorphic image

Figure 11. AJA Control Panel, Formats Screen, lo XT Cross-Conversion

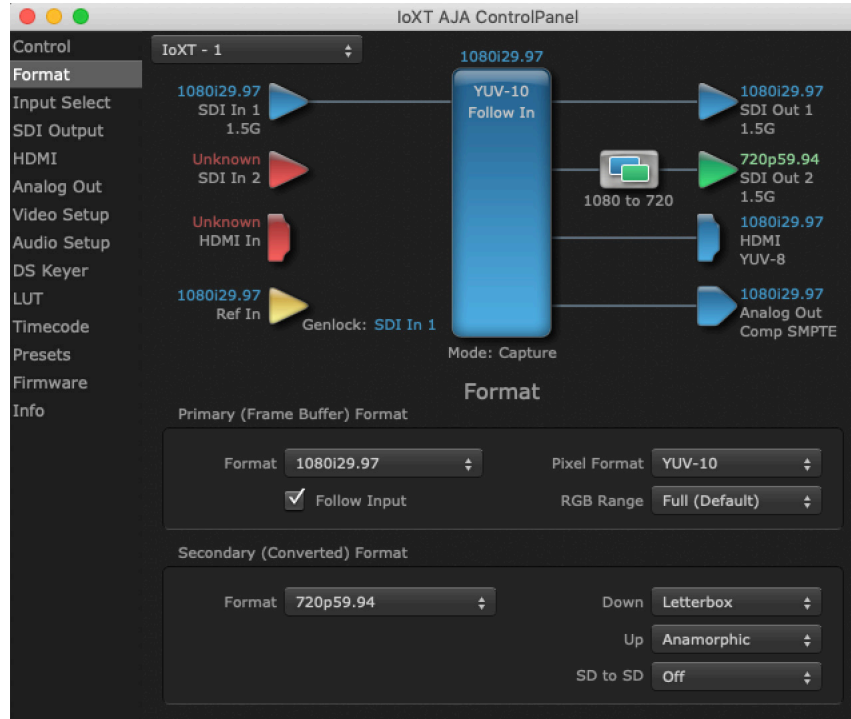

UltraHD/4K Down-Conversion

Io 4K provides a dedicated SDI Monitor BNC that outputs a quarter-size image of a selected UltraHD/4K signal format while operating in 4K Mode. For details, see ["Using Io 4K for UltraHD/4K" on page 43](#).

Input Select Screen



On the Input Select screen you can view or set the currently selected video and audio input sources and map audio sources to the channels supported by your editing application. Two information panes in the screen are provided: Video Input and Audio Input.

Video Input

Source

The Source pulldown menu allows you to see and change what's currently selected and shows the video format that lo 4K/XT has detected (if any). To select a different input use the pulldown to choose from:

- SDI 1, SDI 2, Dual Link, or HDMI

LTC/Ref

Use the LTC/Ref menu pulldown to identify the type of signal being received by the LTC/Ref BNC:

- Reference - BNC is used as a video reference input.
- LTC- BNC is used for linear time code (LTC) input.

SDI Color Sp

Sets the color space. Select from Auto, YUV, or RGB.

SDI RGB Rng

Sets the RGB range. Select from Auto, SMPTE, or Full.

Audio Input

Select

This pulldown menu allows you to pick where the audio comes from. lo 4K/XT supports up to 16 channels of embedded audio, up to 8 channels of HDMI audio. Choose from:

- Auto, HDMI, SDI Ch 1-16, or SDI2 Ch 1-16

Ch Map

Here you can select which two audio input channels will be mapped to your editing application if only two channels (Ch 1 and Ch2) are selected in that application.

- Choose in pairs from 1-2 through 15-16.

Incoming embedded SDI audio supports the routing of all eight channel pairs. HDMI embedded audio supports routing of the first four channel pairs. Analog audio supports routing the first two channel pairs.

NOTE: This setting does not affect the embedded audio being sent to the lo 4K/XT's BNC or HDMI output connectors.

SDI Output Screen

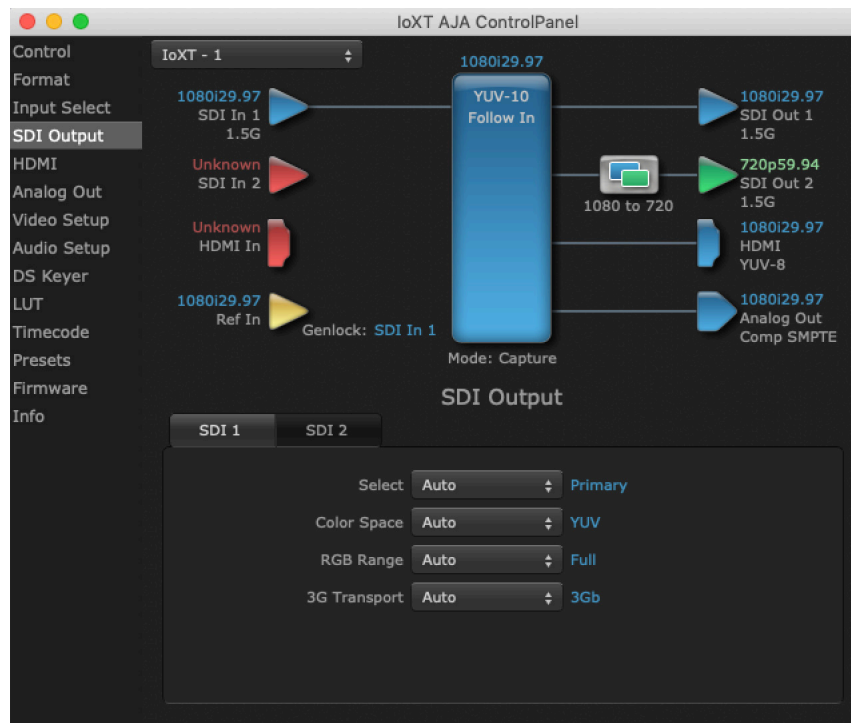

The SDI Output screen shows the current settings for the SDI outputs. Because the outputs can be configured independently, one output may be the Primary format and the other output may be the Secondary format. If an input/output has no video, it will be indicated on the block diagram (“No Video”).

SDI 1

Select

Configure the SDI 1 Outputs choosing from::

- Primary YUV - The SDI output is set to the same format as the frame buffer with YUV color.
- Secondary - Use the Secondary (Converted) format for output.
- Video+Key - The SDI 1 Output video is set to the same format as the framebuffer. SDI 2 Output is set to a video key signal associated with SDI 1 (the shape to be cut out from the video - this will appear as a black and white image/matte). Using the second output as an Alpha Channel key, with the video output, may be useful for feeding production switchers, DVEs or other professional video equipment.

Color Space

Sets the color space. Select from Auto, YUV, or RGB.

RGB Range

Sets the RGB range. Select from Auto, SMPTE, or Full.

3G Transport

Sets the output transport. Select from:

- Auto - Automatically selects the transport, based on the input or selected format.
- 2xHD-DL - Dual link HD output transport, using two BNCs.
- 3Gb
- 3Ga

HDMI Screen

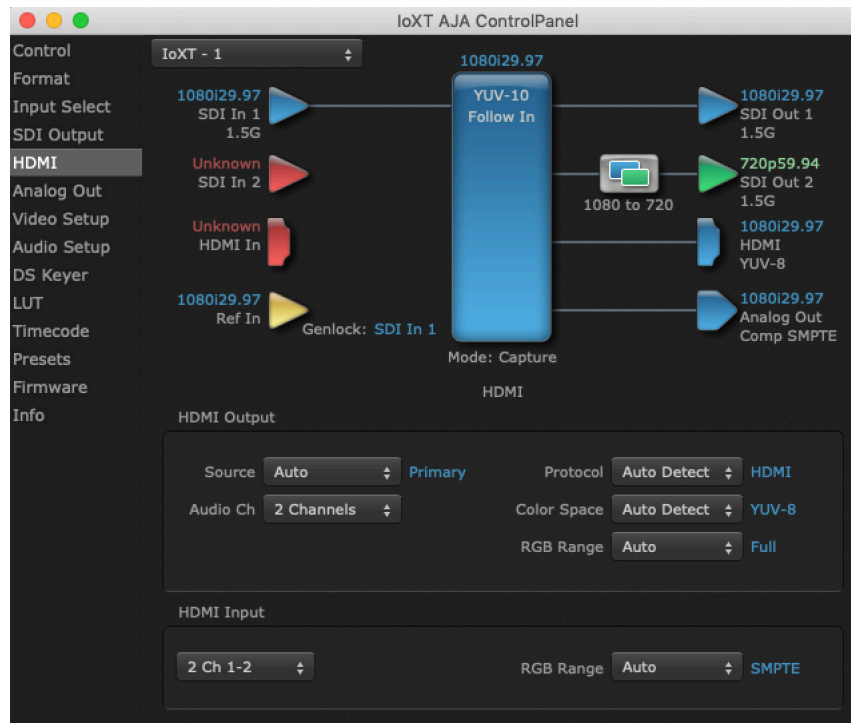

The lo 4K/XT HDMI output and input are configured at this screen. For lo 4K UltraHD and 4K format setup, see ["lo 4K HDMI Screen in 4K Mode" on page 51](#).

HDMI Output

Source

- Auto - Automatically sets the HDMI output format, based on the input or selected format.
- Primary - Selects the framebuffer format for output.
- Secondary - Sets the HDMI output to the Secondary format (set in the Format screen) for up/down/cross-conversion).

NOTE: The 4K Transport setting on the SDI Out screen also affects the lo4K HDMI output signal, even if the SDI inputs are not being used. A SMPTE 2Si setting is required for UltraHD/4K HDMI output. Other 4K Transport settings will downconvert HDMI output to HD or 2K.

Audio Ch

This pulldown allows you to select the number of embedded audio channels for the HDMI output. Two or eight channels can be chosen. Select from:

- 2 Ch 1-2 through 15-16
- 8 Ch 1-8
- 8 Ch 9-16

Protocol

The Protocol pulldown allows you to choose Auto Detect, HDMI or DVI protocol—use DVI if you're outputting to a DVI monitor using an HDMI to DVI adapter.

Color Space

Selects the HDMI output color space and depth. Select from:

- Auto Detect – Automatically selects the mode based on the attached HDMI device's EDID information. This is the recommended setting. The selected mode is shown to the right of the pull-down control.
- RGBA-8 - Uses 8-bit RGB mode regardless of the attached device's EDID.
- RGB 10 - Uses 10-bit RGB mode regardless of the attached device's EDID.
- YUV-8 - Uses 8-bit YCbCr mode regardless of the attached device's EDID.
- YUV-10 - Uses 10-bit YCbCr mode regardless of the attached device's EDID.

RGB Range

The RGB Range pulldown menu allows you to select the type of RGB color output.

- Auto
- SMPTE– (typically 64-940)
- Full–(0-1023)

HDMI Input

Audio Channel Selection

This drop down menu specifies the incoming HDMI audio channels. Select from:

- 2 Ch 1-2, 3-4, 5-6, or 7-8 - Inputs only the indicated two HDMI audio channels.
- 8 Ch 1-8 - Inputs all eight HDMI audio channels.

RGB Range

The detected HDMI input video format is displayed and you're given a chance to configure the RGB range (SMPTE or FULL).

Analog Out Screen (Io XT Only)

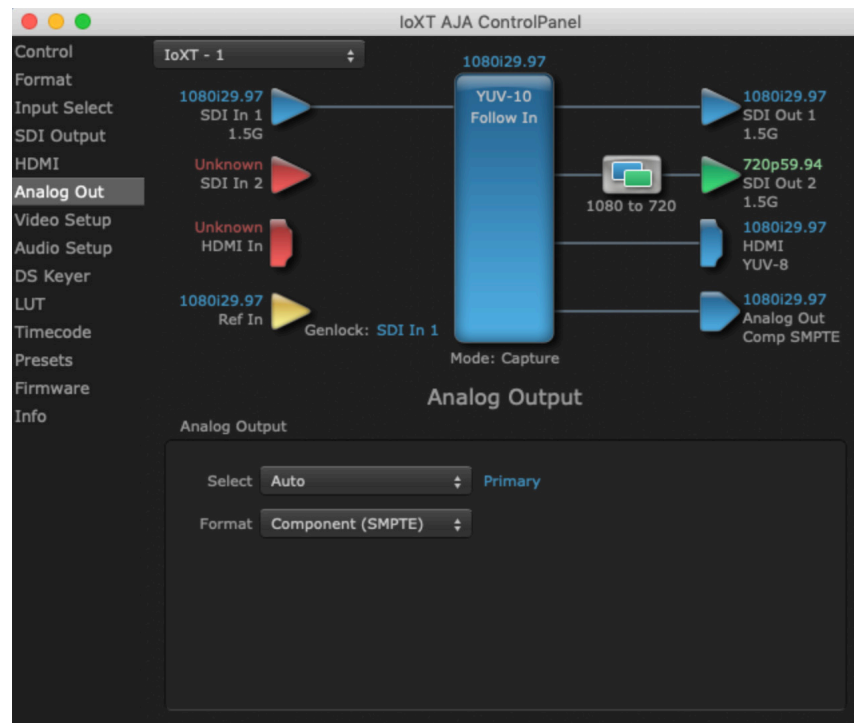

Io XT provides a high-quality analog component or composite + Y/C output, generally used for monitoring. This screen shows the current settings for that analog output, and allows you to re-configure it when desired.

Analog Output

Select

Sets the analog output format. If a conversion is applied, you'll see the conversion icon appear on the block diagram.

- Auto - Automatically sets the analog video output format, based on the input or selected format.
- Primary - Selects the framebuffer format for output.
- Secondary - Sets the HDMI output to the Secondary format (set in the Format screen) for up/down/cross-conversion).

Format

Select the video format from the Format pulldown.

- Composite + Y/C
- Component (SMPTE)
- Component (Beta)
- Component (RGB)

Video Setup Screen

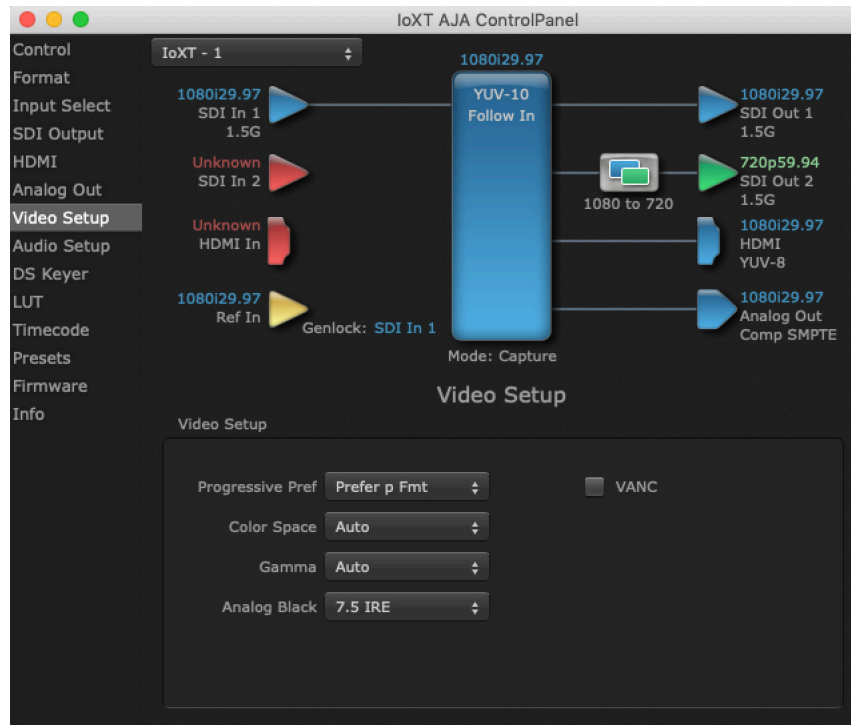

The Video Setup screen shows various other settings which will affect how video inputs and outputs behave, and how lo 4K/XT interacts with some software applications.

Video Setup

Progressive Pref

Allows you to choose to prefer p (progressive frames) or PsF (progressive segmented frames) on non-interlaced output. This feature is used to default the hardware to use either p or PsF output over SDI when it has not been specified by the application.

NOTE: *If you change this option while your NLE is open and running, you may need to then make a change in one of your NLE settings in order for this to be reflected dynamically in the project. For example in Media Composer, simply toggling the Video Quality menu in the Timeline will cause a project format refresh to occur, thus recognizing the change you just made in Control Panel.*

Color Space

Sets the video color space. Select from:

- Auto
- Rec 601 -
- Rec 709 -

Gamma

Sets the video gamma. Intended for use with legacy Apple displays. Select from:

- Auto
- Gamma 1.8

Analog Black (in lo XT only)

Choices available for Black Level are the two Composite analog formats. Choices presented are for US or Japan:

- 7.5 IRE (NTSC US)
- 0 IRE (NTSC Japan)

VANC Checkbox

When checked ON, the VANC checkbox tells the lo 4K/XT to capture and process any ancillary data in the SDI stream. This can include Closed Captioning data, and other types of metadata. Applications such as Premiere Pro and Final Cut Pro will not capture or output this data through the loXT if this box is not checked on.

NOTE: lo4K does not require enabling the VANC checkbox for Closed Captioning.

Audio Setup Screen



The Audio Setup screen shows the current settings for the analog audio output, allowing you to re-configure it when desired. The lo 4K screen is shown because the Audio Delay settings it supports are not available on lo XT.

Audio Monitor

Monitor Channels

This control selects which pair of channels from the NLE will be monitored. For most editing scenarios this should remain as Ch 1-2, since most NLEs default to dual track / stereo monitoring as a sum of the entire timeline.

NOTE: This setting only applies to dual channel monitoring environments (for example, the headphone jack on the front of the lo 4K/XT).

Select from:

- Ch 1-2 through Ch 15-16

Monitor Level

This selection determines the analog audio output level (“FSD” is full-scale-deflection reading as measured on a VU meter). In addition to the front panel monitor (headphone) output, this setting also effects the analog output via the DB25 cable. Select from

- +24dBu, +18dBu, +15dBu, or +12dBu

Audio Configure (lo 4K Only)

Here you can set up to 6 frames (in tenths of a frame) of delay for the AJA device’s audio input and output. The AJA Control Panel delays all audio outputs—SDI, HDMI, and Analog

IMPORTANT: If you use this Control Panel delay, do not use other delay settings in your applications. They can conflict.

DS Keyer Screen

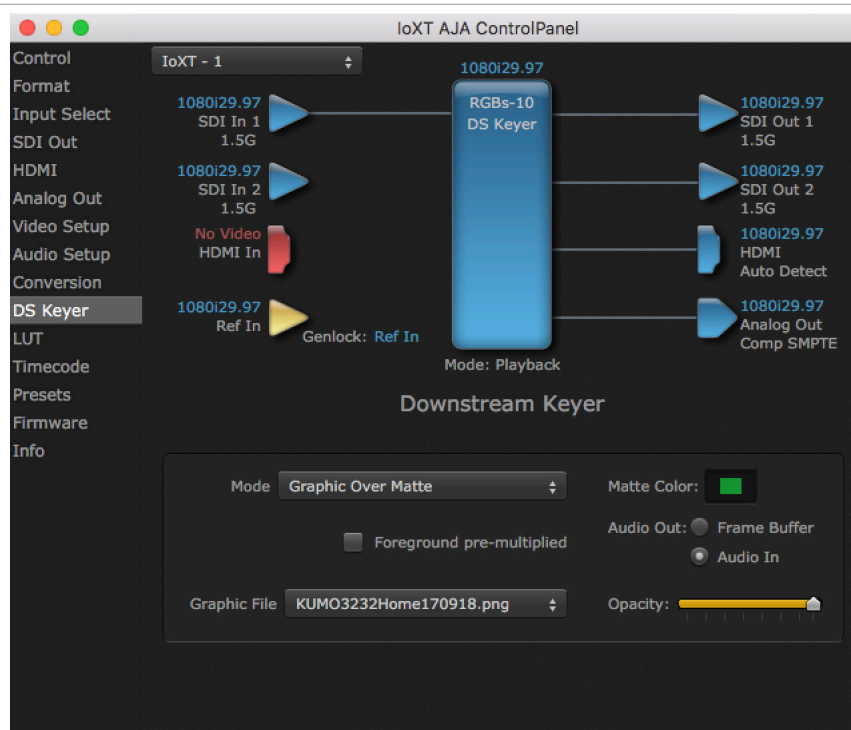

The lo 4K/XT has a hardware-based downstream keyer that is ideal for putting logos, “bugs” or other video material with an alpha channel on top of video being played out or printed to tape.

NOTE: lo 4K does not support Downstream Keying in UltraHD and 4K formats.

A typical application would be putting a television station’s call letters or channel over program video content. Keyed video can be from the lo 4K/XT internal Frame Buffer (from storage, video In, etc.) or from a graphics file that has an alpha channel (PhotoShop etc.).

Settings in the DS Keyer Screen provide control over how the keyer operates and whether it’s turned on or off.

Downstream Keyer

Mode

Downstream Keyer Off - When this pulldown menu item is selected the downstream keyer will be turned off

- Frame Buffer over Matte - Places the keyed video with alpha channel currently in the Frame Buffer over a fixed color matte determined by the "Matte Color" setting set separately.
- Frame Buffer over Video In - Places the keyed video currently in the Frame Buffer over the video input for playout or print-to-tape.
- Graphic over Matte - Places a graphics file having an alpha channel (chosen in "Graphic File" pulldown) over a fixed color matte determined by the "Matte Color" setting set separately.
- Graphic over Video In - Places a graphics file having an alpha channel (chosen in "Graphic File" pulldown) over the video input for playout or print-to-tape.
- Graphic over Frame Buffer - Places a graphics file having an alpha channel (chosen in "Graphic File" pulldown) over the current contents of the Io 4K/XT Frame Buffer (which might be from storage, video In, etc.).

Matte Color

Only available when the pulldown "Frame Buffer over Matte" or "Graphic over Matte" are selected-pressing this button brings up a color selection dialog. The dialog provides a variety of ways to select a matte color including a color wheel, color picker (choose from a location anywhere on the computer screen), numeric sliders, swatches, "crayons", and spectrums. The matte chosen will be used as a video background under the keyed video.

Foreground pre-multiplied (checkbox)

Use to avoid "matte lines" and improve the appearance of the foreground (key) being composited over the background.

Audio Out

- Frame Buffer - Select audio out to be routed from the Frame Buffer.
- Audio In - Select audio out to be routed from the Io 4K/XT's selected input(s).

Opacity (slider)

This slider controls the transparency of the keyed video (over the background) from translucent to completely opaque.

Graphic File

This pulldown allows you to choose from any recently accessed file or select a new file ("Load File..."), which then brings up a file dialogue. Remember that the file raster (pixel x pixel count) should match the primary format in the framebuffer or the secondary format if upconverting. Example: you wish to key a logo on top of your 1920x1080 footage, the still image with alpha channel that you load should be 1920x1080.

Figure 12. Graphic Selection and Matte Color Selection

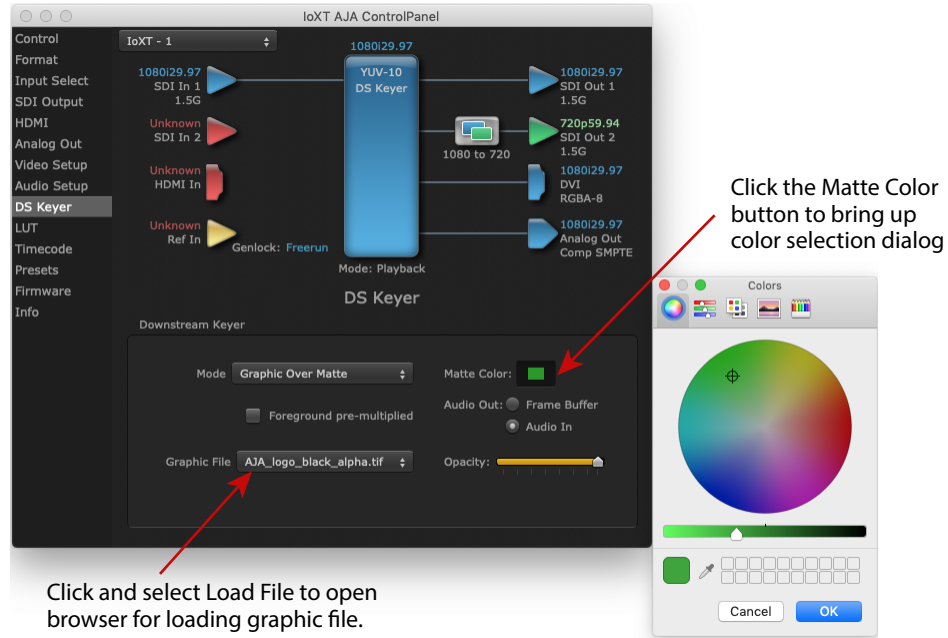

LUT Screen

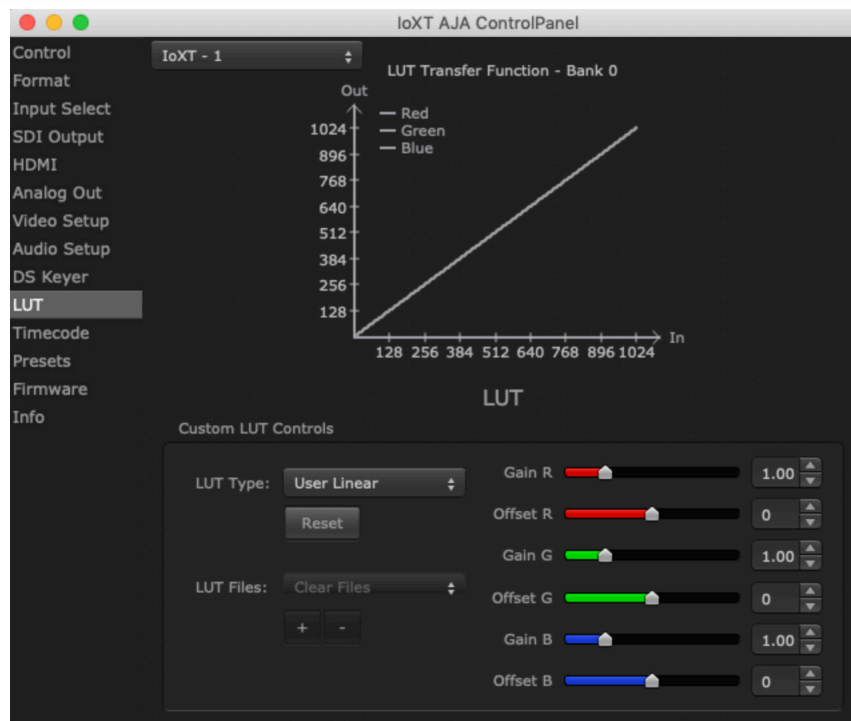

The LUT screen controls allow you to create a custom color look up table (LUT) on the output, for matching a production "look" on a specific display.

Users can also specify their own custom LUTs by creating a LUT file and uploading it to an AJA Video Device using the LUT (lookup table) screen in the Control Panel.

Custom LUT Controls

The LUT Transfer Function screen displays an approximate representation of the effect of the current LUT settings. When the controls are activated by selecting a User LUT Type, Red, Blue, and Green curves show the transfer functions of each color.

NOTE: The displayed curves are approximate. Curves for some extreme settings may diverge significantly from the actual transfer functions.

LUT Type

Selects the type of LUT. Choose from

- Auto - LUT will be automatically selected. This setting intelligently applies the type of LUT required in the majority of use cases. For example, if the Frame Buffer is set to SD 608 and the Output set to HD 709, then an industry standard curve for changing 608 to 709 color space is applied.
- Linear - A linear 1:1 LUT is applied, resulting in no color change (every value for source is mapped to the same value for output).
- SMPTE-FullRange - A conversion LUT from SMPTE to Full Range is applied.
- FullRange-SMPTE - A conversion LUT from Full Range to SMPTE is applied.
- User Linear - Activates the Gain and Offset controls, allowing the manual creation of a custom LUT. Initial default setting is linear.

Figure 13. Example LUT Transfer Function Curves



- User Film Stream - Activates the Gain and Offset controls with a default curve matching Grass Valley FilmStream cameras, and also allowing manual creation of a custom LUT.
- User LUT File - See "[LUT Files](#)" on page 39 .

Gain and Offset Controls

When activated, the controls on the right allow adjustment of Gain and Offset for Red, Blue and Green.

- Sliders - The sliders on the right can be used to change the values for each color.
- Numeric Entry - You also enter a numeric value by clicking on the displayed number, and can increase or decrease the values clicking on the up/down arrow boxes.
- Cut and Paste - Right clicking on a displayed number opens a Cut, Copy, Paste dropdown menu for convenient numeric entry.

Reset

Clicking on the Reset button resets the currently selected LUT Type to its default values (not active for a User LUT file).

LUT Files

Users can specify their own custom LUTs by creating a LUT file and uploading it to an AJA Video Device using the LUT (lookup table) screen in the Control Panel. You can create a custom LUT file using most text editors or spread sheets, provided the data is arranged according to the LUT File Format Specification that follows (see "[LUT File Format Specification](#)" on page 39).

Uploading Custom User LUT File

Once the LUT file is created, you can upload it with the following steps:

1. Before loading a LUT, make sure you are using an RGB/RGBA frame buffer format, and that you have a AJA Video Device that supports LUTs.
2. Open AJA Control Panel and select the "LUT" pane.
3. Click the "LUT Type" popup and choose "User LUT File" menu item. Note "LUT Files" options become enabled.
4. Click the "+" button and use the navigation dialog to choose a custom LUT file. The LUT is now loaded.

LUT File Format Specification

LUT files are normal text files that contain 1025 lines (numbered 0 - 1024). Each line contains 3 integer values in the range 0 - 1023, representing 10 bit R, G, B component output values. Component values may be separated by one or more commas, spaces, or tabs. The example below show LUT File contents for Line 0, Line 1, Line 2, and Line 1024, with several valid ways to separate the numbers in a line.

- 16, 17, 17
- 17 18 18
- 19 19 21
- ...
- 1000, 1022, 1023

In the example above, the first line (Line 0) represents the output values for the case where R=0, G=0, or B=0. In other words, if the R component of a pixel is set to 0, then set R component value to 16. Likewise, if G is set to 0, then set G to 17. The second line (Line 1) does a similar thing for input component values equal to 1.

A simple way to construct a LUT file is to use a Spreadsheet like Excel. Simply fill 3 columns and 1025 rows with LUT data, and save the result as a "CSV" file.

Timecode Screen

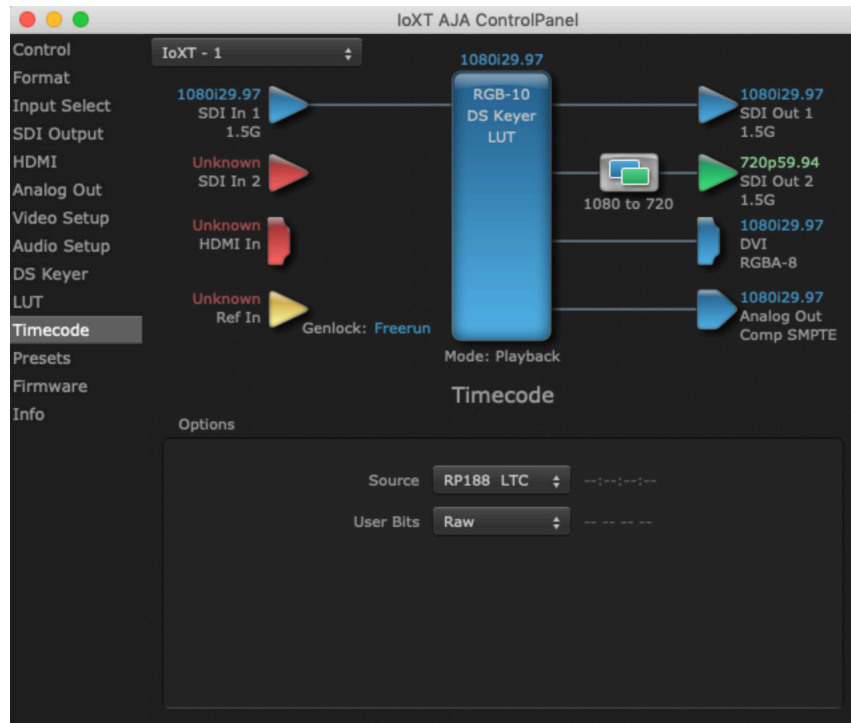

The Timecode Screen selects the timecode stream read for applications that use it (for example, when the timecode source is set to “Use control panel setting,” AJA Control Room will read the selected stream). It is also used for monitoring the RP-188 timecode embedded in the digital data stream.

Options

Source

In RP-188 timecode (SMPTE 12M-2) there can be multiple timecode types in the data stream. Use this pull-down to select the one you wish to monitor:

- RP188 LTC (Linear timecode)
- RP188 VITC (Vertical Interval timecode)
- LTC Port input

The selection will be displayed in the timecode value to the right of the pull-down.

User Bits

Select from Raw or VFR. For monitoring a variable framerate (VFR) timecode (such as Varicam), you may wish to select VFR for User-bits. Io 4K/XT will detect and interpret the user-bits and display them next to the checkbox. You will see the original framerate (30 fps in the figure below) followed by the adjusted frame padding (two digits reporting discarded and retained frame padding).

NOTE: SMPTE 12M-2 is the updated name and specification for what was RP-188.

Presets Screen

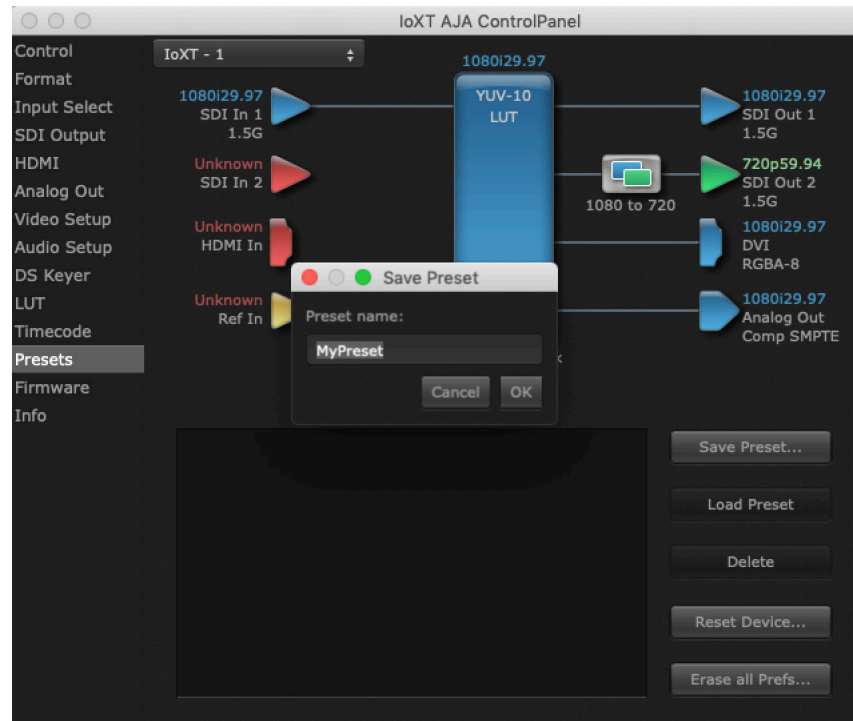

After configuring the AJA Control Panel screens, you can then save all your settings as a snapshot for later recall—called a preset. In this way, you can organize presets for all your typical tasks, eliminating time-robbing manual reconfiguration each time. To save a preset, simply go to the Presets screen and click “Save Preset”. A dialog will be presented asking you for a name; enter a meaningful name and click “OK”. Thereafter the preset will be available under the Control Panel “Presets” list.

Loading and Saving Presets

From the Presets screen you can manage your collection of presets easily. To Load or Delete a stored preset, just select it with your mouse and then click the “Load Preset” or “Delete” button respectively.

Transferring Saved Presets

If you want to use a saved Preset on another workstation, you can simply copy the file on removable storage and install it at the new location. The Preset file is always stored at:

- ~/Library/Application Support/AJA/<device name> Presets/ [on Mac]
- c:\Users\<username>\AppData\Local\AJA\Control Panel\<device name> Presets\ [Windows 8]

Reset to Default

When you click the ‘Reset to default’ button the control panel will delete the User’s preference file and do one of the following:

- If “Shared” preferences exist, they are reloaded and the device is set to this state.
- If the “Shared” preferences file does not exist, “factory defaults” are loaded and the device is set to this state.

Erase all Prefs

For technical support purposes you may be required to remove Preference settings. This button automates that function. If activated, all your preference setting will be lost.

Firmware Screen

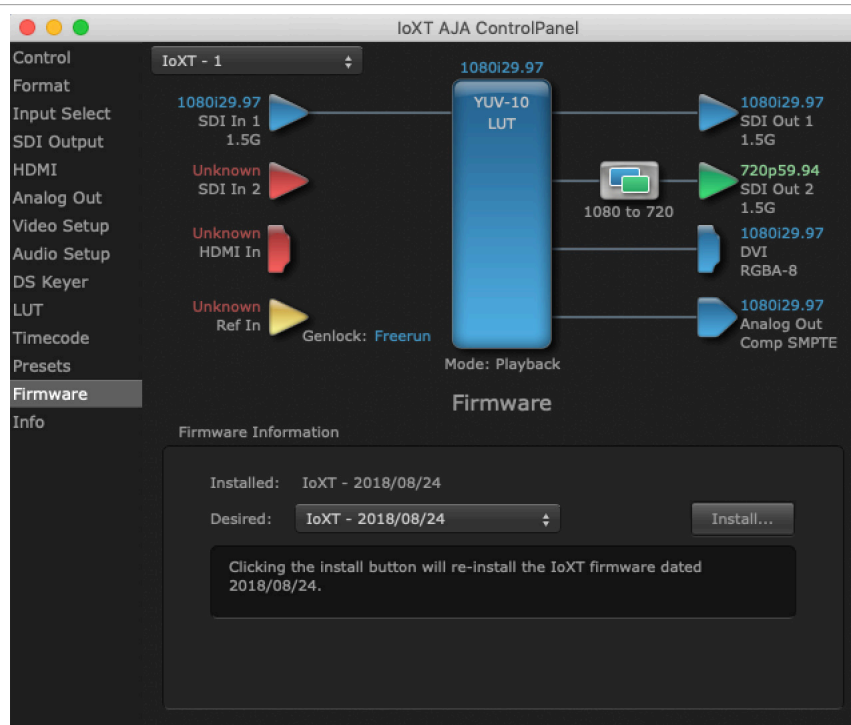

Use the Firmware screen to access the firmware install screen. Click Install to erase current firmware and load the firmware version contained in your currently installed AJA software package.

You will need to power-cycle your computer and Io 4K/XT to finish the update.

NOTE: *Io 4K supports two different versions of firmware (UFC and 4K Modes) that have different capabilities. Io XT supports only one version of firmware, for 2K/HD/SD capabilities.*

See "[Firmware Update Procedure](#)" on page 14 for more detailed information.

Info Screen

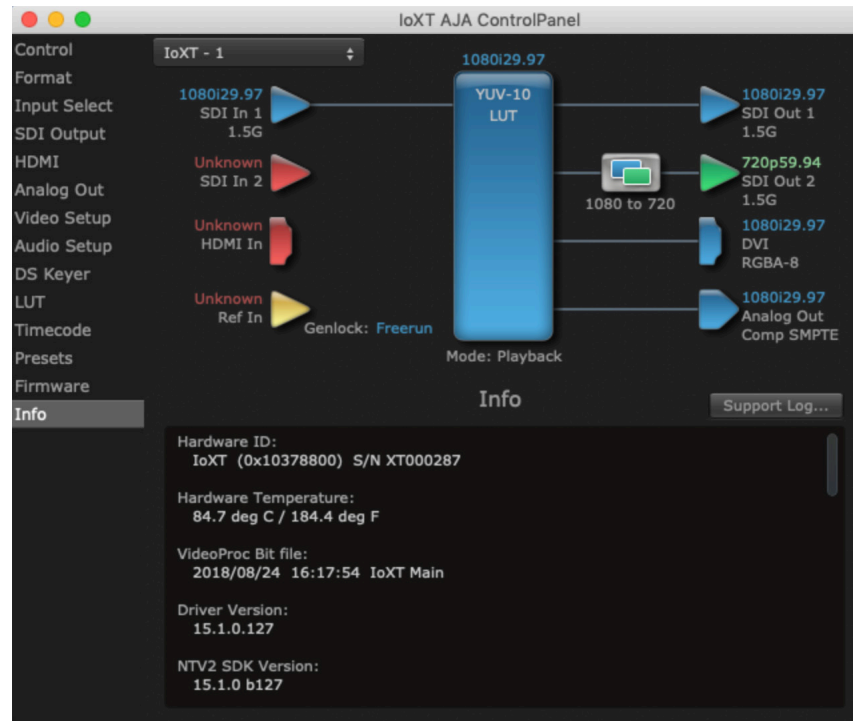

The Info Screen shows the Io 4K/XT software files that have been installed on your system. This information may be needed if you talk to an AJA Customer Service representative to determine if files are missing or need updating.

Using Io 4K for UltraHD/4K

This section describes the AJA Control Panel operations specific to Io 4K in 4K Mode. Note that in 4K Mode, you can still capture and playback SD, HD, and 2K formats, though there are no up/down/cross conversions available except for UltraHD/4K down conversion on the dedicated SDI monitor output.

4K/UltraHD Transport Modes

The 4K and UltraHD SDI formats can use different transport modes, associated with the number of links used to transport the signal, the data rates involved, and the way the image data is organized.

Io 4K in 4K Mode supports both Quadrant and Two Sample Interleave (2SI) transport standards. Many different combinations of modes and data organization exist.

Besides single link transport, Io 4K in 4K Mode also supports the following multiple link transport modes for UltraHD and 4K:

- Quadrant 4-wire (transported on four links)
- Quadrant 2-wire (transported on two links)
- 2SI (two or four links automatically selected)

The amount of data in the signal affects the number of links and data rates necessary to carry that signal.

Quadrant Mode

In Quadrant Mode you can use four HD or 2K signals (1.5G) to input / output UltraHD or 4K at 30fps or below, or four 3G signals to enable HFR and / or deep color. Whether using four 1.5G or four 3G wires, each represents individual quadrants of the higher definition UltraHD 3840x2160 or 4K 4096x2160 4K formats. Physical connections of the quadrants will be mapped to the SDI connectors as shown. Monitoring one of these HD signals on a standard SDI monitor will display one quadrant of the picture.

Figure 14. Mapping of Quad SDI Outputs



2SI Mode

Two Sample Interleave is an alternative method to organize the data of SDI UltraHD and 4K formats. Instead of dividing the picture raster into quadrants, this method samples pixels to create four lower resolution versions of the entire picture. These are combined later to create the full resolution image.

Figure 15. Mapping of 2SI Outputs



For 2SI UltraHD or 4K SDI video at 30 fps or less, monitoring one of these four signals on a standard SDI monitor displays the entire picture, but at a lower resolution. Above 30 fps, 3G bandwidth is required, so a 3G capable monitor is required.”

NOTE: In some versions of AJA Control Panel, the 2SI method is referred to as '425' which is a reference to the SMPTE 425 standard which defines this method.

2-Wire and 4-Wire Modes

Using higher data rates, it is possible to carry UltraHD and 4K signals on two SDI links, instead of four. In this situation, half (two quarters) of the image data is carried on one link, with the other half carried on the other link. These types of signals also cannot be viewed on a standard SDI monitor using one connector.

You can choose 2-wire or 4-wire input and output (depending on the type of signal). If the number of links selected is not sufficient, the number of links is automatically increased to accommodate the signal. UltraHD or 4K SDI signals 30 fps and below can be input and output simultaneously, using two connectors in each direction. However, all four connectors are required above 30 fps. You will be able to either input or output a high frame rate SDI signal, not both at the same

time. In this situation, you can use the down-converted SDI monitor output to monitor the input signal, or use the HDMI output. Note that to monitor incoming UltraHD/4K SDI as HDMI UltraHD/4K, the SDI input transport must be 2SI. Quad SDI will be down-converted to HD on the HDMI output.

Specifying the number of wires for output forces Quadrant mode. You cannot specify the number of links when 2SI output is selected (the lowest number of links will be set automatically).

Io 4K in 4K Mode Audio Monitoring

Io 4K in 4K Mode can be used as your single audio monitoring solution whether you are auditioning music in a web browser, playing a movie file on the desktop, creating music, or playing a YouTube clip. As long as the output of your work or application is normally output via the host system audio, your AJA hardware can route this audio for monitoring. This cuts down on unnecessary cabling, and means you can take advantage of a consistent audio monitoring environment whatever you are currently doing with your host system.

NOTE: On first use, you will need to tell your operating system to use AJA hardware as the default Input and Output hardware.

Io 4K lets you listen to Host System audio concurrently with your NLE audio. This is useful if you need to audition music tracks against playback of your NLE timeline, or if you need to Skype with a remote producer during an edit session, or for a myriad of other reasons.

You can also listen to Io 4K Input concurrently with your NLE (with the exception of Avid Media Composer). This is useful if you need to listen out for the readiness of talent, or the presence of some other feed, whilst you continue to work.

Io 4K in 4K Mode audio monitoring is routed and mixed using the Control Panel application's Audio Mixer screen. You can select sources to be monitored, and can adjust their levels. If you are using the 1/4 inch monitor output connector, an additional overall mix gain control is conveniently available on the Io 4K/XT's front panel.

The mixed audio monitor signal is also routed to:

- SDI Audio out
- HDMI Audio Out
- Analog Audio Out (via DB25 cable)

IMPORTANT: Even though you can hear changes in the signals and levels adjusted with the Audio Mixer screen, these changes are NOT recorded to disk during NLE Capture or Audio Punch In / Voice Over to Timeline. The Audio Mixer screen is dedicated for monitoring only, not program mixing.

Figure 16. lo 4K in 4K Mode Audio Monitoring Routing Diagram

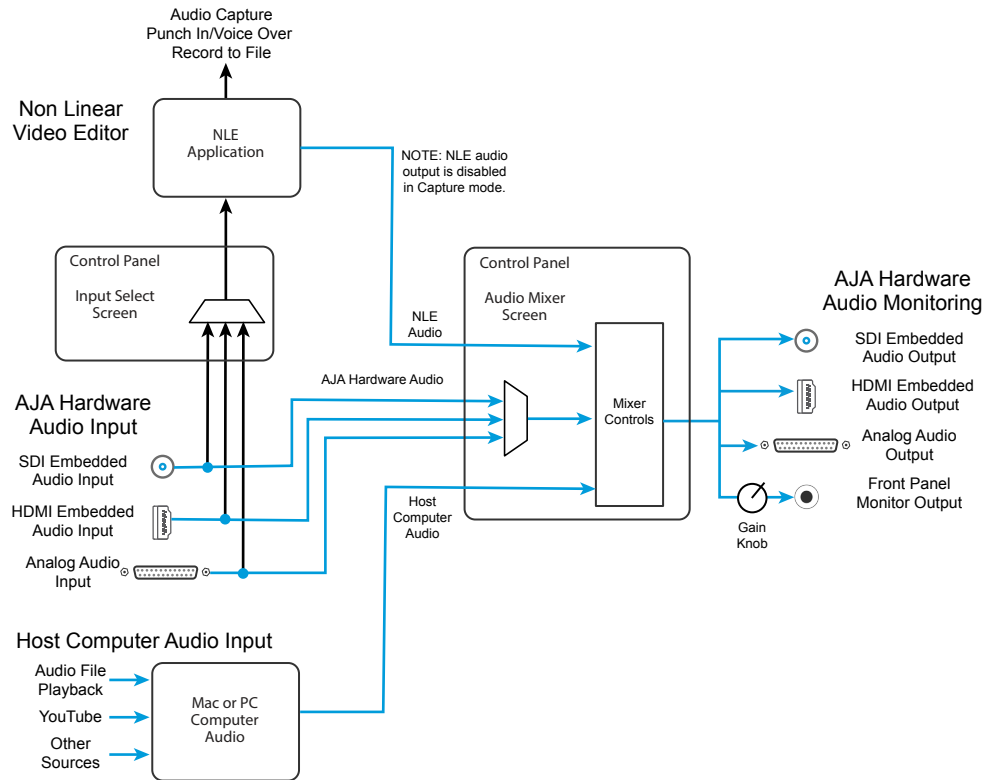

NOTE: Linux OS has not yet been tested with this functionality and as such remains unsupported until a future announcement.

To control which AJA hardware audio is used during recording, you use the Control Panel application's Input Select Screen, Audio Input Select drop down to select from

- SDI embedded
- HDMI embedded
- Analog (via DB25 cable)

Any level adjustments to Capture or Audio Punch In / Voice Over to Timeline recording operations will either need to be made upstream of the AJA input, or else via adjustments within the main NLE application (e.g. via a pass through mix tool).

lo 4K Control Panel Screen Differences in 4K Mode

The lo 4K in 4K Mode Control Panel screens that are significantly different from the lo XT screens previously described are presented below.

lo 4K Control Screen in 4K Mode

Besides SD, HD, and 2K input and output, 4K mode permits UltraHD or 4K input and/or output over 2 or 4 links.

For example, setting the Control Screen Default Video Output to Input Passthrough with a UltraHD 29.97 four link input connected, and selecting UltraHD/4K 4-wire Source on the Input Select menu, four connectors are used receive the signal to process. UltraHD signals report their links as 1080. No SDI BNC output connectors are available for use (Figure 17).

Figure 17. Control Screen with UltraHD 4 Link Input

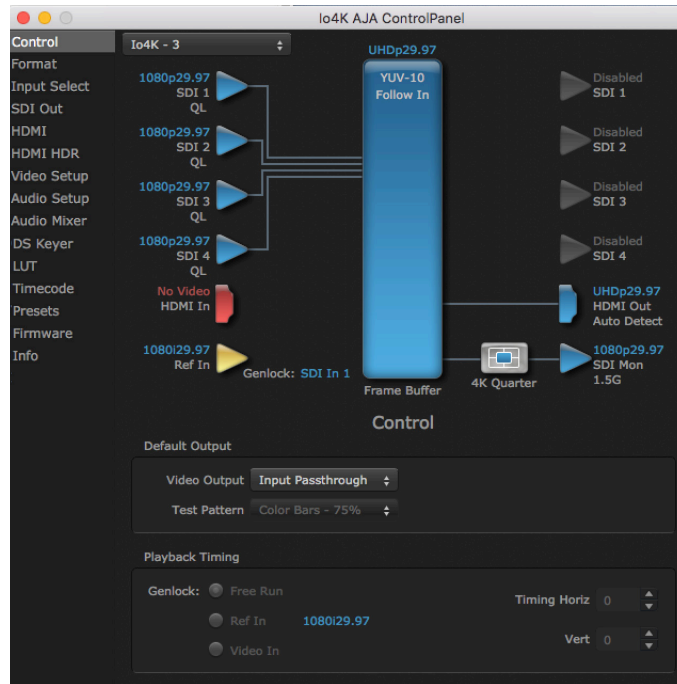

If a 4K 29.97 two link input is connected and a UltraHD/4K 2-wire Source is selected on the Input Select menu, two BNC connectors are used for input, allowing the other two to be used for SID output. 4K signals report their links as 2K (Figure 18).

Figure 18. Control Screen with 4K 2 Link Input and Output

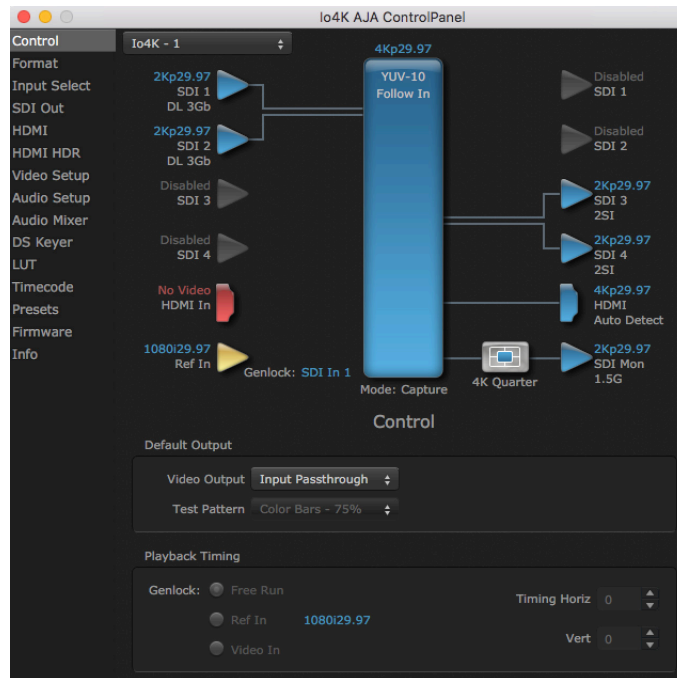

Io 4K Format Screen in 4K Mode

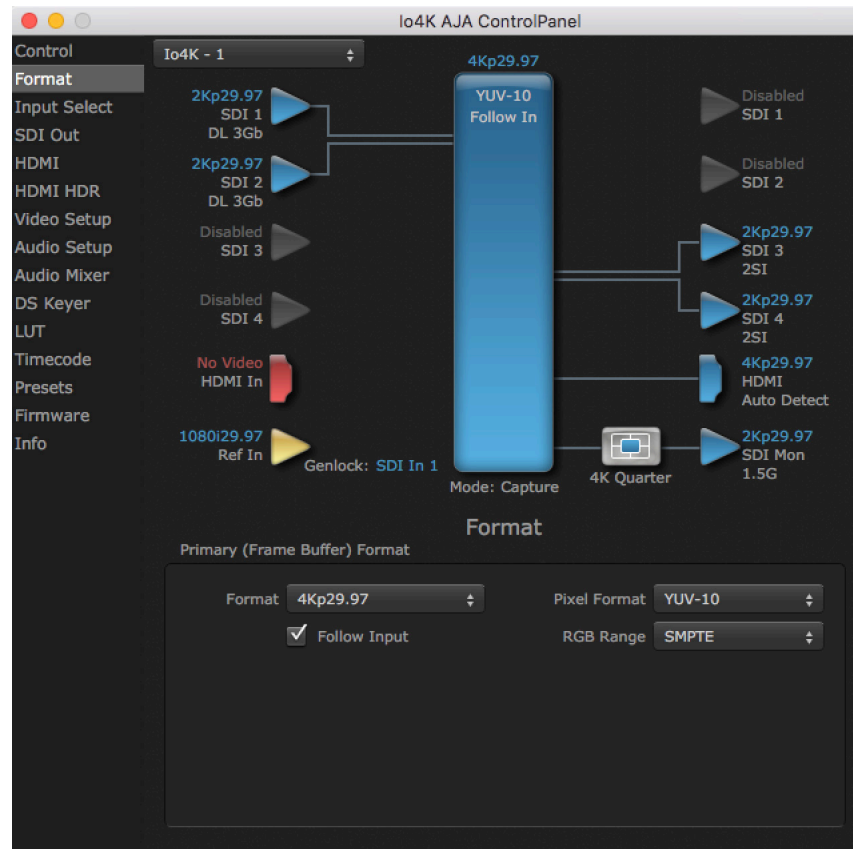

In 4K Mode the Io 4K Format Screen is the same as Io XT (see ["Format Screen" on page 25](#)) except a Secondary format is not available. In 4K Mode conversion is not supported, except the SDI Monitor Output that automatically down converts UltraHD to HD and 4K to 2K on just that output.

Io 4K Input Select Screen in 4K Mode

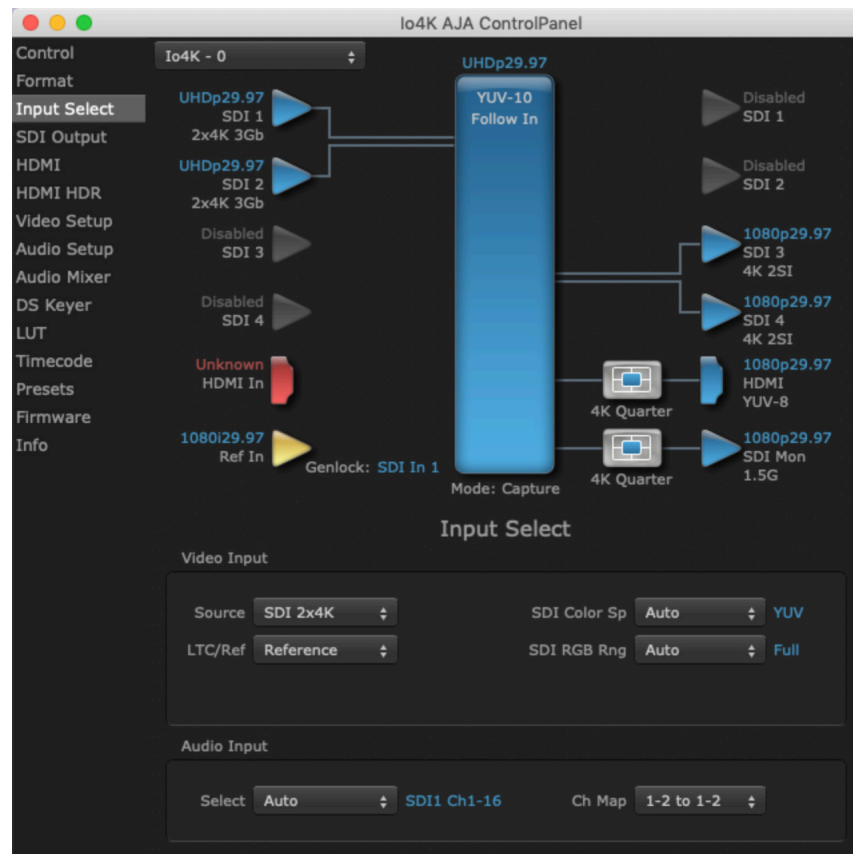

In 4K Mode the Io 4K Format Screen operates the same as Io XT (see ["Input Select Screen" on page 27](#)) except additional source video formats are available:

Source

The Source pulldown menu allows you to see and change what's currently selected and shows the video format that Io 4K/XT has detected (if any). To select a different input use the pulldown to choose from:

- SDI 1, SDI 2, SDI 2xHD, SDI 2x4K, SDI 4x4K, or HDMI

Io 4K SDI Output Screen in 4K Mode

Figure 19. SDI Output Screen with 4K Format

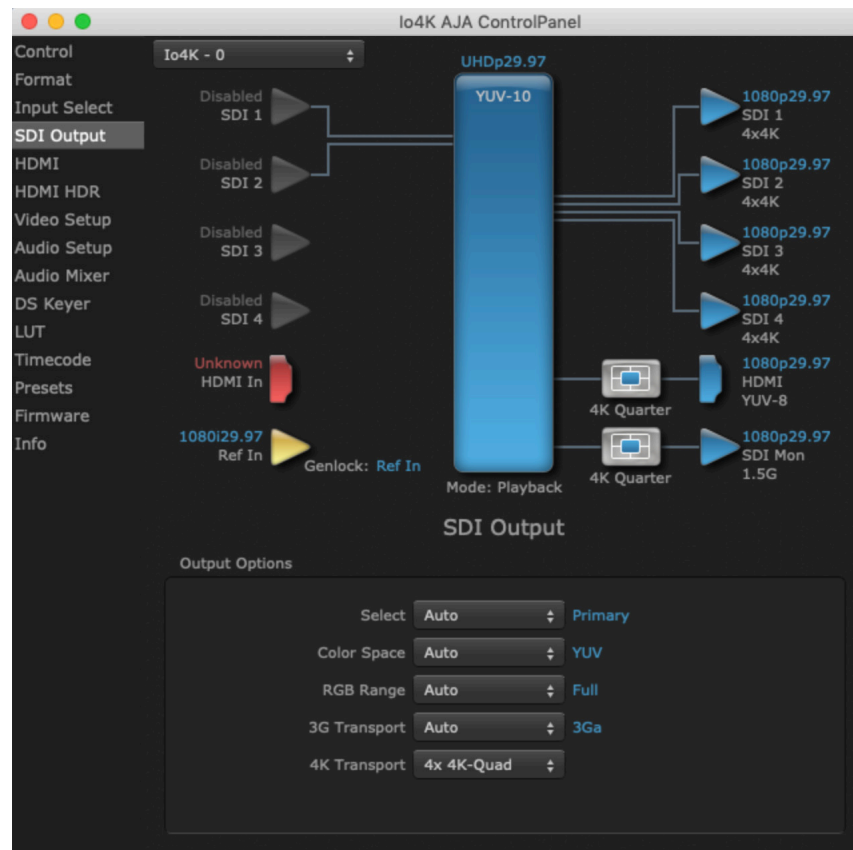

The SDI Output Screen has additional 4K related settings in 4K mode.

4K Transport

Select from:

- Auto
- 4K-2SI
- SDI 2x4K-Quad
- SDI 4x4K-Quad

NOTE: The 4K Transport setting also affects the IO 4K HDMI output signal, even if the SDI inputs are not being used. A SMPTE 2SI setting is required for UltraHD/4K HDMI output. Other 4K Transport settings will downconvert HDMI output to HD or 2K.

Io 4K HDMI Screen in 4K Mode

Figure 20. HDMI Output Screen with Quad HD Output Configuration



The HDMI screen allows you to make the same selections previously described for Standard Mode when an SD, HD, or 2K format is selected.

For UltraHD/4K formats, an HDMI monitor output Select menu is available to choose:

- Primary – the full 4K or UltraHD format
- 4K Quarter – a downconversion to 2K x 1080 in 4K or 1920 x 1080 for UltraHD.

Io 4K HDMI HDR Screen in 4K Mode

Figure 21. HDMI HDR Screen with 4K Primary Format

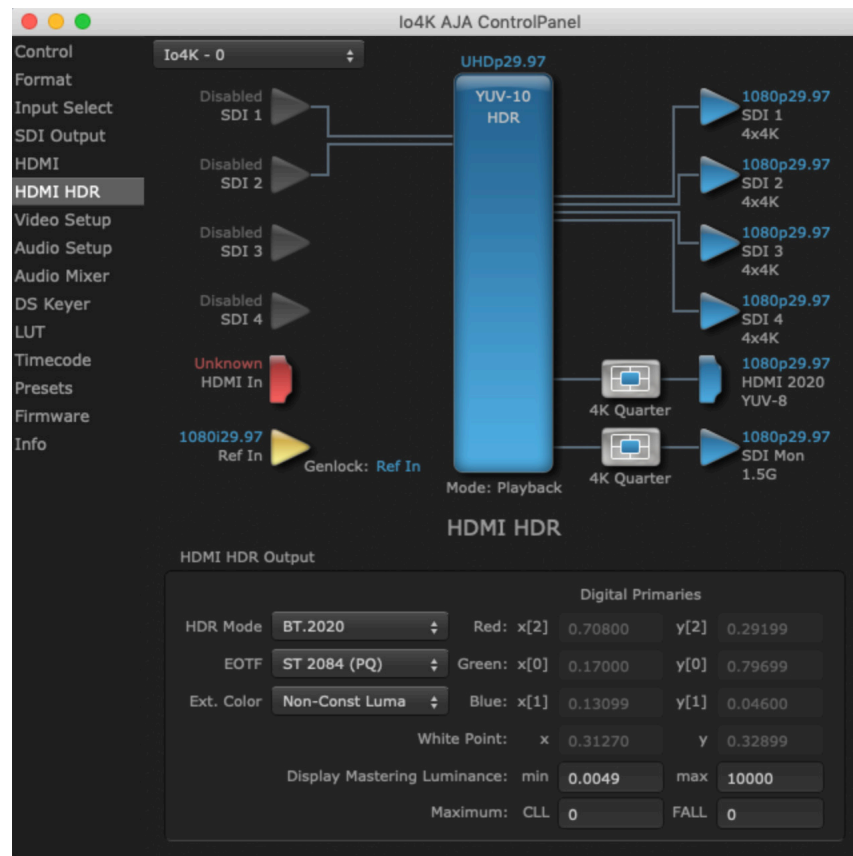

The HDMI-HDR screen, only available in 4K Mode, provides a mechanism to inform an HDMI sink device (such as a TV or monitor) that the video content is HDR. This includes generation of the Dynamic Range and Mastering Infoframe and the static metadata descriptors as defined in CTA-861.3 and HDMI v2.0a. Included are pre-canned primaries values for BT.2020 and DCI P3 color gamuts.

HDR Mode

- Off - HDR Mode disabled (default).
- DCI-P3 D65 - Only Display Mastering Luminance available for Digital Primaries.
- BT.2020 - Typically used with HDR.
- Custom - Allows custom values for the Digital Primaries.

EOTF

The Electrical Optical Transfer Function metadata bit tells the HDMI display which EOTF to use. Most TV's will require this to be set to ST 2084 for their HDR modes.

- Trad Gamma SD
- Trad Gamma HD
- ST 2084 (HDR-10)
- HLG (Hybrid Log Gamma) - No meta-data for Digital Primaries.

Ext. Color

Most TV's require this be set to Non-Const Luma to go into their HDR modes.

Digital Primaries

Selecting Custom HDR Mode allows the editing of digital primaries information that is passed as metadata accompanying the video signal. However, when HLG selected as the EOTF digital primaries information cannot be edited, because HLG does not use metadata.

Display Mastering Luminance

Represents the minimum and maximum Display Mastering Luminance.

- **Minimum:** Defines the floor of the SMPTE ST 2086 color volume (in the case of HDR) and is determined by the mastering environment.
 - Range: 0.00000 cd/m² to 1.00000 cd/m².
 - Step size: 0.00002 cd/m².
- **Maximum:** Defines the ceiling of the SMPTE ST 2086 color volume (in the case of HDR) and is determined by the mastering environment.
 - Range: 1 cd/m² to 65535 cd/m².
 - Step size: 1 cd/m².

Maximum Content Light Level (CLL)

Represents the highest-value pixel component in an entire scene. It is determined by analyzing each frame of video, and can be determined in the post environment.

- Range: 1 cd/m² to 65535 cd/m².
- Step size: 1 cd/m².

Maximum Frame Average Light Level (FALL)

Represents the maximum of frame-based average light levels taken over an entire scene, and can be determined in the post environment.

- Range: 1 cd/m² to 65535 cd/m².
- Step size: 1 cd/m².

Io 4K Video Setup Screen in 4K Mode

Figure 22. QuickTime Video Output Filter 4K Geometry Checkbox

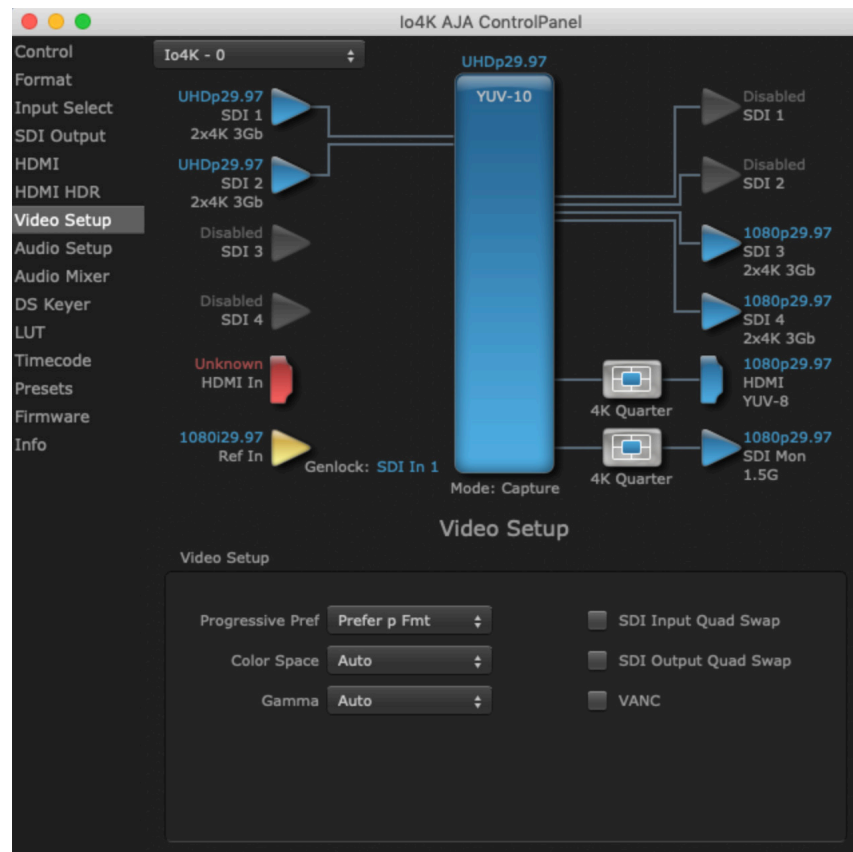

4K Mode adds Quad Swap controls to the Video Setup Screen.

SDI Input Quad Swap

- When checked (default setting is Off), changes the input Quad to SDI quadrant mapping from 1 to 1 to:
 - Quad1 - SDI3
 - Quad2 - SDI4
 - Quad3 - SDI1
 - Quad4 - SDI2.

SDI Output Quad Swap

- When checked (default setting is Off), changes the output Quad to SDI quadrant mapping from 1 to 1 to the mapping shown above.

Automatic 4-Link to 2-Link Switching

You can use Quad Swap settings to automatically switch Io4K 4K operation from 4-Link to 2-Link transport, without the need to repatch Io4K BNCs for each transport change. This can be useful if, for example, you want to connect Io4K's outputs to an SDI monitor that sometimes views 4-Link 4K/UltraHD inputs, and sometimes views 2-Link or Single-Link HD inputs. All that is required is to re-orient Io4K's output BNC connectors once, and turn on SDI Output Quad Swap.

Auto Link Switching Configuration Example

For 4K/UHD monitoring (Frame Buffer set to 4K raster – transport set to 4x 4K):

1. Connect the lo4K output SDI BNCs in the following manner:

- lo4K SDI 1 Output -> to -> Monitor SDI 3 Input
- lo4K SDI 2 Output -> to -> Monitor SDI 4 Input
- lo4K SDI 3 Output -> to -> Monitor SDI 1 Input
- lo4K SDI 4 Output -> to -> Monitor SDI 2 Input

At this time when you view 4K/UHD over the 4x 3G-SDI links on the monitor, the quadrants will not be displayed correctly.

2. Enable the Control Panel “SDI Output Quad swap” feature. Now the 4K/UHD monitor will display the quadrants correctly.

To make the monitor display a single or dual link 2K/HD RGB or YUV output, simply set the lo4K framebuffer to 2K Raster and the transport to 2xHD-DL. With the settings above, lo4K will automatically change its outputs to SDI 3 and SDI 4, and the monitor will display the 2K/HD image correctly, and vice versa.

The reverse function is also possible, using “SDI Input Quad swap”, allowing swapping back and forth between quad 4K input and dual link 2K input without having to re-patch.

lo 4K Audio Mixer Screens (4K Mode only)

The Audio Mixer screen lets you control Playback and Capture audio sources (if the application supports capture), and also mix that audio. Two screens are available, selected by clicking on the Playback Monitor or Capture Monitor tabs. Controls in each tab are only in effect when lo 4K/XT is in the correct operating mode. When the mode doesn't match, the mode indicator on the right goes red. However, settings can be adjusted in that incorrect mode, and will be applied when you select the other operating screen.

The branching arrow on the right indicates which sources are being routed in that operating mode, and is colored blue when active and red when disabled.

Playback Monitor Mode (4K Mode only)

Figure 23. Audio Mixer Screen, Playback Monitor Mode

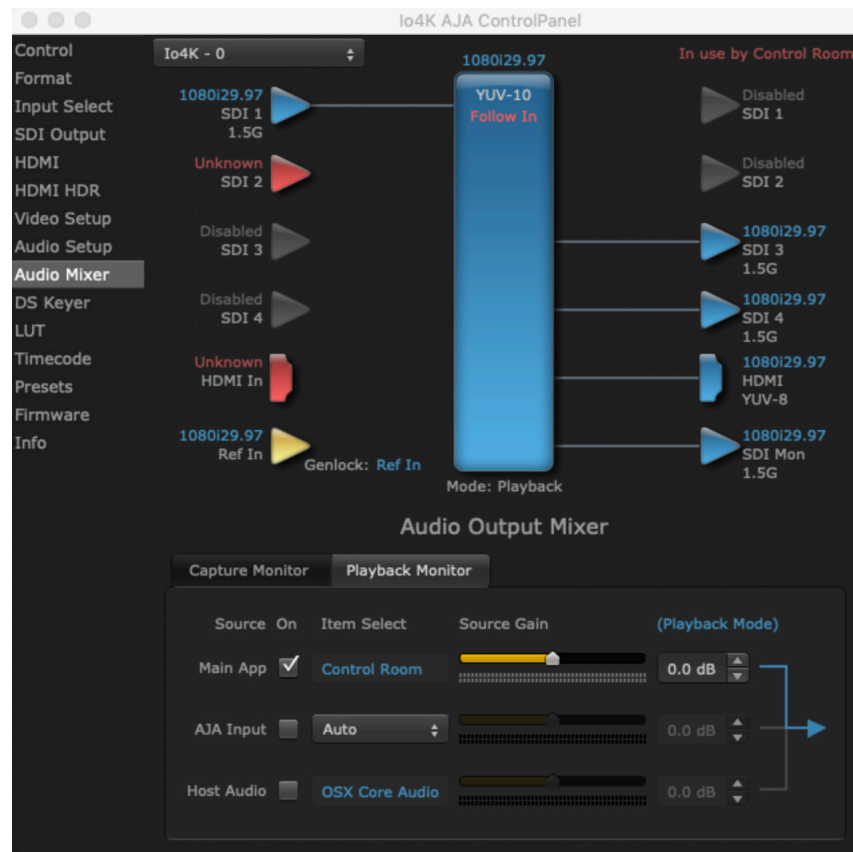

Playback Source Selection

Clicking the **On** checkbox selects the audio for that item for playback to the audio monitor outputs. Multiple sources can be selected.

Main App

If an external application is controlling the lo 4K/XT, it will be displayed in the **Item Select** column and its audio can be selected for playback with the checkbox.

AJA Input

Selects for monitor playback the audio being input to lo 4K/XT.

NOTE: The AJA Input Item Select dropdown selection is linked to the Input Select screen's Audio Input Select dropdown. Changing the setting on one screen will also change the setting on the other screen.

In the **Item Select** column, click on the dropdown and choose from:

- HDMI - The audio being received the lo 4K/XT HDMI In connector.
- SDI Ch 1-16 - The embedded audio being received on the lo 4K/XT SDI In connectors.

Host Audio

Selects the audio from the host computer. For example, you can playback audio from a loaded session if the computer is configured to playback that audio.

Source Gain

Meters display the audio levels of the source, colored green when that source is On, and gray when that source is not selected.

When activated, the source gain sliders can be used to adjust the output gain of that source, from +3db to -3db.

- Sliders - The sliders on the right can be used to change the values for each color.
- Numeric Entry - You also enter a numeric value by clicking on the displayed number, and can increase or decrease the values clicking on the up/down arrow boxes.
- Cut and Paste - Right clicking on a displayed number opens a Cut, Copy, Paste dropdown menu for convenient numeric entry.

Io 4K Downstream Keyer in 4K Mode

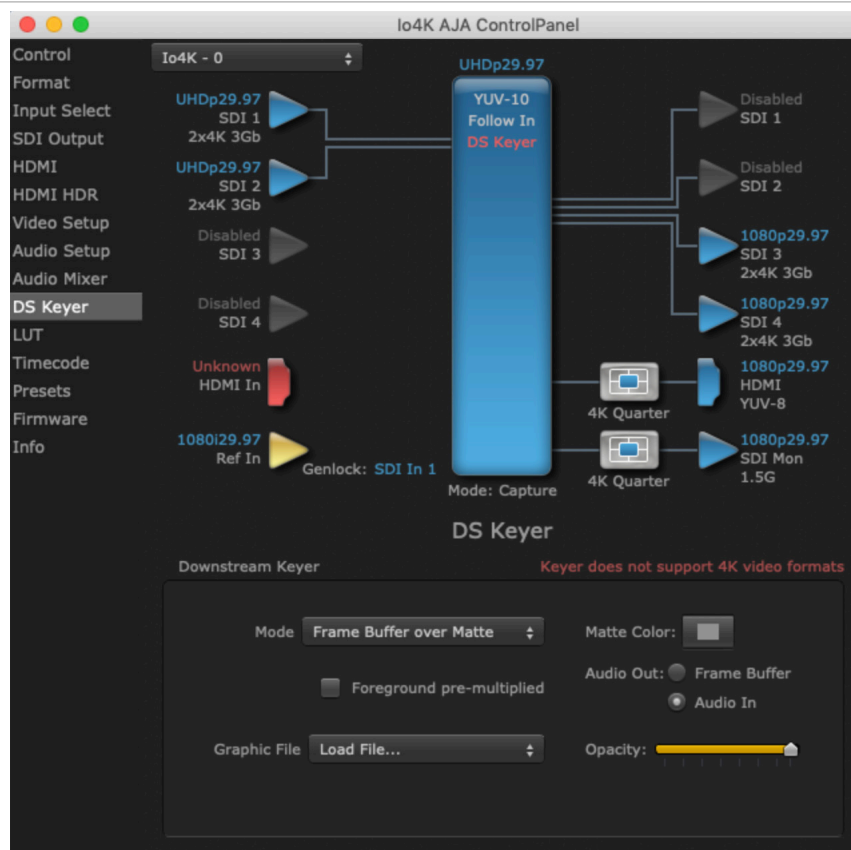

The Downstream Keyer does not support UltraHD/4K formats, but is available for use with other video formats. If this screen is selected with a UltraHD/4K format configured, a "Keyer does not support 4K video formats" message will be displayed.

Appendix A – Specifications

Io 4K Tech Specs

Video Formats

- (4K) 4096 x 2160p 23.98, 24, 25, 29.97, 30, 50, 59.94, 60
- (UltraHD) 3840 x 2160p 23.98, 24, 25, 29.97, 30, 50, 59.94, 60
- (2K) 2048 x 1080p 23.98, 24, 25, 29.97, 30, 50, 59.94, 60
- (2K) 2048 x 1080PsF 23.98, 24, 25, 29.97, 30
- (HD) 1080i 50, 59.94, 60
- (HD) 1080PsF 23.98, 24, 25, 29.97, 30
- (HD) 1080p 23.98, 24, 25, 29.97, 30, 50, 59.94, 60
- (HD) 720p 50, 59.94, 60
- (SD) 625i 50
- (SD) 525i 59.94

Note: High Frame Rate support is dependent on Thunderbolt speed. Not all systems will support all frame rates.

Video Inputs

- 3G-SDI, SMPTE-259/292/296/424/425, 8-bit, 10-bit and 12-bit*
- 4K/UltraHD 4:4:4 (4x BNC)
- 2K HSDL (High Speed Data Link) 4:4:4 (2x BNC)
- Dual Link HD 4:4:4 (2 x BNC)
- Single Link 4:2:2 or 4:4:4 (1x BNC)
- HDMI v1.4
 - 30/36 bits/pixel, RGB or YUV, 2.25 Gbps.
 - UltraHD, 2K, HD and SD

*NOTE: Bit depth support is application dependent. Check with your software manufacturer for compatibility.

Video Outputs

- 3G-SDI, SMPTE-259/292/296/424, 8-bit, 10-bit and 12-bit*
- 4K/UltraHD 4:4:4 (4x BNC)
- 2K HSDL (High Speed Data Link) 4:4:4 (2x BNC)
- Dual Link HD 4:4:4 (2x BNC)
- Single Link 4:2:2 or 4:4:4 (1x BNC)
- HDMI v1.4b
 - 30/36 bits/pixel, RGB or YUV, 2.25 Gbps
 - 2K, HD, and SD, UltraHD with HFR support up to 60p 4:2:0
 - HDR10 Support - HDR Infoframe metadata, in accordance with HDMI 2.0a/CTA-861.3
 - HLG Support - in accordance with HDMI 2.0b/CTA-861-G**

*NOTE: Bit depth support is application dependent. Check with your software manufacturer for compatibility.

**HLG support is application dependent. Check with your software manufacturer for compatibility.

Audio Inputs Digital

- 16-Channel, 24-bit SDI embedded audio, 48 kHz sample rate, synchronous
- 8-Channel, 24-bit HDMI embedded audio, 48 kHz sample rate, synchronous

Audio Outputs Digital

- 16-Channel, 24-bit SDI embedded audio, 48 kHz sample rate, synchronous
- 8-Channel, 24-bit HDMI embedded audio, 48 kHz sample rate, synchronous

Audio Outputs Analog

- 8-Channel, 24-bit D/A analog audio, 48 kHz sample rate, balanced, using industry standard 8 x XLR on DB-25 breakout cable (Breakout cable NOT included)
- +24 dbu full scale digital (0dbFS)
- +/- 0.2 db 20 to 20 kHz frequency response

Downstream Keyer

- Supports graphics with alpha channel over video, matte or framebuffer, or framebuffer content over incoming video or matte

Down-Conversion 4K/UltraHD

- Realtime, dedicated 4K down-conversion output (1x BNC)
- 4K to 2K down-conversion
- UltraHD to HD down-conversion

Reference and LTC I/O

- 1 x BNC LTC output
- 1 x BNC assignable to Reference video or LTC input

Reference

- Analog Color Black (1V) or Composite Sync (2 or 4V)
- Nonterminating

Electrical Interface

- Thunderbolt 2 (2x)

Machine Control

- RS-422, Sony 9-pin protocol
- 9-pin D-connector pinout is as follows:

Shell GND

1 GND

2 RX-

3 TX+

4 GND

5 No Connection

6 GND

7 RX+

8 TX-

9 GND

Shell GND

Size (w x d x h)

- 8.74" x 7.09" x 1.65" (222mm x 180mm x 42mm)

Weight

- 3.1 lbs (1.5 kg)

Power

- 10-20V, 23W typical, 28W max

Environment

- Safe Operating Temperature Range: 0 to 35C (32F to 95F)
- Safe Storage Temperature (Power OFF): -40 to 60 degrees C (-40 to 140 degrees F)
- Operating Relative Humidity: 10-90% noncondensing
- Operating Altitude: <3,000 meters (<10,000 feet)

Io XT Tech Specs

Video Formats

- (2K) 1080p 23.98, 24, 25
- (2K) 1080PsF 23.98, 24, 25
- (HD) 1080i 50, 59.94, 60
- (HD) 1080PsF 23.98, 24, 25, 29.97, 30
- (HD) 1080p 23.98, 24, 25, 29.97, 30, 50, 59.94, 60
- (HD) 720p 23.98*, 24*, 25*, 29.97*, 30*, 50, 59.94, 60
- (SD) 625i 50
- (SD) 525i 23.98*, 59.94

*These formats are dependent on specific software functionality and are not normal over the wire formats

Video Input Digital

- 3G-SDI, SMPTE-259/292/296/424, 10-bits
- Dual Link HD 4:4:4, (2x BNC)
- Single Link 4:2:2 or 4:4:4 (1x 3G BNC)
- HDMI v1.3
- 1D LUT Support (Mac and PC)

Video Output Digital

- 3G-SDI, SMPTE-259/292/296/424
- Dual Link HD 4:4:4, (2x BNC)
- Single Link 4:2:2 or 4:4:4 (1x BNC)
- HDMI v1.4, 30/36 bits/pixel, RGB or YUV, 2.25 Gbps

Video Output Analog

- Composite/S-Video (Y/C) (1x BNC/2x BNC+adapter)
- NTSC, NTSCJ, PAL
- Component (3x BNC)
- HD: YPbPr, RGB
- SD: YPbPr, RGB (component mode)
- SMPTE/EBU N10, Betacam 525 line, Betacam 525J, RGB
- 12-bit D/A, 8x oversampling
- +/- .2 dB to 5.0 MHz Y Frequency Response
- +/- .2 dB to 1 MHz C Frequency Response
- .5% 2T pulse response
- <1% Diff Phase
- <1% Diff Gain
- <1 ns Y/C delay inequity

Audio Input Digital

- 16-Channel, 24-bit SMPTE-259 SDI embedded audio, 48 kHz sample rate, synchronous
- 8-Channel, 24-bit HDMI embedded audio, 48 kHz sample rate, synchronous

Audio Output Digital

- 16-Channel, 24-bit SMPTE-259 SDI embedded audio, 48 kHz sample rate, synchronous
- 8-Channel, 24-bit HDMI embedded audio, 48 kHz sample rate, synchronous

Audio Output Analog

- 8-Channel, 24-bit D/A analog audio, 48 kHz sample rate, balanced, using industry standard 8 x XLR on DB-25 breakout cable (Breakout cable NOT included)
- +24dbu Full Scale Digital (0dbFS)
- +/- 0.2db 20 to 20 kHz frequency response

Downstream Keyer

- Supports graphics with alpha channel over video, matte or framebuffer, or framebuffer content over incoming video or matte

Up-conversion

- Hardware 10-bit
- Anamorphic: fullscreen
- Pillarbox 4:3: results in a 4:3 image in center of screen with black sidebars
- Zoom 14:9: results in a 4:3 image zoomed slightly to fill a 14:9 image with black side bars
- Zoom Letterbox: results in image zoomed to fill full screen
- Zoom Wide: results in a combination of zoom and horizontal stretch to fill a 16:9 screen; this setting can introduce a small aspect ratio change

Down-conversion

- Hardware 10-bit
- Anamorphic: full-screen
- Letterbox: image is reduced with black top and bottom added to image area with the aspect ratio preserved
- Crop: image is cropped to fit new screen size

Cross-conversion

- Hardware 10-bit
- 1080i to 720p
- 720p to 1080i
- 720p to 1080PsF

SD to SD aspect ratio conversion

- Letterbox: This transforms SD anamorphic material to a letterboxed image
- H Crop: Will produce a horizontally stretched effect on the image; transforms anamorphic SD to full frame
- SD Pillarbox: Will produce an image in the center of the screen with black borders on the left and right sides and an anamorphized image in the center
- V Crop: Will transform SD letterbox material to an anamorphic image

Reference Input or LTC Input

- 1x BNC assignable to Reference video or LTC input

Reference

- Analog Color Black (1V) or Composite Sync (2 or 4V)
- Nonterminating

Electrical Interface

- Thunderbolt 1 (2x)

Machine Control

- RS-422, Sony 9-pin protocol
- 9-pin D-connector pinout is as follows:
 - 1 GND
 - 2 RX-
 - 3 TX+
 - 4 GND
 - 5 No Connection
 - 6 GND
 - 7 RX+
 - 8 TX-
 - 9 GND
- Shell GND

Size (w x d x h)

- 8.74" x 7.09" x 1.65" (222mm x 180mm x 42mm)

Weight

- 1.75 lbs (0.9 kg)

Power

- 10-20V, 18W typical, 22W max

Environment

- Safe Operating Temperature: 0 to 40 degrees C (32 to 104 degrees F)
- Safe Storage Temperature (Power OFF): -40 to 60 degrees C (-40 to 140 degrees F)
- Operating Relative Humidity: 10-90% noncondensing
- Operating Altitude: <3,000 meters (<10,000 feet)

Audio Connection Pinouts

Analog Audio

Figure 24. DB-25 Analog Audio Connector Pinouts

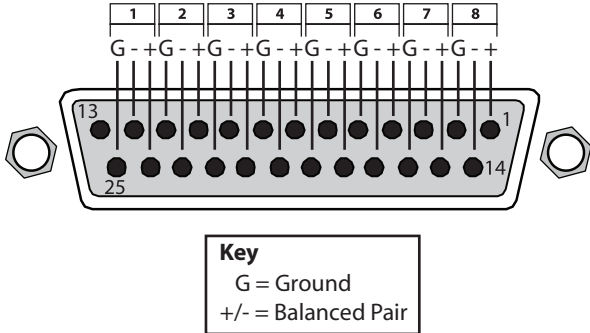

Appendix B – Safety and Compliance

Federal Communications Commission (FCC) Compliance Notices

Class A Interference Statement

This equipment has been tested and found to comply with the limits for a Class A digital device, pursuant to Part 15, Subpart B of the FCC Rules. These limits are designed to provide reasonable protection against harmful interference in a residential installation. This equipment generates, uses, and can radiate radio frequency energy and, if not installed and used in accordance with the instructions, may cause harmful interference to radio communications. However, there is no guarantee that interference will not occur in a particular installation. If this equipment does cause harmful interference to radio or television reception, which can be determined by turning the equipment off and on, the user is encouraged to try to correct the interference by one or more of the following measures:

- Reorient or relocate the receiving antenna.
- Increase the separation between the equipment and receiver.
- Connect the equipment into an outlet on a circuit different from that to which the receiver is connected.
- Consult the dealer or an experienced radio/TV technician for help.

FCC Caution

This device complies with Part 15 of the FCC Rules. Operation is subject to the following two conditions: (1) This device may not cause harmful interference, and (2) this device must accept any interference received, including interference that may cause undesired operation.

Canadian ICES Statement

Canadian Department of Communications Radio Interference Regulations

This digital apparatus does not exceed the Class A limits for radio-noise emissions from a digital apparatus as set out in the Radio Interference Regulations of the Canadian Department of Communications. This Class A digital apparatus complies with Canadian ICES-003.

Règlement sur le brouillage radioélectrique du ministère des Communications

Cet appareil numérique respecte les limites de bruits radioélectriques visant les appareils numériques de classe A prescrites dans le Règlement sur le brouillage radioélectrique du ministère des Communications du Canada. Cet appareil numérique de la Classe A est conforme à la norme NMB-003 du Canada.

European Union and European Free Trade Association (EFTA) Regulatory Compliance

This equipment may be operated in the countries that comprise the member countries of the European Union and the European Free Trade Association. These countries, listed in the following paragraph, are referred to as The European Community throughout this document:

AUSTRIA, BELGIUM, BULGARIA, CYPRUS, CZECH REPUBLIC, DENMARK, ESTONIA, FINLAND, FRANCE, GERMANY, GREECE, HUNGARY, IRELAND, ITALY, LATVIA, LITHUANIA, LUXEMBOURG, MALTA, NETHERLANDS, POLAND, PORTUGAL, ROMANIA, SLOVAKIA, SLOVENIA, SPAIN, SWEDEN, UNITED KINGDOM, ICELAND, LICHTENSTEIN, NORWAY, SWITZERLAND

Declaration of Conformity

Marking by this symbol indicates compliance with the Essential Requirements of the EMC Directive of the European Union 2014/30/EU.



This equipment meets the following conformance standards:

Safety

EN 60065: 2014 (T-Mark License),

IEC 60065: 2014, (CB Scheme Report/Certificate)

Additional licenses issued for specific countries available on request.

Emissions

EN 55032: 2012 + AC: 2013, CISPR 32: 2015

EN 61000-3-2: 2014, EN 61000-3-3: 2013

Immunity

EN 55103-2: 2009

61000-4-2: 2009, EN 61000-4-3: 2006 + A1: 2008 + A2: 2010,

EN 61000-4-4: 2004 + A1: 2010, EN 61000-4-5: 2006,

EN 61000-4-6: 2009, EN 61000-4-11: 2004

Environments: E2, E3 and E4

The product is also licensed for additional country specific standards as required for the International Marketplace.



Warning! This is a Class A product. In a domestic environment, this product may cause radio interference, in which case, the user may be required to take appropriate measures.

Achtung! Dieses ist ein Gerät der Funkstörgrenzwertklasse A. In Wohnbereichen können bei Betrieb dieses Gerätes Rundfunkstörungen auftreten, in welchen Fällen der Benutzer für entsprechende Gegenmaßnahmen verantwortlich ist.

Attention! Ceci est un produit de Classe A. Dans un environnement domestique, ce produit risque de créer des interférences radioélectriques, il appartiendra alors à l'utilisateur de prendre les mesures spécifiques appropriées..

Recycling Notice



This symbol on the product or its packaging indicates that this product must not be disposed of with your other household waste. Instead, it is your responsibility to dispose of your waste equipment by handing it over to a designated collection point for the recycling of waste electrical and electronic equipment. The separate collection and recycling of your waste equipment at the time of disposal will help conserve natural resources and ensure that it is recycled in a manner that protects human health and the environment. For more information about where you can drop off your waste for recycling, please contact your local authority, or where you purchased your product.

Korea KCC Compliance Statement

<p>A급 기기 (업무용 방송통신기자재)</p>	<p>이 기기는 업무용(A급) 전자파적합기기로서 판매자 또는 사용자는 이 점을 주의하시기 바라며, 가정외의 지역에서 사용하는 것을 목적으로 합니다.</p>
<p>Class A (Broadcasting Communication Equipment for Office Use)</p>	<p>As an electromagnetic wave equipment for office use (Class A), this equipment is intended to use in other than home area. Sellers or users need to take note of this.</p>

Taiwan Compliance Statement

警告使用者：
這是甲類的資訊產品，在居住的環境中使用時，可能會造成射頻干擾，在這種情況下，使用者會被要求採取某些適當的對策。

This is a Class A product based on the standard of the Bureau of Standards, Metrology and Inspection (BSMI) CNS 13438, Class A. In a domestic environment this product may cause radio interference in which case the user may be required to take adequate measures.

Japan Compliance Statement

この装置は、クラスA情報技術装置です。この装置を家庭環境で使用すると電波妨害を引き起こすことがあります。この場合には使用者が適切な対策を講ずるよう要求されることがあります。 VCCI-A

This is a Class A product based on the standard of the VCCI Council (VCCI 32: 2016). If this equipment is used in a domestic environment, radio interference may occur, in which case, the user may be required to take corrective actions.

China Compliance Statement

This product has been tested to the following Chinese standards:

GB13837-2012, GB8898-2011, and GB17625.1-2012

This product meets the requirements of implementation rules for compulsory certification (REF NO. CNCA-01C-17:2010) under certificate numbers 2012010805541543 and 2014010805686912.

Translated Warning and Caution Messages

The following caution statements, warning conventions, and warning messages apply to this product and manual.



Warning Symbol



Caution Symbol

Before Operation Please Read These Instructions



Warning! Read and follow all warning notices and instructions marked on the product or included in the documentation.

Avertissement! Lisez et conformez-vous à tous les avis et instructions d'avertissement indiqués sur le produit ou dans la documentation.

Warnung! Lesen und befolgen Sie die Warnhinweise und Anweisungen, die auf dem Produkt angebracht oder in der Dokumentation enthalten sind.

¡Advertencia! Lea y siga todas las instrucciones y advertencias marcadas en el producto o incluidas en la documentación.

Aviso! Leia e siga todos os avisos e instruções assinalados no produto ou incluídos na documentação.

Avviso! Leggere e seguire tutti gli avvisi e le istruzioni presenti sul prodotto o inclusi nella documentazione.



Warning! Do not use this device near water and clean only with a dry cloth.

Avertissement! N'utilisez pas cet appareil près de l'eau et nettoyez-le seulement avec un tissu sec.

Warnung! Das Gerät nicht in der Nähe von Wasser verwenden und nur mit einem trockenen Tuch säubern.

¡Advertencia! No utilice este dispositivo cerca del agua y límpielo solamente con un paño seco.

Aviso! Não utilize este dispositivo perto da água e limpe-o somente com um pano seco.

Avviso! Non utilizzare questo dispositivo vicino all'acqua e pulirlo soltanto con un panno asciutto.



Warning! Do not block any ventilation openings. Install in accordance with the manufacturer's instructions.

Avertissement! Ne bloquez aucune ouverture de ventilation. Suivez les instructions du fabricant lors de l'installation.

Warnung! Die Lüftungsöffnungen dürfen nicht blockiert werden. Nur gemäß den Anweisungen des Herstellers installieren.

¡Advertencia! No bloquee ninguna de las aberturas de la ventilación. Instale de acuerdo con las instrucciones del fabricante.

Aviso! Não obstrua nenhuma das aberturas de ventilação. Instale de acordo com as instruções do fabricante.

Avviso! Non ostruire le aperture di ventilazione. Installare in conformità con le istruzioni del fornitore.



Warning! Do not install near any heat sources such as radiators, heat registers, stoves, or other apparatus (including amplifiers) that produce heat.

Avertissement! N'installez pas l'appareil près d'une source de chaleur telle que des radiateurs, des bouches d'air de chauffage, des fourneaux ou d'autres appareils (amplificateurs compris) qui produisent de la chaleur.

Warnung! Nicht in der Nähe von Wärmequellen wie Heizkörpern, Heizregistern, Öfen oder anderen Wärme erzeugenden Geräten (einschließlich Verstärkern) aufstellen.

¡Advertencia! No instale cerca de fuentes de calor tales como radiadores, registros de calor, estufas u otros aparatos (incluidos amplificadores) que generan calor.

Aviso! Não instale perto de nenhuma fonte de calor tal como radiadores, saídas de calor, fogões ou outros aparelhos (incluindo amplificadores) que produzam calor.

Avviso! Non installare vicino a fonti di calore come termosifoni, diffusori di aria calda, stufe o altri apparecchi (amplificatori compresi) che emettono calore



Warning! Unplug this device during lightning storms or when unused for long periods of time.

Avertissement! Débranchez cet appareil pendant les orages avec éclairs ou s'il est inutilisé pendant de longues périodes.

Warnung! Das Gerät ist bei Gewitterstürmen oder wenn es über lange Zeiträume ungenutzt bleibt vom Netz zu trennen.

¡Advertencia! Desenchufe este dispositivo durante tormentas eléctricas o cuando no se lo utilice por largos periodos del tiempo.

Aviso! Desconecte este dispositivo da tomada durante trovoadas ou quando não é utilizado durante longos períodos de tempo.

Avviso! Utilizzare soltanto i collegamenti e gli accessori specificati e/o venduti dal produttore, quali il treppiedi e l'esoscheletro.



Warning! Do not open the chassis. There are no user-serviceable parts inside. Opening the chassis will void the warranty unless performed by an AJA service center or licensed facility.

Avertissement! Ne pas ouvrir le châssis. Aucun élément à l'intérieur du châssis ne peut être réparé par l'utilisateur. La garantie sera annulée si le châssis est ouvert par toute autre personne qu'un technicien d'un centre de service ou d'un établissement agréé AJA.

Warnung! Öffnen Sie das Gehäuse nicht. Keine der Geräteteile können vom Benutzer gewartet werden. Durch das Öffnen des Gehäuses wird die Garantie hinfällig, es sei denn, solche Wartungsarbeiten werden in einem AJA-Service-Center oder einem lizenzierten Betrieb vorgenommen.

¡Advertencia! No abra el chasis. El interior no contiene piezas reparables por el usuario. El abrir el chasis anulará la garantía a menos que se lo haga en un centro de servicio AJA o en un local autorizado.

Advertência! Não abra o chassi. Não há internamente nenhuma peça que permita manutenção pelo usuário. Abrir o chassi anula a garantia, a menos que a abertura seja realizada por uma central de serviços da AJA ou por um local autorizado.

Avvertenza! Non aprire lo chassis. All'interno non ci sono parti riparabili dall'utente. L'apertura dello chassis invaliderà la garanzia se non viene effettuata da un centro ufficiale o autorizzato AJA.



Warning! Only use attachments and accessories specified and/or sold by the manufacturer.

Avertissement! Utilisez seulement les attaches et accessoires spécifiés et/ou vendus par le fabricant.

Warnung! Verwenden Sie nur Zusatzgeräte und Zubehör angegeben und / oder verkauft wurde durch den Hersteller.

¡Advertencia! Utilice solamente los accesorios y conexiones especificados y/o vendidos por el fabricante.

Aviso! Utilize apenas equipamentos/acessórios especificados e/ou vendidos pelo fabricante.

Avviso! Utilizzare soltanto i collegamenti e gli accessori specificati e/o venduti dal produttore.



Warning! Refer all servicing to qualified service personnel. Servicing is required when the device has been damaged in any way, such as power-supply cord or plug is damaged, liquid has been spilled or objects have fallen into the device, the device has been exposed to rain or moisture, does not operate normally, or has been dropped.

Avertissement! Référez-vous au personnel de service qualifié pour tout entretien. L'entretien est exigé quand l'appareil a été endommagé de quelque manière que ce soit, par exemple lorsque le cordon d'alimentation ou la prise sont endommagés, que du liquide a été versé ou des objets sont tombés dans l'appareil, que l'appareil a été exposé à la pluie ou à l'humidité, ne fonctionne pas normalement ou est tombé.

Warnung! Das Gerät sollte nur von qualifizierten Fachkräften gewartet werden. Eine Wartung ist fällig, wenn das Gerät in irgendeiner Weise beschädigt wurde, wie bei beschädigtem Netzkabel oder Netzstecker, falls Flüssigkeiten oder Objekte in das Gerät gelangen, das Gerät Regen oder Feuchtigkeit ausgesetzt wurde, nicht ordnungsgemäß funktioniert oder fallen gelassen wurde.

¡Advertencia! Consulte al personal calificado por cuestiones de reparación. El servicio de reparación se requiere cuando el dispositivo ha recibido cualquier tipo de daño, por ejemplo cable o espigas dañadas, se ha derramado líquido o se han caído objetos dentro del dispositivo, el dispositivo ha sido expuesto a la lluvia o humedad, o no funciona de modo normal, o se ha caído.

Aviso! Remeta todos os serviços de manutenção para o pessoal de assistência qualificado. A prestação de serviços de manutenção é exigida quando o dispositivo foi danificado mediante qualquer forma, como um cabo de alimentação ou ficha que se encontra danificado/a, quando foi derramado líquido ou caíram objectos sobre o dispositivo, quando o dispositivo foi exposto à chuva ou à humidade, quando não funciona normalmente ou quando foi deixado cair.

Avviso! Fare riferimento al personale qualificato per tutti gli interventi di assistenza. L'assistenza è necessaria quando il dispositivo è stato danneggiato in qualche modo, ad esempio se il cavo di alimentazione o la spina sono danneggiati, è stato rovesciato del liquido è stato rovesciato o qualche oggetto è caduto nel dispositivo, il dispositivo è stato esposto a pioggia o umidità, non funziona correttamente o è caduto



Warning! Do not defeat the safety purpose of the polarized or grounding-type plug. A polarized plug has two blades with one wider than the other. A grounding type plug has two blades and a third grounding prong. The wide blade or the third prong are provided for your safety. If the provided plug does not fit into your outlet, consult an electrician for replacement of the obsolete outlet.

Avertissement! La sécurité de la prise polarisée ou de la prise de type mise à la terre ne doit en aucun cas être empêchée de fonctionner. Une prise polarisée a deux broches, l'une étant plus large que l'autre. Une prise de type mise à la terre a deux broches et une troisième broche pour la mise à la terre. La broche large ou la troisième broche sont fournies pour votre sécurité. Si la prise fournie ne s'insère pas dans votre prise femelle, consultez un électricien pour le remplacement de la prise femelle obsolète.

Warnung! Der Sicherheitszweck des gepolten bzw. Schukosteckers ist zu berücksichtigen. Ein gepolter Stecker verfügt über zwei Pole, von denen einer breiter als der andere ist. Ein Schukostecker verfügt neben den zwei Polen noch über einen dritten Pol zur Erdung. Der breite Pol bzw. der Erdungspol dienen der Sicherheit. Wenn der zur Verfügung gestellte Stecker nicht in Ihren Anschluss passt, konsultieren Sie einen Elektriker, um den veralteten Anschluss zu ersetzen.

¡Advertencia! No eche por tierra la finalidad del tipo de enchufe polarizado con conexión a tierra. Un enchufe polarizado tiene dos espigas, una más ancha que la otra. Un enchufe con conexión a tierra tiene dos espigas iguales y una tercera espiga que sirve para la conexión a tierra. La espiga ancha, o la tercera espiga, sirven para su seguridad. Si el enchufe suministrado no encaja en el tomacorriente, consulte con un electricista para reemplazar el tomacorriente obsoleto.

Aviso! Não anule a finalidade da segurança da ficha polarizada ou do tipo ligação terra. Uma ficha polarizada tem duas lâminas sendo uma mais larga do que a outra. Uma ficha do tipo de ligação à terra tem duas lâminas e um terceiro terminal de ligação à terra. A lâmina larga ou o terceiro terminal são fornecidos para sua segurança. Se a ficha fornecida não couber na sua tomada, consulte um electricista para a substituição da tomada obsoleta.

Avviso! Non compromettere la sicurezza della spina polarizzata o con messa a terra. Una spina polarizzata ha due spinotti, di cui uno più largo. Una spina con messa a terra ha due spinotti e un terzo polo per la messa a terra. Lo spinotto largo o il terzo polo sono forniti per motivi di sicurezza. Se la spina fornita non si inserisce nella presa di corrente, contattare un elettricista per la sostituzione della presa obsoleta.



Warning! Disconnect the external AC power supply line cord(s) from the mains power before moving the unit.

Avertissement! Retirez le ou les cordons d'alimentation en CA de la source d'alimentation principale lorsque vous déplacez l'appareil.

Warnung! Trennen Sie die Wechselstrom-Versorgungskabel vom Netzstrom, bevor Sie das Gerät verschieben.

¡Advertencia! Cuando mueva la unidad desenchufe de la red eléctrica el/los cable(s) de la fuente de alimentación CA tipo brick.

Advertência! Remova os cabos CA de alimentação brick da rede elétrica ao mover a unidade.

Avvertenza! Scollegare il cavo dell'alimentatore quando si sposta l'unità.



Warning! Since the Mains plug is used as the disconnection for the device, it must remain readily accessible and operable.

Avertissement! Puisque la prise principale est utilisée pour débrancher l'appareil, elle doit rester aisément accessible et fonctionnelle.

Warnung! Da der Netzstecker als Trennvorrichtung dient, muss er stets zugänglich und funktionsfähig sein.

¡Advertencia! Puesto que el enchufe de la red eléctrica se utiliza como dispositivo de desconexión, debe seguir siendo fácilmente accesible y operable.

Aviso! Dado que a ficha principal é utilizada como a desconexão para o dispositivo, esta deve manter-se prontamente acessível e funcional.

Avviso! Poiché il cavo di alimentazione viene usato come dispositivo di sconnessione, deve rimanere prontamente accessibile e operabile.



Warning! Protect the power cord from being walked on or pinched particularly at plugs, convenience receptacles, and the point where they exit from the device.

Avertissement! Protégez le cordon d'alimentation pour que l'on ne marche pas dessus ou qu'on le pince, en particulier au niveau des prises mâles, des réceptacles de convenance, et à l'endroit où il sort de l'appareil.

Warnung! Vermeiden Sie, dass auf das Netzkabel getreten oder das Kabel geknickt wird, insbesondere an den Steckern, den Steckdosen und am Kabelausgang am Gerät.

¡Advertencia! Proteja el cable de energía para que no se le pise ni apriete, en especial cerca del enchufe, los receptáculos de conveniencia y el punto del que salen del equipo.

Aviso! Proteja o cabo de alimentação de ser pisado ou de ser comprimido particularmente nas fichas, em tomadas de parede de conveniência e no ponto de onde sai do dispositivo.

Avviso! Proteggere il cavo di alimentazione in modo che nessuno ci cammini sopra e che non venga schiacciato soprattutto in corrispondenza delle spine e del punto in cui esce dal dispositivo.

Warranty and Liability Information

AJA VIDEO SYSTEMS, INC.

Limited Warranty on Hardware

AJA Video Systems, Inc. (AJA Video) warrants that the hardware product, not including storage modules or software components, will be free from defects in materials and workmanship for a period of three (3) years from the date of purchase. AJA Video warrants that the storage modules provided as part of the hardware product will be free from defects in materials and workmanship for a period of one year from the date of purchase. AJA Video provides a separate software warranty as part of the license agreement applicable to software components.

If a hardware product or storage module (hereafter, a “product”) proves to be defective during the applicable warranty period, AJA Video, at its option, will either repair the defective product without charge for parts and labor, or will provide a replacement in exchange for the defective product.

To obtain service under this warranty, the Customer must notify AJA Video of the defect before expiration of the warranty period and make suitable arrangements for the performance of service by contacting AJA Video support through the channels set forth on the support contacts web page at <http://www.aja.com/support>. Except as stated, the Customer shall bear all shipping, packing, insurance and other costs, excluding parts and labor, to effectuate repair. Customer shall pack and ship the defective product to a service center designated by AJA Video, with shipping charges prepaid. AJA Video shall pay to return the product to Customer but only if to a location within the country in which the AJA Video service center is located.

This warranty shall not apply to any defect, failure or damage caused by negligent, inadequate or improper use, handling or maintenance. Without limiting the foregoing, AJA Video shall not be obligated to furnish service under this warranty or repair any damage or malfunction a) resulting from attempts by personnel other than AJA Video representatives to install, repair or service the product, b) resulting from improper use or connection to incompatible equipment, c) caused by the use of non-AJA Video parts or supplies, d) if the product has been modified or integrated with other products when the effect of such a modification or integration increases the time or difficulty of servicing the product, or e) resulting from being dropped or otherwise subjected to undue force, exposure to moisture or other corrosive or conductive substances, exposure to strong magnetic fields, use with improperly regulated power supplies, exposure to electric shock, use in temperatures outside the specified operating range, or otherwise failing to treat the product in accordance with the standard of care appropriate to sensitive and delicate electronic equipment.

EXCEPT AS STATED ABOVE, AJA VIDEO AND ITS VENDORS DISCLAIM IN THEIR ENTIRETY ALL OTHER WARRANTIES, EXPRESS OR IMPLIED, INCLUDING WITHOUT LIMITATION ALL WARRANTIES OF MERCHANTABILITY OR FITNESS FOR A PARTICULAR PURPOSE. AJA VIDEO'S RESPONSIBILITY TO REPAIR OR REPLACE TIMELY REPORTED DEFECTIVE PRODUCTS IS THE WHOLE AND EXCLUSIVE REMEDY CUSTOMER IS PROVIDED WITH RESPECT TO HARDWARE PRODUCTS AND THEIR STORAGE MODULES. SOME JURISDICTIONS DO NOT ALLOW THE EXCLUSION OF IMPLIED WARRANTIES OR LIMITATIONS ON APPLICABLE STATUTORY RIGHTS OF A CONSUMER, SO SOME OR ALL OF THE TERMS OF THIS PARAGRAPH MAY NOT APPLY TO YOU.

THE PRODUCT IS NOT INTENDED, STATED, OR WARRANTED TO OPERATE UNINTERRUPTED OR ERROR-FREE. YOU UNDERSTAND AND ACKNOWLEDGE THAT THE PRODUCT IS NOT INTENDED TO BE USED AS THE SOLE OR PRIMARY DATA SOURCE OR TARGET FOR CRITICAL DATA, AND THAT IT IS YOUR RESPONSIBILITY TO IMPLEMENT REDUNDANT CAPTURE AND BACKUP SYSTEMS AS APPROPRIATE.

Limitation of Liability

Under no circumstances shall AJA video BE LIABLE IN ANY WAY FOR ANY LOST, CORRUPTED OR DESTROYED DATA, FOOTAGE OR WORK, OR FOR ANY OTHER INDIRECT, SPECIAL, INCIDENTAL OR CONSEQUENTIAL DAMAGES OR LOST PROFITS, OR FOR ANY THIRD PARTY CLAIM, IN CONNECTION WITH THE PRODUCT, WHETHER RESULTING FROM DEFECTS IN THE PRODUCT, SOFTWARE OR HARDWARE FAILURE, OR ANY OTHER CAUSE WHATSOEVER, EVEN IF AJA VIDEO HAS BEEN ADVISED OF THE POSSIBILITY OF SUCH DAMAGES. AJA VIDEO'S LIABILITY IN CONNECTION WITH THE PRODUCT SHALL UNDER NO CIRCUMSTANCES EXCEED THE PURCHASE PRICE PAID FOR THE PRODUCT. The foregoing limitations apply even if any remedy set forth in this LIMITED WARRANTY fails of its essential purpose. SOME JURISDICTIONS DO NOT ALLOW THE LIMITATION OF LIABILITY FOR PERSONAL INJURY, OR OF INCIDENTAL OR CONSEQUENTIAL DAMAGES, SO SOME OR ALL OF THE TERMS OF THIS PARAGRAPH MAY NOT APPLY TO YOU.

Governing Law and Language; Your Rights.

This limited warranty is the only warranty provided by AJA Video on the hardware product. It supersedes all prior or contemporaneous understandings regarding such subject matter. No amendment to or modification of this warranty will be binding unless in writing and signed by AJA Video. The laws of the State of California, USA will govern this warranty and any dispute arising from it. Any translation of this Agreement is intended for convenience and to meet local requirements and in the event of a dispute between the English and any non-English versions, the English version of this warranty will govern. This limited warranty gives you specific legal rights and you may have other rights that vary from jurisdiction to jurisdiction, some of which are noted above.

Index

Symbols

- 2SI Mode 44
- 2-Wire Mode 44
- 3G Transport 30
- 3rd-Party Plugins 8
- 4K Mode 15
- 4K/UltraHD Transport Modes 43
- 4-Link to 2-Link Switching 54
- 4-Wire Mode 44

A

- AJA Control Panel 7
 - User Interface 18
- AJA Control Panel Overview 17
- AJA Control Room 7
- AJA Input 56
- AJA Software 7
- AJA Support 2
- AJA System Test 7, 10
- AJA Utilities 7
- Alpha Channel 36
- Alpha Channel Key 29
- Analog Audio Output 12
- Analog Audio Pinouts 63
- Analog Black Level 34
- Analog Component 32
- Analog Output
 - Select 32
- Analog Out Screen 32
- Anamorphic 26
- Audio
 - to 4K 6
- Audio Ch 31
- Audio Delay 35
- Audio Input 28
- Audio Level Meters 17
- Audio Mixer Screen 55
- Audio Monitor 34
- Audio Monitoring 45
- Audio Monitoring Routing Diagram 46
- Audio Out 36
- Audio Setup Screen 34

B

- Betacam 13
- Bi-directional SDI I/O 13
- Black Burst 12
- Black Level 34
- Block Diagram Area 18

C

- Cable Connections 11
- Ch Map 28
- Ch Map 28
- Color Meaning 19
- Color Space 29, 31, 33

- Component Video 13
- Component Video Output 13
- Composite 32
- Computer Connection 10
- Connection To Computer 10
- Connectors 13
- Controlling Application 20
- Control Panel 7
 - User Interface 18
- Control Panel UI
 - Color Meaning 19
- Control Room 7
- Control Screen 23
- Control Screen in 4K Mode 46
- Conversion
 - Broadcast Quality 6
- Conversion Icons 20
- Crop 26
- Cross-Conversion 26
- Custom LUT Controls 38

D

- DB-9 Connector 12
- Dedicated SDI HD/SD Output 13
- Default Output 23
- Delay
 - Audio 35
- Digital Primaries 53
- Display Mastering Luminance 53
- Down Conversion 26
- Downstream Keyer 35, 36
- Downstream Keyer in 4K Mode 57
- DS Keyer Screen 35

E

- EBU N10 13
- EOTF 52
- Ext. Color 52

F

- Features 5
- Firmware Screen 42
- Firmware Update Procedure 14
- Firmware Versions 15, 42
- Follow Input 25
- Foreground Pre-Multiplied 36
- Format 32
- Format Conversion 20
- Format Screen 25
- Format Screen in 4K Mode 48
- Framebuffer 19
- Frame Buffer Over Matte 36
- Frame Buffer Over Video In 36
- Freerun 24

G

- Gamma 33
- Genlock 24
- Graphic File Display 24
- Graphic File Load 36
- Graphic Over Frame Buffer 36
- Graphic Over Matte 36
- Graphic over Video In 36

H

- H Crop 26
- HDMI HDR Screen 52
- HDMI Input 11, 31
- HDMI Output 11
- HDMI Screen 30
 - 4K Mode 51, 58
- HDR Mode 52
- HD/SD Output 12
- HD/SD SDI Input 12
- Hold Last App 23
- Horiz and Vert Timing 24
- Host Audio 56
- House Sync 24

I

- Info Screen 43
- Input/Output Icons 19
- Input Passthrough 23
- Input Select Screen 27
- Input Select Screen in 4K Mode 49
- Installation Overview 10
- to 4K Front Panel 16
- to 4K Rear Connectors 11
- to XT Front Panel 16
- to XT Rear Connectors 11

K

- Key
 - Alpha Channel 29
- Keyed Video 36
- Keyer
 - Downstream 35

L

- Letterbox 26
 - SD 26
- LTC Input 12
- LTC/Ref 28
- LUT File 37, 39
 - Format Specification 39
 - Uploading 39
- LUT Gain and Offset Controls 38
- LUT Screen 37
- LUT Type 38

M

- Machine Control 12
- Main App 56
- Matte Color 36
- Maximum Content Light Level (CLL) 53
- Maximum Frame Average Light Level (FALL) 53
- Monitor Channels 34
- Monitor Gain Control 16
- Monitoring 32
- Monitor Level 35
- Monitor Output 16

O

- Opacity 36
- Overview 5

P

- Packing Contents 8
- Pillarbox 26
- Pinouts
 - Analog Audio 63
- Pixel Format 26
- Playback Monitor Mode in 4K Mode 56
- Playback Source Selection 56
- Playback Timing 24
- Power Connector 12
- Power LED 17
- Power Switch 17
- Preferences 21
- Preset
 - Loading 41
 - Reset to Default 41
 - Saving 41
 - Transferring 41
- Presets 20
- Presets Screen 41
- Primary Format 19
- Primary (Frame Buffer) Format 25
- Progressive Pref 33
- Progressive Segmented Frame 25
- Protocol 31
- PsF 25

Q

- Quadrant Mode 44
- Quad Swap
 - SDI Input 54
 - SDI Output 54

R

- Reference Video 12
 - Match Primary Format 12
- Reference Video Signal 12
- Ref In 24
- RGB Range 26, 29, 31
- RS-422 12

S

- SDI Color Sp 28
- SDI Input Quad Swap 54
- SDI Output 1 29
- SDI Output Quad Swap 54
- SDI Output Screen 29
 - 4K Mode 50
- SDI RGB Rng 28
- SD Letterbox 26
- SD to SD Conversion 26
- Secondary (Converted) Format 26
- Secondary Format 19
- Select
 - Analog Output 32
- sf 25
- Shared Preferences 21
- Shared Preferences File Location 21
- Sidebar 26
- Snapshot 41
- Software Download 13
- Software Installation 13
- Software Package Installation 14
- Source Gain 57
- Sync Generator 12
- System Requirements 8
- System Test 7
- System Test Application 13

T

- Technical Support 2
- Test Pattern 23
- Third-Party Application 14
- Thunderbolt Port 12, 13
- Timecode Screen 40
- Timecode Source 40
- Timing
 - Horiz 24
 - Vert 24
- Two Sample Interleave 5

U

- UFC Mode 15
- User Bits 40
- User Preferences 21
- User Preferences File Location 21

V

- VANC Checkbox 34
- V Crop 26
- Video In 24
- Video Input 28
- Video Path 18, 19
- Video Setup 33
- Video Setup Screen 33
 - 4K Mode 54

Y

- Y/C Output 32
- YUV 13

Z

- Zoom 14:9 26
- Zoom Letterbox 26
- Zoom Wide 26