

KUMO

Quick Start Guide



Introduction

This Quick Start Guide provides a basic overview of KUMO system connections and configuration.

KUMO Router Connections

Figure 1. KUMO Rear Panel Connections (3232 shown, other models similar)

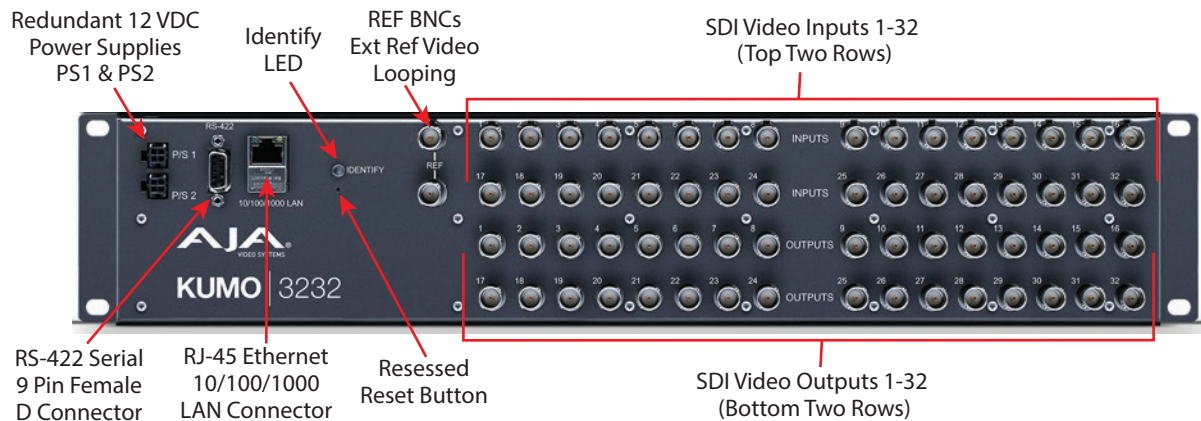

PS 1 & PS 2 Power Connectors

Power to the KUMO unit is supplied by an external power supply module that accepts a 110-220VAC, 50/60Hz power input and supplies +12 VDC to KUMO via connector PS1 or PS2. One power supply is provided, and it may be connected to either of the two power connectors. An optional second power supply can provide redundancy to help protect against outages.

IMPORTANT: The power connector has a latch, similar to an Ethernet connector. Depress the latch (facing the outside edge of the KUMO device) before disconnecting the power cable from the unit.

Power Loss Recovery

If KUMO experiences a loss of power, when power is restored the router returns to the previous state of all source to destination crosspoints, and all configured source and destination names are retained. If a KUMO control panel configured with a KUMO router loses power, when power is restored the control panel's configuration is retained, and button tallies will return to their previous states.

RJ-45 Ethernet Connector

The RJ-45 Ethernet connector allows you to connect KUMO to an Ethernet 10/100/1000 Ethernet LAN using CAT5 cable and access KUMO's built in web server. Multiple configurations are possible, including standalone control, a local LAN, or a WAN. This also allows control over the network using GVG Native Protocol.

ID and Reset

The ID (Identification) LED lights when you use the web interface to identify the KUMO unit you are controlling. The Reset button (pinhole) below the LED allows a safeboot reset of the unit.

REF BNC Connector

The REF BNC connector is the looping input for synchronizing the crosspoint switch timing of KUMO to your house video signals. Apply an analog NTSC, PAL, or Tri-level sync signal to this input. Be sure to terminate the second BNC with a 75 Ohm terminator, or if you loop to other equipment terminate the last connected device.

When reference is present, KUMO will switch at the SMPTE RP168 designated switch point with respect to the reference input. If no reference is present, the KUMO will switch at random times.

Video Inputs and Outputs

Depending on your KUMO model, up to 64 SDI video inputs and outputs can be connected to the video input and output BNC connectors.

Normal Mode

In Normal mode, BNC inputs and outputs have a one-to-one relationship with the SDI signals being routed.

Dual and Quad Modes

In Dual mode, inputs and outputs use adjacent pairs of BNCs for each routed signal. In Quad mode, four adjacent BNCs are used for each routed signal.

RS-422 Connector

KUMO includes an RS-422 female DB-9 connector for making serial connections to other equipment. This control connection enables interoperability with other devices, including those that use GVG Native Protocol.

Older Model RS-422 Adapter

Older KUMO 1604, 1616, and 3232 routers (serial numbers ending in -R0) needed an RS-422 adapter for proper serial control operation (*Figure 2*). This adapter was shipped with those older model routers. Be aware of this fact if your facility has a mixture of older and newer KUMO routers that use RS-422 control.

NOTE: Only older KUMO 1604, 1616, and 3232 routers with a serial number ending in -R0 require this adapter. KUMO routers with serial numbers ending in -R1 or higher do NOT require the adapter. This adapter is also NOT needed for any KUMO 6464 model router.

Figure 2. RS-422 Adapter

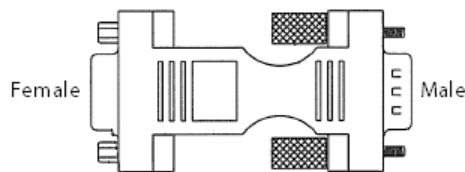

KUMO Control Panel Connections

Similar to the KUMO router, KUMO CP has an RJ-45 Ethernet connector and power supply connectors, but has no BNC connectors and no RS-422 port.

Quick Start Configuration

Default Auto Configure KUMO Router and CP

If you purchased a KUMO CP along with a KUMO 1604, 1616, or 3232 router, the easiest way to get your system operating is to simply direct connect them with a single Ethernet cable and power up both units. KUMO devices are compatible with both CAT-5 straight-through and cross-over Ethernet cables. The KUMO CP will use an Auto Configure function to set itself up to operate with the KUMO router it is directly connected to. The KUMO CP panel buttons will light and, if SDI BNC connections have been made, you will be able to route sources to destinations.

Figure 3. KUMO Router Direct Connection to KUMO CP

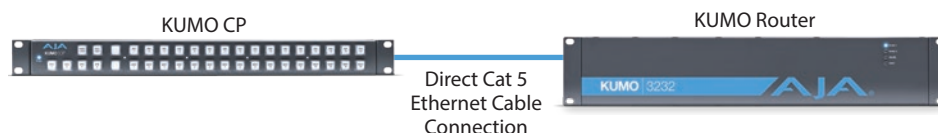

The KUMO CP Auto Configure assigns Router Select Button 1 to the attached router.

*NOTE: A KUMO CP that has had its network settings configured previously will not automatically configure to find a directly connected KUMO router. However, you can force the KUMO CP to reset its Auto Configure by pressing the **RTR 1** and **SHIFT DEST** buttons simultaneously for four seconds.*

DHCP on an Existing Network

Another easy way to get your KUMO system operating is to connect KUMO routers to an existing network configured with a DHCP server. When the units reset during power up, they will see the DHCP server and automatically be given compatible IP network settings. If auto discovery is configured on a computer on that network, that computer will be able to find and control the KUMO router via a web browser (see below).

Computer Auto Discovery

Computers can support network auto discovery, which makes the network configuration process easy. Two methods of connecting using this technique are described below.

Mac Configuration with Safari Browser Using Bonjour

The Mac OSX Safari browser has Bonjour built-in, which can be used to auto-detect and connect to an Ethernet device like a KUMO Router. To do so:

1. Ensure the KUMO to be controlled is powered up and connected via Ethernet (directly to a Mac or via LAN).
2. Start Safari browser on a Mac.
3. Click on the top menu Bookmark->Bonjour->Webpages drop-down and click on a listed AJA KUMO router or control panel.

NOTE: If Bonjour is not visible in the Bookmark drop-down, go to Safari->Preferences->Advanced and check the "Include Bonjour in the Bookmarks menu" checkbox.

4. Safari will display the KUMO web user-interface, which you can use to control and configure that KUMO device.

Windows PC Configuration using UPnP

If your Windows PC supports UPnP protocols (most do) and UPnP network discovery service is enabled (refer to your Microsoft Windows documentation), you can control KUMO routers by simply selecting one from a device list:

1. Ensure the KUMO to be controlled is powered up and connected via Ethernet (directly to the PC or via LAN).
2. Use your Windows Control Panel or File Explorer to go to Computer->Network.
3. Look at the list under "Other Devices"—double click a KUMO's name to launch your Windows PC's default browser.
4. The browser will display the KUMO web user-interface, which you can use to control and configure that KUMO device.

KUMO Temporary Static IP Address

KUMO devices also offer a factory default static IP address, allowing a direct and fail-safe way to connect via a computer connected to KUMO either directly or via a LAN connection. The computer you use will need to be set to a static IP address that is compatible with the KUMO temporary IP address. Once connected, the KUMO device's network settings can be reconfigured to work with your facility network. The KUMO default static IP address is temporary and is intended only to allow an initial connection.

NOTE: All KUMO routers and control panels have the same temporary static IP address, so more than one device set to this default cannot reside on the same network simultaneously. Work with only one device at a time.

Table 1. KUMO Device Temporary Static IP Address Values

Device	IP address	Subnet Mask
KUMO Router and KUMO CP	192.168.101.1	255.255.255.0

NOTE: The default static address is temporary and will be disabled the next time KUMO restarts. Any changes in the Network configuration will be saved upon restart.

To set KUMO to its temporary static IP address:

1. Power up the KUMO device and wait for it to boot normally.
2. Set the KUMO device to its static IP address:
 - For a KUMO router, insert a straightened paper clip or similar device into the reset slot on the rear and hold for five seconds and then release. The KUMO will restart with the default IP. When the KUMO router default IP is set the Identify LED will blink.
 - For a KUMO CP, press and hold the two SHIFT buttons on the panel for five seconds and then release. When the KUMO CP default IP is set, the Source and Destination buttons will flash alternately.

Figure 4. KUMO Router and KUMO CP Default Static IP Setting

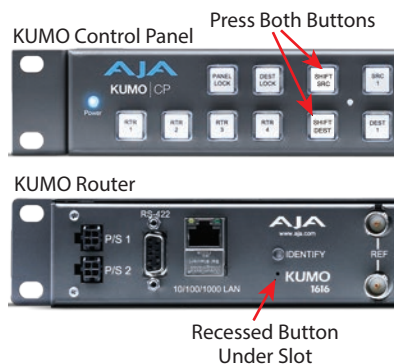

IMPORTANT: Be sure to record your computer's existing TCP-IP settings before the next step so that you can return the computer to normal operation after this procedure.

1. Configure your computer to 192.168.101.X. Do not use .1 at the end of the address to avoid duplicate IP addresses.
2. Start a web browser and enter 192.168.101.1 as the web address. This is the KUMO temporary static IP address.
3. Once you've connected using the static IP, you can then enter a desired network configuration using the KUMO device's Network tab.

Larger System Control Configurations

Figure 5. Multiple KUMO Routers and KUMO CPs with Web Browser UI Control.

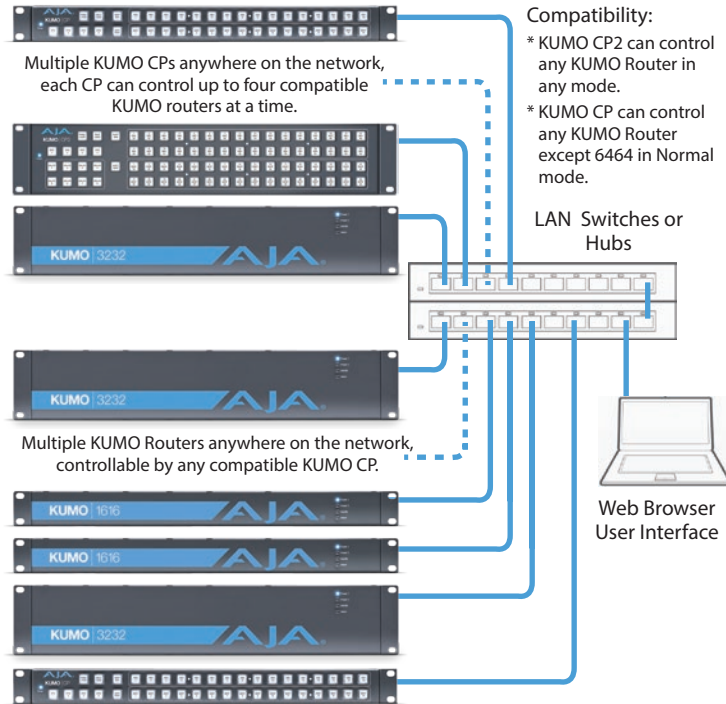

NOTE: The 32 button KUMO CP hardware Control Panel cannot be used with a KUMO 6464 router operating in Normal mode (only 32 buttons for 64 sources and destinations). However the KUMO CP can be used when the KUMO 6464 is operating in Dual or Quad mode. Control of the KUMO 6464 router in all modes is available via the KUMO CP2 64 button hardware panel, web browser, Ethernet control, and RS-422.

If the KUMO will be attached to a WAN, talk to your IT administrator and obtain the details on how to configure the KUMO (DHCP or static IP).

TCP-IP Network Connection

KUMO supports traditional TCP-IP networking through DHCP or Static IP addressing.

IMPORTANT: When using KUMO in a DHCP or Static IP addressed network, it is best to select and maintain a consistent network scheme. If a mixture of DHCP and Static IP addresses are used, inconsistent performance can result. The most stable operation is achieved when all IP addressing is either DHCP or Static.

Default DHCP Configuration

DHCP is the default initial configuration routine for KUMO devices. If you start up on a DHCP network, KUMO will accept assigned IP addresses. After DHCP initialization, use your zeroconf browser to view the KUMO web page and view the assigned IP address.

Static IP Configuration

If your IT administrator prefers an assigned IP address that is fixed (called a “Static IP”), you will need to set network parameters using the KUMO UI Network screen where you will enter:

- IP address type—Static IP
- a unique IP address
- the Subnet Mask and default gateway IP address (your LAN’s router that does the network’s routing)

You will need to press the Enter key on the keyboard for every field changed. Press the **Update Network Settings** button when all fields are complete.

Figure 6. KUMO User Interface Network Tab

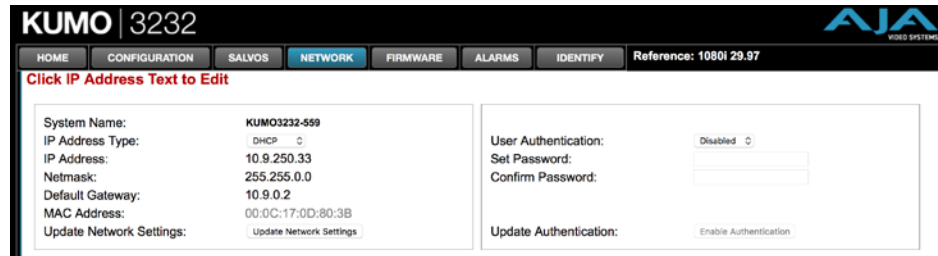

Select KUMO to Control from Web Page

Each KUMO device has a built in web server that generates a web page. KUMO devices see each other on the network and list those other KUMO devices in their web pages. From the Home screen, use the pulldown menu in the upper left to see all of the KUMO devices present on the local LAN and select the router you want to control, or select the KUMO CP you want to use.

Figure 7. KUMO Router Selection



Assign KUMO CP and CP2 to Control KUMO Routers

With multiple KUMO routers and KUMO control panels on the same network, you can assign which routers are able to be controlled by a panel by configuring the four Router Select buttons on the panel. On the KUMO control panel web page, go to the Home screen, click on the box below the RTR button, and select the KUMO router from the drop-down list.

Figure 8. KUMO Control Panel Router Button Assignment

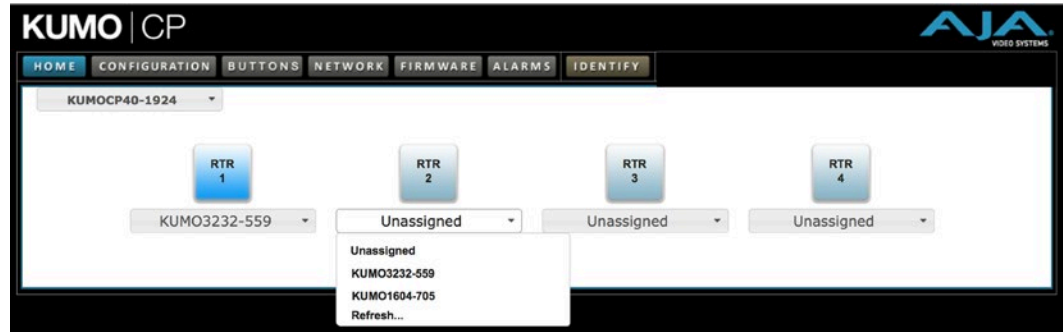

Locating a Specific KUMO Device on the Network

Identify Button

Click on the web UI Identify button to find the physical location of the currently controlled KUMO router or panel.



The web browser button will alternate between blue and gray background color in Identify mode. Click again to turn the Identify function off.

- On a KUMO router, the Identify LEDs on the front and back will flash, enabling quick physical location of the router in a populated rack of equipment.
- On a KUMO CP, the Source and Destination button rows will flash alternately.

Figure 9. KUMO Router Identify LEDs.

