

RD10MD

Dual HD to SD Down Converter R-series Card Module

User Manual



AJA
AJA VIDEO SYSTEMS INC

March 30, 2006 P/N 101665-00

Trademarks

AJA, Io, and Kona are trademarks of AJA Video, Inc. All other trademarks are the property of their respective holders.

Notice

Copyright © 2006 AJA Video, Inc. All rights reserved. All information in this manual is subject to change without notice. No part of the document may be reproduced or transmitted in any form, or by any means, electronic or mechanical, including photocopying or recording, without the express written permission of AJA Inc.

FCC Emission Information

This equipment has been tested and found to comply with the limits for a Class A digital device, pursuant to Part 15 of the FCC Rules. These limits are designed to provide reasonable protection against harmful interference when the equipment is operated in a commercial environment. This equipment generates, uses and can radiate radio frequency energy and, if not installed and used in accordance with the instruction manual, may cause harmful interference to radio communications. Operation of this equipment in a residential area is likely to cause harmful interference in which case the user will be required to correct the interference at his own expense. Changes or modifications not expressly approved by AJA Video can effect emission compliance and could void the user's authority to operate this equipment.

Contacting Support

To contact AJA Video for sales or support, use any of the following methods:

443 Crown Point Circle, Grass Valley, CA. 95945 USA

Telephone: +1.800.251.4224 or +1.530.274.2048

Fax: +1.530.274.9442

Web: <http://www.aja.com>

Support Email: support@aja.com

Sales Email: sales@aja.com

When calling for support, have all information on the product (serial number etc.) at hand prior to calling.

Limited Warranty

AJA Video warrants that this product will be free from defects in materials and workmanship for a period of five years from the date of purchase. If a product proves to be defective during this warranty period, AJA Video, at its option, will either repair the defective product without charge for parts and labor, or will provide a replacement in exchange for the defective product.

In order to obtain service under this warranty, you the Customer, must notify AJA Video of the defect before the expiration of the warranty period and make suitable arrangements for the performance of service. The Customer shall be responsible for packaging and shipping the defective product to a designated service center nominated by AJA Video, with shipping charges prepaid. AJA Video shall pay for the return of the product to the Customer if the shipment is to a location within the country in which the AJA Video service center is located. Customer shall be responsible for paying all shipping charges, insurance, duties, taxes, and any other charges for products returned to any other locations.

This warranty shall not apply to any defect, failure or damage caused by improper use or improper or inadequate maintenance and care. AJA Video shall not be obligated to furnish service under this warranty a) to repair damage resulting from attempts by personnel other than AJA Video representatives to install, repair or service the product, b) to repair damage resulting from improper use or connection to incompatible equipment, c) to repair any damage or malfunction caused by the use of non-AJA Video parts or supplies, or d) to service a product that has been modified or integrated with other products when the effect of such a modification or integration increases the time or difficulty of servicing the product.

THIS WARRANTY IS GIVEN BY AJA VIDEO IN LIEU OF ANY OTHER WARRANTIES, EXPRESS OR IMPLIED. AJA VIDEO AND ITS VENDORS DISCLAIM ANY IMPLIED WARRANTIES OF MERCHANTABILITY OR FITNESS FOR A PARTICULAR PURPOSE. AJA VIDEO'S RESPONSIBILITY TO REPAIR OR REPLACE DEFECTIVE PRODUCTS IS THE WHOLE AND EXCLUSIVE REMEDY PROVIDED TO THE CUSTOMER FOR ANY INDIRECT, SPECIAL, INCIDENTAL OR CONSEQUENTIAL DAMAGES IRRESPECTIVE OF WHETHER AJA VIDEO OR THE VENDOR HAS ADVANCE NOTICE OF THE POSSIBILITY OF SUCH DAMAGES.

Introduction

The RD10MD is a 10-bit broadcast-quality Dual channel HD down converter. Channels 1 and 2 are fully independent. Channel 1 has 2 re-clocked HD/SD-SDI outputs and channel 2 has 1 re-clocked HD/SD-SDI output. Both Channel 1 and 2 have 2 down converted outputs, which can be independently configured as SDI or composite analog. All HD formats are supported including 24p/psf with 3:2 pulldown. The SD output can be formatted for either 4:3 or 16:9 monitors. For 4:3 monitors both Letterbox and Crop modes are supported. The RD10MD is dual-rate (HD/SD) and supports SDI inputs.

The RD10MD is compatible with AJA's FR1 or FR2 frames.

Features

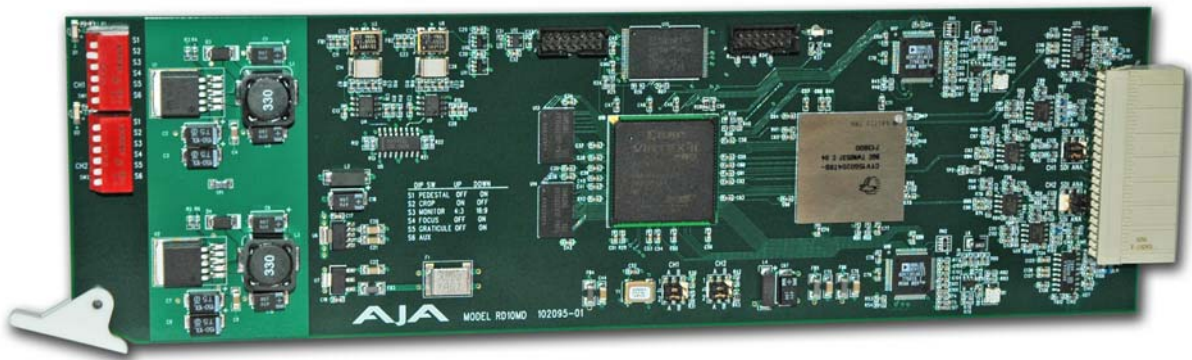

RD10MD Card Module, Side View

- Dual Independent Channel HD to SD Down Conversion
- Re-clocking HD-SDI/SDI input loop outputs
- Multi-Standard HD-SDI or SDI Input
- SDI and Composite Analog Outputs
- 3/2 Pulldown for 23.98/24 Hz P/PSF inputs
- Full 10-bit Data Path, Multi-point Interpolation
- Configurable for 16:9 or 4:3 Monitors
- Letterbox and Crop Modes
- 4:3 Safe-Zone Graticule
- Pedestal on Composite Analog Outputs

Block Diagram

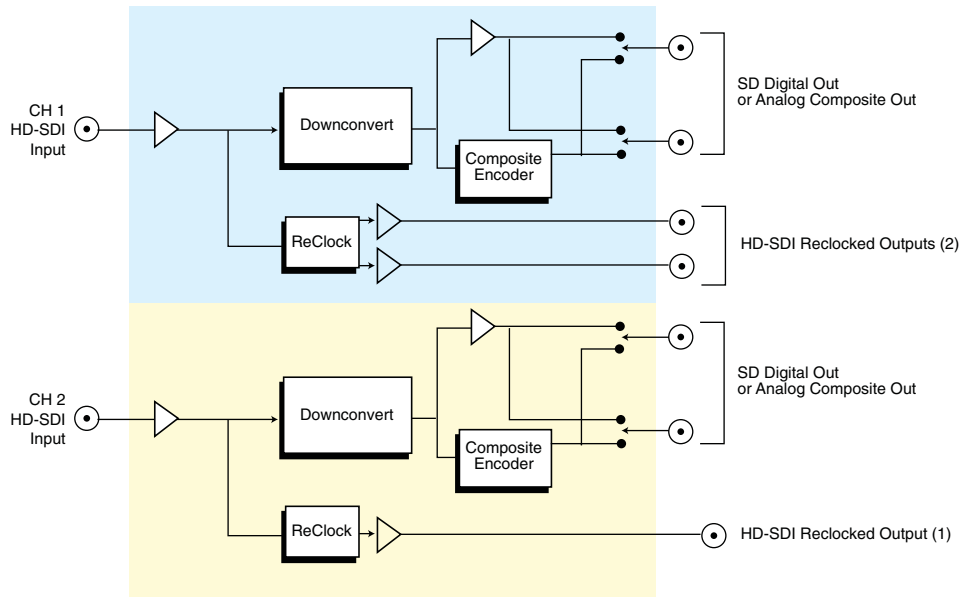

RD10MD, Block Diagram

I/O Connections

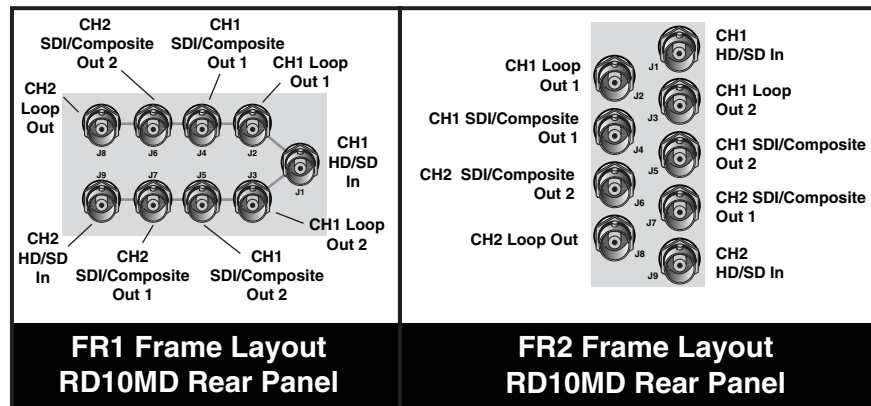

FR1 and FR2 BNC Connector Assignments, RD10MD Card Module

When the RD10MD module is installed in an AJA FR1 or FR2 frame, a corresponding group of 9 BNCs on the rear panel then provide I/O for the module. The illustration above shows the connector assignments for both the FR1 and FR2 when used with the RD10MD.

Output configuration is discussed next in *User Controls*.

User Controls

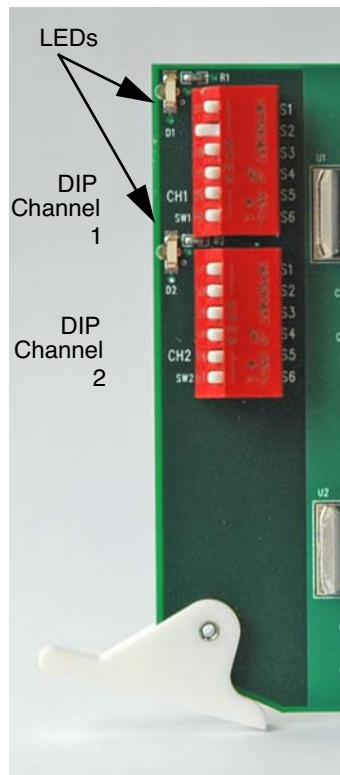

The user interface for configuring the RD10MD and selecting output formats is a pair of dipswitches at the front of the card and several jumpers in the middle and at the back of the card (see J2, J3, J5, and J6 in the photo below).

Two multi-color LEDs at the front of the card additionally show the type of input present at each channel (HD=Orange or SD=Green).

The loop outputs always reflect the reclocked input. Channel 1 has two reclocked looped outputs, while Channel 2 has only one.

The format of the downconverter outputs, either SDI or analog composite, are configured by the jumpers J5 and J6. Jumpers J2 and J3 configure the HD to SD delay and the type of embedded timecode (RP188 or RP215). Tables later in the manual define the jumper settings and their corresponding meanings.

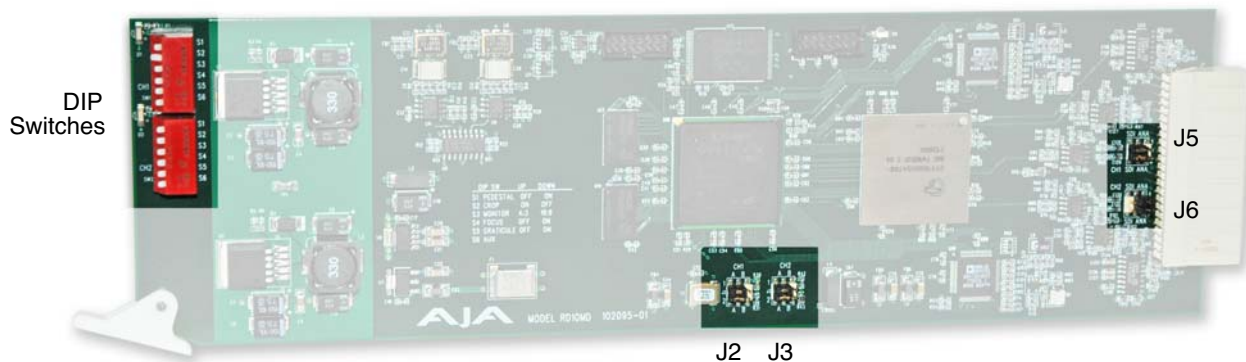

RD10MD Card Module, User Controls

DIP Switch Settings

There is a separate 6-position dipswitch for each channel that controls a number of configuration settings for the RD10MD card. The top dipswitch controls channel 1 and the one beneath it, channel 2. Settings are the same for both dipswitches. These are described in the following table.

Switch Number	Description	Details
1	Pedestal	UP = Pedestal Off DOWN = Pedestal On
2	Crop	UP = Crop On—the Horizontal Edges are cropped off from the input lines; all output lines are used DOWN = Crop Off—black bars are on top and bottom; all of the input line is visible horizontally
3	Monitor	UP = 4:3 monitor DOWN = 16:9 monitor
4	Focus	UP = Off, not in focus mode DOWN = On, in focus mode: passes the middle 720 pixels and 486 lines without filtering
5	Graticule	UP= Graticule Off DOWN = Display Graticule showing safe area for 4:3 material on the 16:9 raster
6	AUX	Unused

Jumper Settings

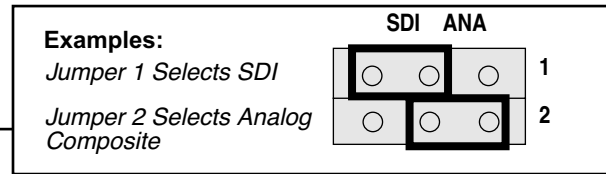
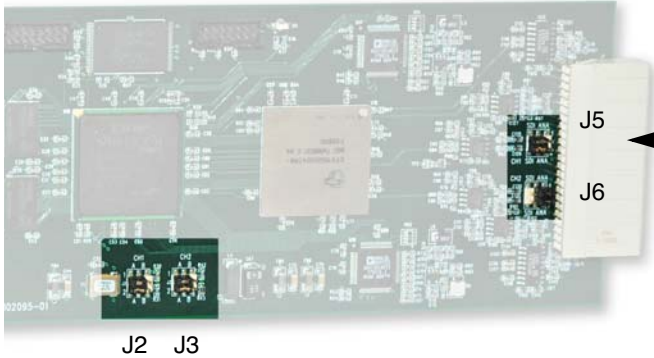

Jumpers J5 & J6 select SDI or Analog Output.
J5 configures Channel 1 Output
J6 configures Channel 2 Output

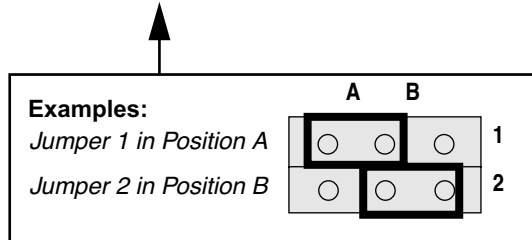

Jumpers J2 & J3 set Delay and Timecode Type
J2 configures Channel 1 Output
J3 configures Channel 2 Output

RD10MD Card Module, Jumper Settings

Jumper	Meaning of Settings
J2 Channel 1	<p>Jumper placed in 1A: Sets Channel 1 HD to SD delay to align with VSYNC (per Panasonic deck)</p> <p>Jumper placed in 1B: Sets Channel 1 HD to SD delay to align with the end of active (per Nvision gen)</p> <p>Jumper placed in 2A: Select Channel 1 to have RP188 embedded timecode</p> <p>Jumper placed in 2B: Select Channel 1 to have RP215 embedded timecode</p>
J3 Channel 2	<p>Jumper placed in 1A: Sets Channel 2 HD to SD delay to align with VSYNC (per Panasonic deck)</p> <p>Jumper placed in 1B: Sets Channel 2 HD to SD delay to align with the end of active (per Nvision gen)</p> <p>Jumper placed in 2A: Select Channel 2 to have RP188 embedded timecode</p> <p>Jumper placed in 2B: Select Channel 2 to have RP215 embedded timecode</p>
J5 Channel 1	<p>Jumper placed in 1 SDI: Set Channel 1 output 1 to SDI</p> <p>Jumper placed in 1 ANA: Set Channel 1 output 1 to Analog Composite</p> <p>Jumper placed in 2 SDI: Set Channel 1 output 2 to SDI</p> <p>Jumper placed in 2 ANA: Set Channel 1 output 2 to Analog Composite</p>
J6 Channel 2	<p>Jumper placed in 1 SDI: Set Channel 2 output 1 to SDI</p> <p>Jumper placed in 1 ANA: Set Channel 2 output 1 to Analog Composite</p> <p>Jumper placed in 2 SDI: Set Channel 2 output 2 to SDI</p> <p>Jumper placed in 2 ANA: Set Channel 2 output 2 to Analog Composite</p>

Installation

Typically, RD10MD installation consists of the following:

1. disconnect power from the frame (remove line cord)
2. remove the FR1/FR2 front panel
3. install RD10MD card module
4. apply power to the frame by connecting a north american-style power cord from the frame to mains power (90 to 260 VAC)

Instructions for removing the frame front door for module installation is discussed in the *FR1/FR2 User Manual*.

Specifications

Item	Specification
Formats:	HD: 1080i 50/59.94/60 Hz 1080p/psf 23.98/24/25/29.97/30 Hz 720p 23.98/24/25/29.97/30/50/60 Hz
Inputs:	2 Channels, HD-SDI or SDI SMPTE 259/292/296, 10-bit, 2x BNC
Outputs:	Each Channel has two outputs configurable for either SDI (SMPTE 259M, 10-bit) or analog composite NTSC/PAL, 2x BNC Channel 1 has two reclocked loop-through outputs, 2x BNC Channel 2 has one reclocked loop-through output, 1 BNC
Downconversion:	Multi-point interpolation, 10-bit processing 3:2 conversion for 23.98/24p/psf inputs
Size:	Fits AJA R-Series Frames
Power Consumption:	7 watts